

MAXIM

单声道2W、D类放大器

概述

MAX9830单声道、2W、D类放大器能够以D类放大器的效率提供AB类放大器的音频性能。

具有有源辐射抑制的边沿速率和过冲控制电路极大地降低了EMI。受专利保护的无滤波、扩展频谱调制方式省去了传统D类器件中常见的输出滤波电路。这些功能可减少系统所需的元件数量。

MAX9830业内领先的低静态电流特性(5V时为1.6mA、3.6V时为1.2mA)可延长便携式设备的电池使用寿命。

MAX9830采用8引脚TDFN (2mm x 2mm x 0.8mm)封装, 工作在-40°C至+85°C扩展级温度范围。

应用

笔记本电脑和上网本计算机
蜂窝电话
MP3播放器
便携式音频播放器
VoIP电话

特性

- ◆ 业内领先的低静态电流特性：5V时为1.6mA、3.6V时为1.2mA
- ◆ 扩展频谱和有源辐射抑制
- ◆ 无滤波放大器采用24in (61cm)扬声器电缆，通过EMI限制标准
- ◆ 217Hz时具有94dB的高PSRR
- ◆ 咔嗒/噤噪声抑制
- ◆ 过热和过流保护
- ◆ 0.5μA低电流关断模式
- ◆ 节省空间的2mm x 2mm x 0.8mm、8引脚TDFN封装

订购信息

PART	TEMP RANGE	PIN-PACKAGE
MAX9830AETA+	-40°C to +85°C	8 TDFN-EP*

+表示无铅(Pb)/符合RoHS标准的封装。

*EP = 裸焊盘。

引脚配置

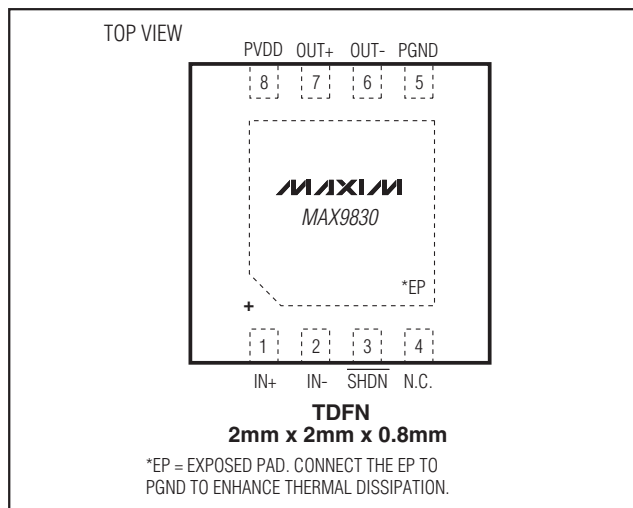

典型工作电路

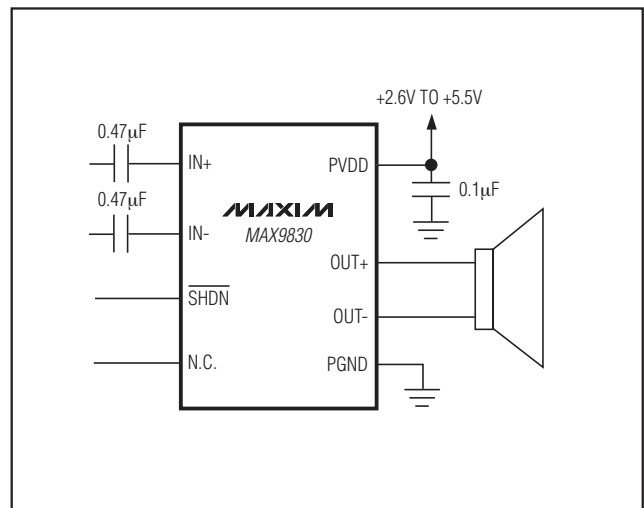

单声道2W、D类放大器

MAX9830

ABSOLUTE MAXIMUM RATINGS

Voltage
 PVDD, IN+, IN-, $\overline{\text{SHDN}}$, to PGND-0.3V to +6V
 OUT+, OUT- to PGND.....-0.3V to $V_{\text{PVDD}} + 0.3\text{V}$
 Current
 Continuous Current Into/Out of PVDD, PGND,
 OUT+, OUT- $\pm 600\text{mA}$
 Continuous Input Current (all other pins) $\pm 20\text{mA}$
 Duration of Short Circuit Between
 OUT+, OUT-, and PVDD, PGNDContinuous

Continuous Power Dissipation for a Multilayer Board
 ($T_A = +70^\circ\text{C}$)
 8-Pin TDFN-EP (derate 11.9mW/ $^\circ\text{C}$)953.5mW
 Junction Temperature+150 $^\circ\text{C}$
 Operating Temperature Range-40 $^\circ\text{C}$ to +85 $^\circ\text{C}$
 Storage Temperature Range-65 $^\circ\text{C}$ to +150 $^\circ\text{C}$
 Lead Temperature (soldering, 10s)+300 $^\circ\text{C}$
 Rate of Voltage Rise at PVDD1V/ μs

Stresses beyond those listed under "Absolute Maximum Ratings" may cause permanent damage to the device. These are stress ratings only, and functional operation of the device at these or any other conditions beyond those indicated in the operational sections of the specifications is not implied. Exposure to absolute maximum rating conditions for extended periods may affect device reliability.

ELECTRICAL CHARACTERISTICS

($V_{\text{PVDD}} = V_{\text{SHDN}} = 5\text{V}$, $V_{\text{PGND}} = 0\text{V}$, $R_L = \infty$, unless otherwise specified. R_L connected between OUT+ and OUT-, AC measurement bandwidth 20Hz to 22kHz, $T_A = T_{\text{MIN}}$ to T_{MAX} , unless otherwise noted. Typical values are at $T_A = +25^\circ\text{C}$.) (Notes 1, 2)

PARAMETER	SYMBOL	CONDITIONS	MIN	TYP	MAX	UNITS	
SPEAKER AMPLIFIER							
Voltage Range	PVDD	Inferred from PSRR test	2.6		5.5	V	
Quiescent Supply Current	I_{DD}	$V_{\text{PVDD}} = 5.0\text{V}$		1.6	2.5	mA	
		$V_{\text{PVDD}} = 3.6\text{V}$		1.2			
Shutdown Supply Current	I_{SHDN}	$V_{\text{SHDN}} = 0\text{V}$, $T_A = +25^\circ\text{C}$		0.5	10	μA	
Turn-On Time	t_{ON}			1.9	4	ms	
Bias Voltage	V_{BIAS}			1.31		V	
Maximum AC Input Voltage	V_{IN}	Single ended		1		V_{RMS}	
		Differential		2			
Input Resistance in Shutdown	R_{INSD}	Between inputs		85.6		$\text{k}\Omega$	
		From inputs to PGND		43			
Input Resistance	R_{IN}		12	20		$\text{k}\Omega$	
Voltage Gain	A_v			12		dB	
Common-Mode Rejection Ratio	CMRR	$f_{\text{IN}} = 1\text{kHz}$, input referred		48		dB	
Power-Supply Rejection Ratio	PSRR	$V_{\text{PVDD}} = 2.6\text{V}$ to 5.5V , $T_A = +25^\circ\text{C}$		54	64.3	dB	
		$PVDD_{\text{RIPPLE}} = 200\text{mV}_{\text{P-P}}$ (Note 3)	$f_{\text{RIPPLE}} = 217\text{Hz}$		94		
			$f_{\text{RIPPLE}} = 20\text{kHz}$		82		
Output Power	P_{OUT}	THD+N = 10%, $f_{\text{IN}} = 1\text{kHz}$	$R_L = 8\Omega$		1.5	W	
			$R_L = 4\Omega$		2.25		
Total Harmonic Distortion Plus Noise	THD+N	$f_{\text{IN}} = 1\text{kHz}$	$R_L = 8\Omega$, $P_{\text{OUT}} = 0.5\text{W}$		0.04	%	
			$R_L = 4\Omega$, $P_{\text{OUT}} = 1\text{W}$		0.04		
Output Offset Voltage	V_{OS}	$T_A = +25^\circ\text{C}$		± 3	± 30	mV	
Click-and-Pop Level	K_{CP}	Peak voltage, A-weighted, 32 samples/sec (Notes 3, 4)	Into shutdown		-56	dBV	
			Out of shutdown		-56		

单声道2W、D类放大器

MAX9830

ELECTRICAL CHARACTERISTICS (continued)

($V_{PVDD} = V_{SHDN} = 5V$, $V_{PGND} = 0V$, $R_L = \infty$, unless otherwise specified. R_L connected between $OUT+$ and $OUT-$, AC measurement bandwidth 20Hz to 22kHz, $T_A = T_{MIN}$ to T_{MAX} , unless otherwise noted. Typical values are at $T_A = +25^\circ C$.) (Notes 1, 2)

PARAMETER	SYMBOL	CONDITIONS	MIN	TYP	MAX	UNITS
Oscillator Frequency	f_{OSC}			600		kHz
Spread-Spectrum Bandwidth				± 10		kHz
Noise	V_N	A-weighted (Note 3)		39		μV_{RMS}
Signal-to-Noise Ratio	SNR	$P_{OUT} = P_{OUT}$ at 1% THD+N, A-weighted $R_L = 8\Omega$		98		dB
Output Current Limit	I_{LIM}	$T_A = +25^\circ C$		3		A
Thermal Shutdown Level				+180		$^\circ C$
Thermal Shutdown Hysteresis				30		$^\circ C$
Efficiency	η	$R_L = 8\Omega$, $P_{OUT} = 1.5W$		85		%
DIGITAL INPUT (SHDN)						
Input Voltage High	V_{IH}		1.4			V
Input Voltage Low	V_{IL}				0.4	V
Input Leakage Current		$T_A = +25^\circ C$			± 10	μA

Note 1: All devices are 100% production tested at $T_A = +25^\circ C$. All temperature limits are guaranteed by design.

Note 2: Testing performed with a resistive load in series with an inductor to simulate an actual speaker load. For $R_L = 4\Omega$, $L = 33\mu H$.
For $R_L = 8\Omega$, $L = 68\mu H$.

Note 3: Amplifier inputs AC-coupled to PGND with $C_{IN} = 0.47\mu F$.

Note 4: Specified at room temperature with an 8Ω resistive load in series with a $68\mu H$ inductive load connected across BTL outputs.
Mode transitions are controlled by SHDN.

单声道2W、D类放大器

典型工作特性

($V_{PVDD} = V_{SHDN} = 5.0V$, $V_{PGND} = 0V$, $R_L = \infty$, unless otherwise specified. R_L connected between OUT+ and OUT-, AC measurement bandwidth 20Hz to 22kHz, $T_A = +25^\circ C$, unless otherwise noted.)

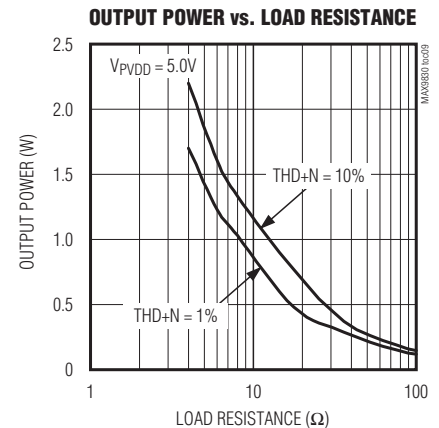
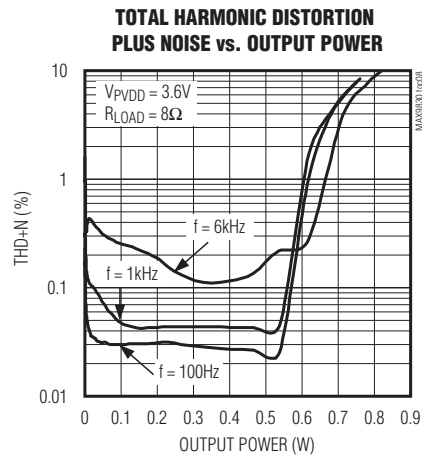
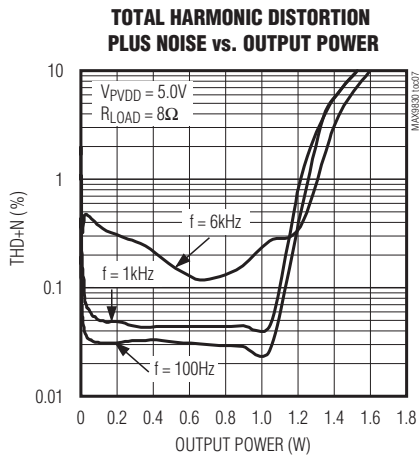
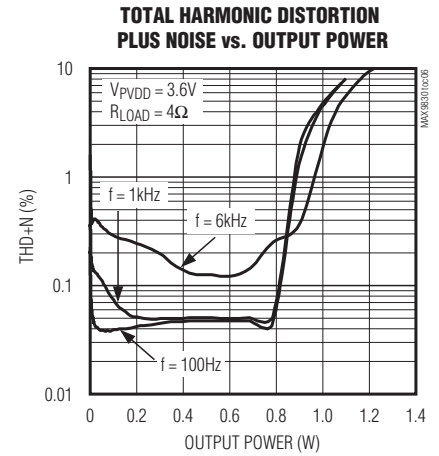
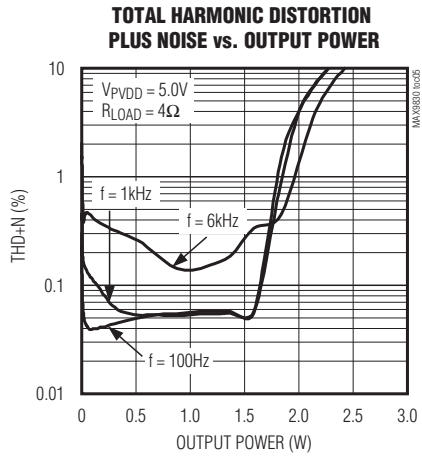
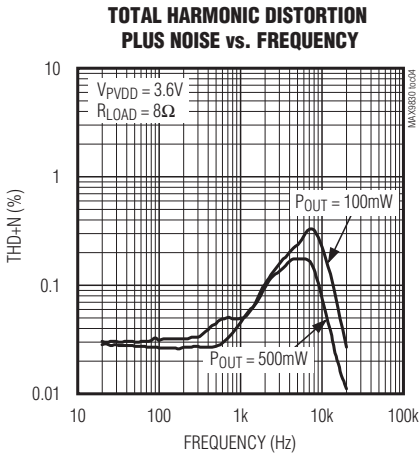
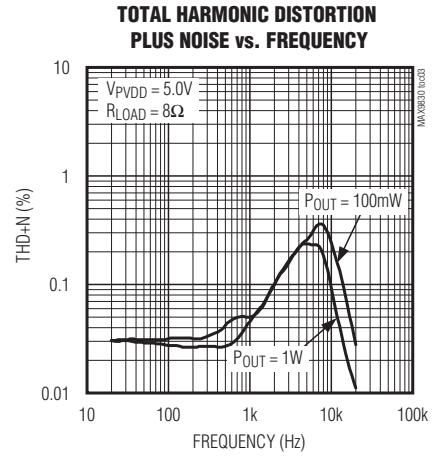
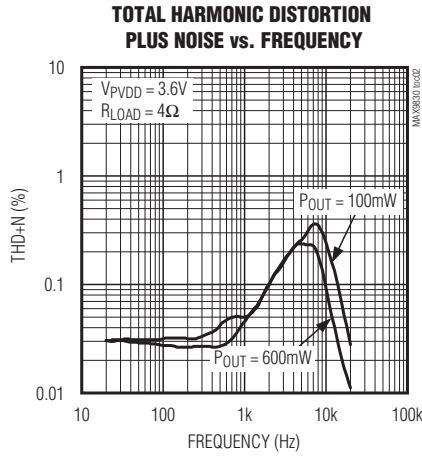
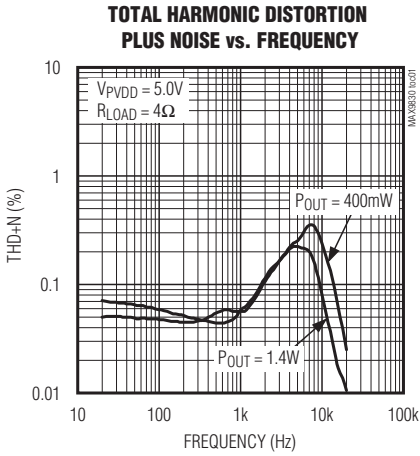

单声道2W、D类放大器

MAX9830

典型工作特性(续)

($V_{PVDD} = V_{SHDN} = 5.0V$, $V_{PGND} = 0V$, $R_L = \infty$, unless otherwise specified. R_L connected between OUT+ and OUT-, AC measurement bandwidth 20Hz to 22kHz, $T_A = +25^\circ C$, unless otherwise noted.)

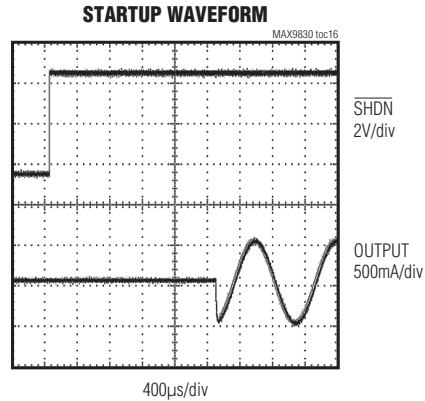
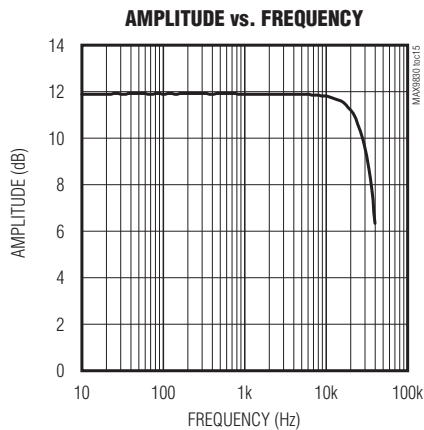
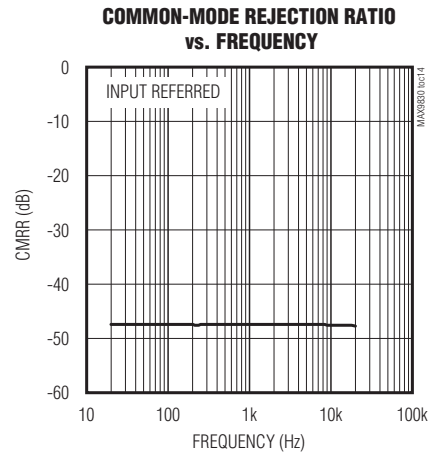
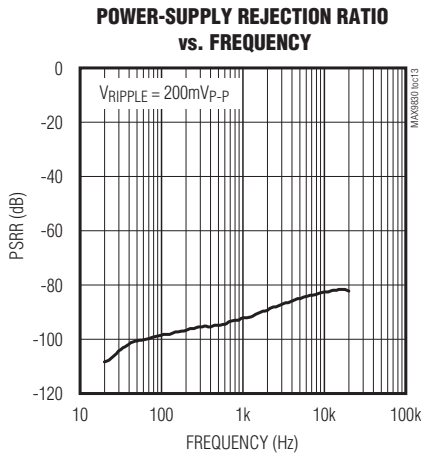
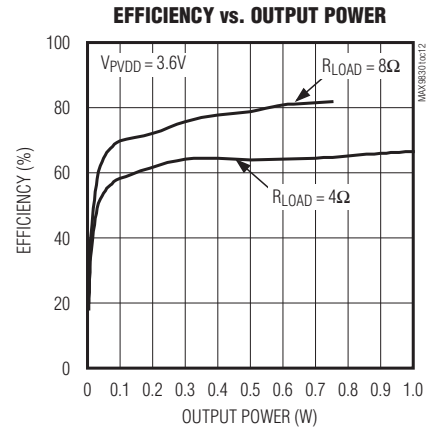
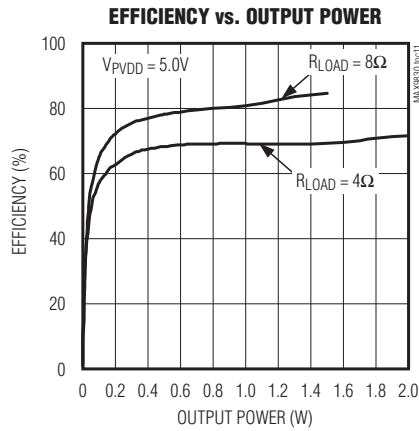
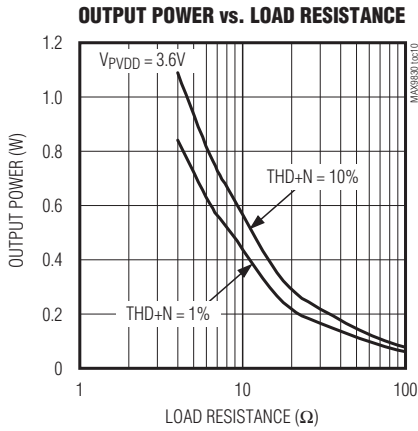

单声道2W、D类放大器

典型工作特性(续)

($V_{PVDD} = V_{SHDN} = 5.0V$, $V_{PGND} = 0V$, $R_L = \infty$, unless otherwise specified. R_L connected between OUT+ and OUT-, AC measurement bandwidth 20Hz to 22kHz, $T_A = +25^\circ C$, unless otherwise noted.)

SHUTDOWN WAVEFORM

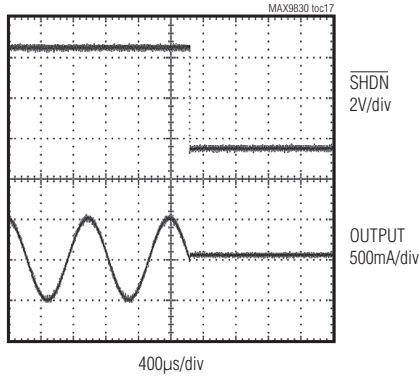

WIDEBAND OUTPUT SPECTRUM

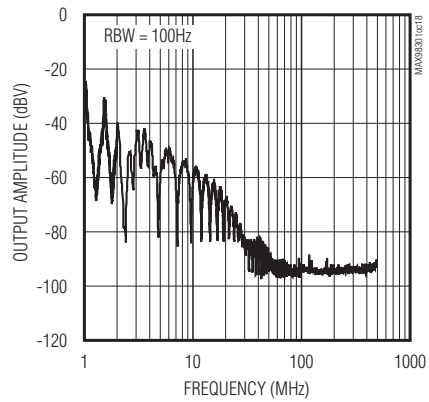

OUTPUT FREQUENCY SPECTRUM

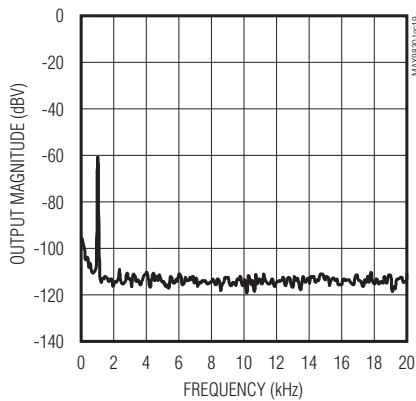

SUPPLY CURRENT vs. SUPPLY VOLTAGE

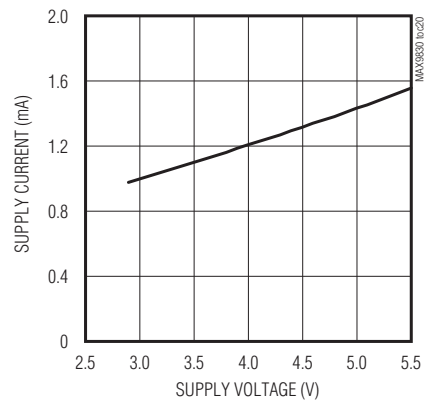

SHUTDOWN CURRENT vs. SUPPLY VOLTAGE

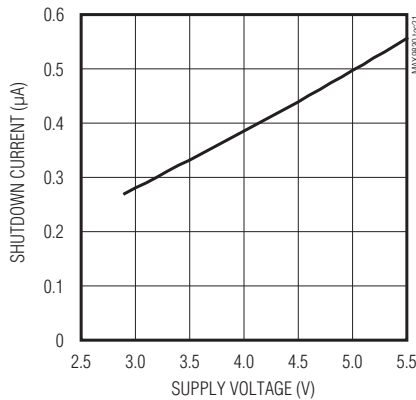

RF IMMUNITY vs. FREQUENCY

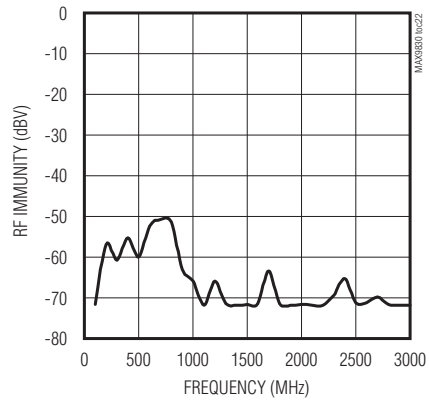

单声道2W、D类放大器

引脚说明

MAX9830

引脚	名称	功能
1	IN+	同相音频输入。
2	IN-	反相音频输入。
3	$\overline{\text{SHDN}}$	低电平有效关断输入，驱动SHDN为低电平，器件将置于关断模式。
4	N.C.	无连接，保持悬空。
5	PGND	地。
6	OUT-	扬声器负端输出。
7	OUT+	扬声器正端输出。
8	PVDD	电源，用一个0.1 μF 电容将PVDD旁路至PGND。
—	EP	裸焊盘，将裸焊盘连接至一个大面积地层。

详细说明

MAX9830具有业内领先的低静态电流、低功耗关断模式，提供完备的咔嗒/噼噗声抑制以及优异的RF抑制。

MAX9830以D类放大器的效率提供AB类放大器的音频性能，占用最小的电路板空间。该D类放大器具有扩展频谱调制方式，结合边沿速率控制和过冲控制电路，显著改善开关模式放大器的电磁辐射性能。

MAX9830具有热过载和短路保护功能。

D类扬声器放大器

MAX9830无滤波D类放大器的效率远远高于AB类放大器。D类放大器的高效率源于输出级晶体管的开关工作。所有与D类放大器输出级相关的功耗几乎都来自于MOSFET的导通电阻和静态电流造成的 I^2R 损耗。

超低EMI无需滤波输出级

传统的D类放大器需要使用外部LC滤波器或采用屏蔽，以满足EN55022B电磁干扰(EMI)规范的要求。Maxim受专利保护的带有源辐射抑制的边沿速率控制电路和扩展频谱调制技术可有效降低EMI辐射，同时还可保持高达85%的工作效率。

Maxim受专利保护的扩展频谱调制模式将频谱分量扩展至较宽频带，同时采用专有技术确保开关周期的逐周期变化不会劣化音频重建或效率。MAX9830的扩展频谱调制器在中心频率(600kHz)附近以 $\pm 10\text{kHz}$ 的幅度随机改变开关频率。高于10MHz时，EMI测试中，宽带频谱类似于噪声频谱(图1)。



图1. 采用24in扬声器电缆时的EMI特性

扬声器限流

如果扬声器放大器的输出电流超过电流门限(典型值为1.8A)，MAX9830将禁止输出大约400 μs 。400 μs 结束后，重新使能输出。如果仍然存在故障条件，MAX9830则继续禁止和重新使能输出的过程，直到故障条件消除。

关断

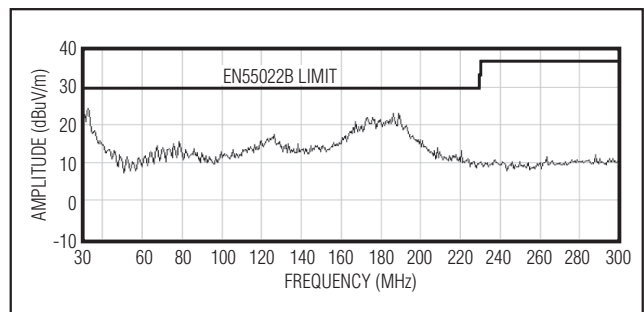
MAX9830具有低功耗关断模式，仅消耗0.5 μA 电源电流。拉低 $\overline{\text{SHDN}}$ ，MAX9830将进入关断模式。

咔嗒/噼噗声抑制

MAX9830扬声器放大器集成了Maxim完备的咔嗒/噼噗声抑制功能。启动期间，咔嗒/噼噗声抑制电路可以降低器件内部的任何瞬态噪声。进入关断模式时，差分扬声器输出将同时快速地线性下降到PGND。

单声道2W、D类放大器

应用信息

无滤波D类放大器工作

传统的D类放大器需要一个输出滤波器。该滤波器会增加成本、增大体积并降低效率和THD+N性能。MAX9830的无滤波调制方案省去了输出滤波器。

由于MAX9830的开关频率超出了绝大多数扬声器的带宽，在开关频率处的音圈移动非常小。使用串联电感 $> 10\mu\text{H}$ 的扬声器，典型的8Ω扬声器的串联电感通常在20μH至100μH范围内。

元件选择

可选择铁氧体磁珠滤波器

通常情况下不需要，但在某些应用中($V_{\text{PVDD}} = 3\text{V}$ 、扬声器引线超过24in时)，连接一个由低成本铁氧体磁珠和小容值对地电容构成的滤波器(图2)，有助于进一步抑制EMI。选择低直流电阻、高频($\geq 1\text{MHz}$)阻抗在100Ω至600Ω、额定电流至少为1A的铁氧体磁珠。根据所使用的铁氧体磁珠和实际扬声器的电缆长度选择不同的电容值，选择电容时还要考虑EMI性能要求。

扬声器放大器电源输入(PVDD)

PVDD为扬声器放大器供电，PVDD的范围为2.6V至5.5V，通过一个0.1μF电容将PVDD旁路至PGND。如果在PVDD和电源之间使用了较长的输入引线，则在器件位置采用



图2. 可选择的铁氧体磁珠滤波器

一个附加的大容量电容，须确保PVDD的电压上升速率限制在1V/μs。

输入滤波

输入耦合电容(C_{IN})与放大器内部的输入电阻(R_{IN})一起构成了一个高通滤波器，可以消除输入信号中的直流偏压。这些电容允许放大器将信号偏置在最佳直流电平。选择0.47μF的电容，以获得最佳的咔嗒/噤噪抑制性能和17Hz的 $f_{-3\text{dB}}$ 。

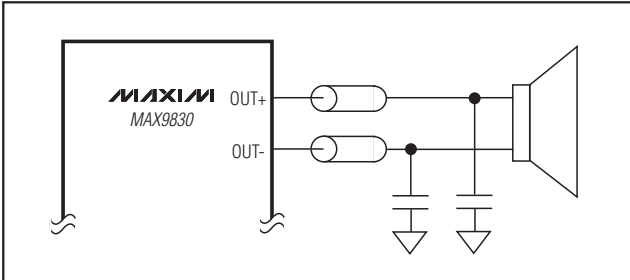
如果需要其它的 $f_{-3\text{dB}}$ ，假设源阻抗为0，则 C_{IN} 为：

$$C_{\text{IN}} = \frac{8}{f_{-3\text{dB}}} [\mu\text{F}]$$

使用电压系数足够低的电容，以获得最佳的低频THD指标。

布局 and 接地

合适的布局和接地对于获得最优性能至关重要。良好的接地可以改善音频性能并防止将开关噪声耦合到音频信号。

使用较宽的低阻输出引线。负载电阻下降时，从器件输出端吸收的电流增大。电流较高时，输出引线电阻会显著降低传送到负载的功率。例如，如果通过100mΩ引线将2W功率从扬声器输出传送到4Ω负载，引线将消耗49mW功率。如果通过10mΩ引线传输功率，引线仅消耗5mW功率。较宽的输出引线、电源和接地引线还有助于改善器件的功耗。

MAX9830设计具有优异的RF抗干扰能力。为获得最佳性能，可在PCB顶层和底层的所有信号线周围铺设接地区域。MAX9830的TDFN封装底部带有一个散热裸焊盘。该焊盘提供了一条从管芯到PCB的导热通路，从而降低了封装热阻。使用一个大焊盘并通过多个过孔将散热裸焊盘连接至地平面。

芯片信息

PROCESS: CMOS

单声道2W、D类放大器

功能框图

MAX9830

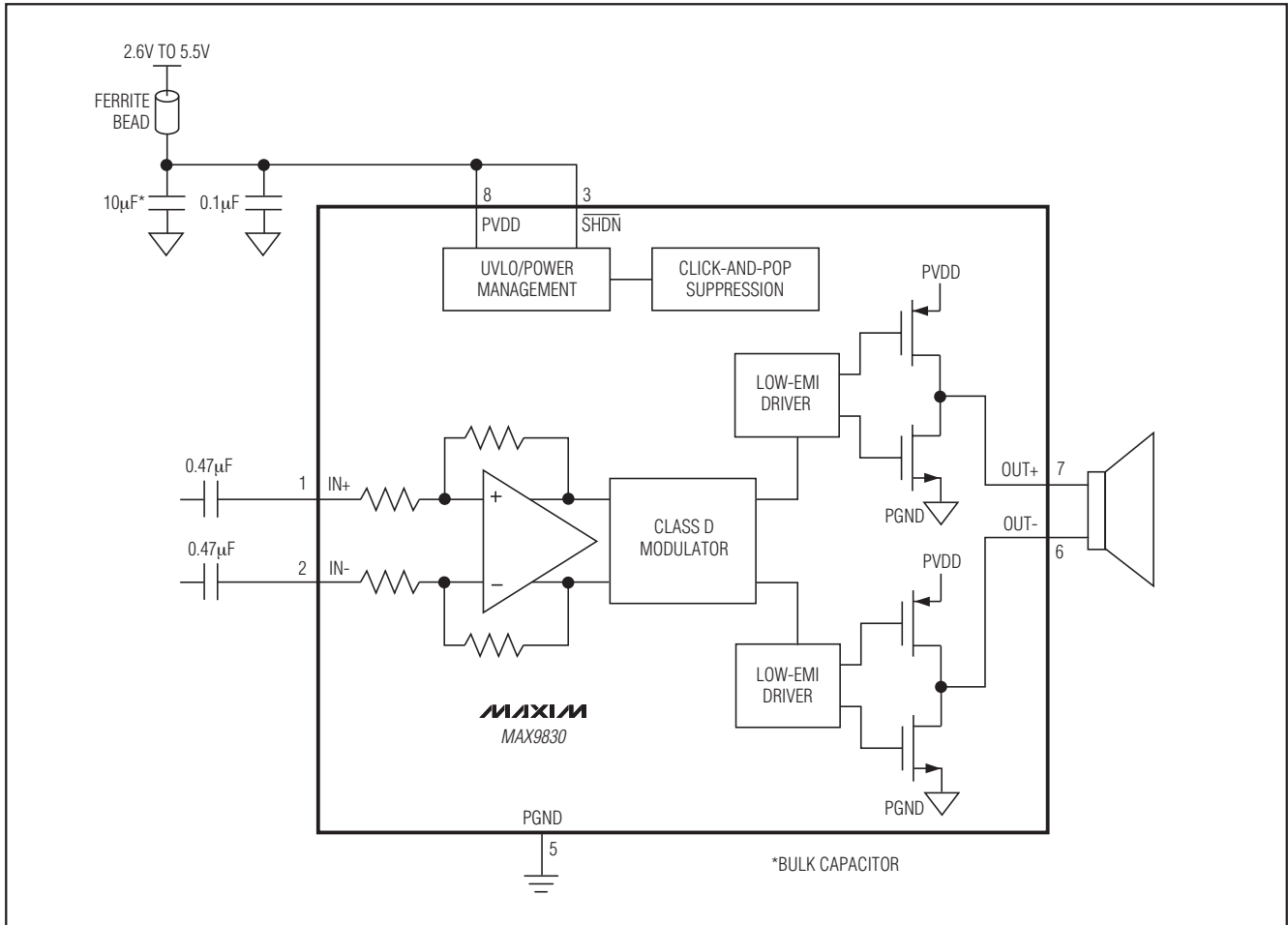

单声道2W、D类放大器

MAX9830

封装信息

如需最近的封装外形信息和焊盘布局, 请查询 china.maxim-ic.com/packages.

封装类型	封装编码	文档编号
8 TDFN-EP	T822+2	21-0168

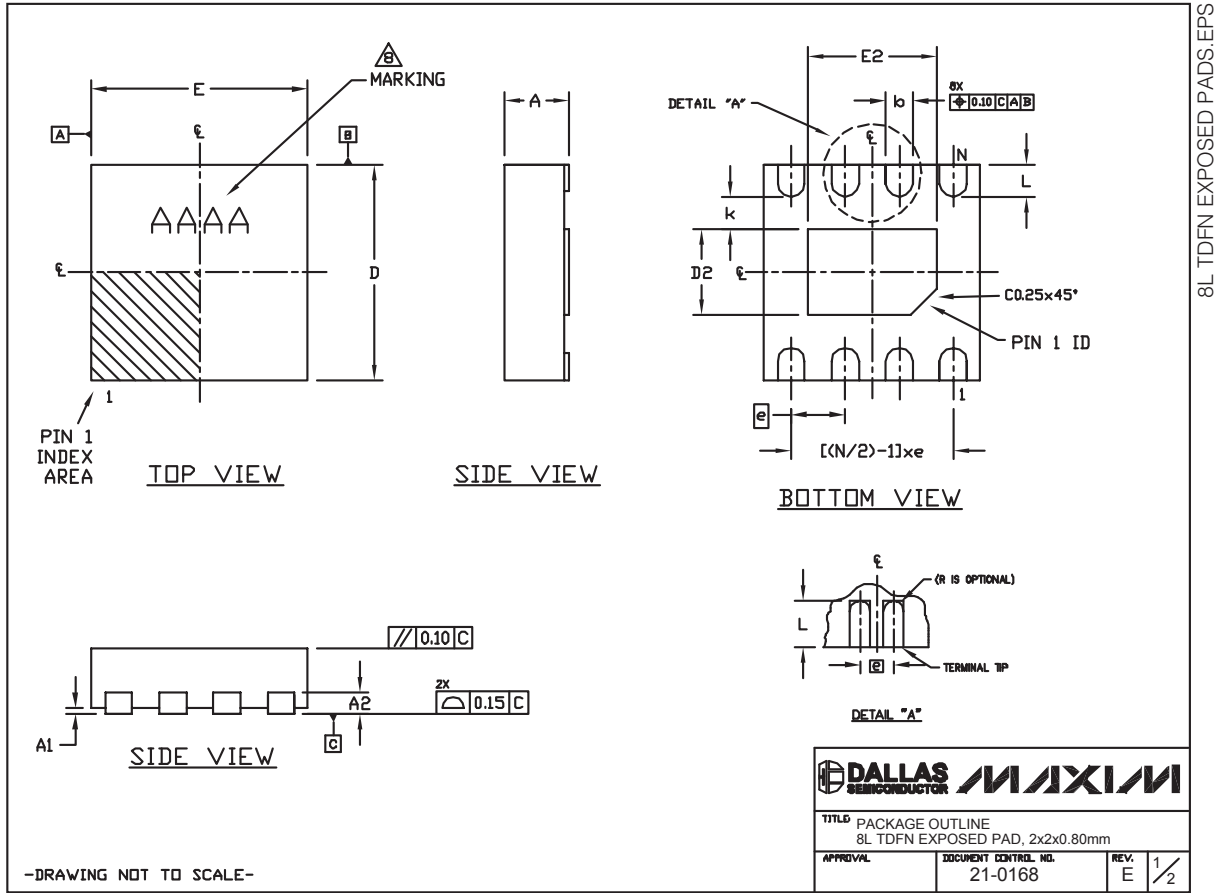

单声道2W、D类放大器

封装信息(续)

如需最近的封装外形信息和焊盘布局, 请查询 china.maxim-ic.com/packages.

MAX9830

COMMON DIMENSIONS		
SYMBOL	MIN.	MAX.
A	0.70	0.80
D	1.90	2.10
E	1.90	2.10
A1	0.00	0.05
L	0.20	0.40
k	0.25 MIN.	
A2	0.20 REF.	

PACKAGE VARIATIONS							
PKG. CODE	N	D2	E2	e	b	r	[(N/2)-1] x e
T822-1	8	0.70-0.10	1.30-0.10	0.50 TYP.	0.25-0.05	0.125	1.50 REF
T822-2	8	0.80-0.10	1.20-0.10	0.50 TYP.	0.25-0.05	0.125	1.50 REF

NOTES:

1. ALL DIMENSIONS ARE IN mm. ANGLES IN DEGREES.
2. COPLANARITY APPLIES TO THE EXPOSED PAD AS WELL AS THE TERMINALS. COPLANARITY SHALL NOT EXCEED 0.08mm.
3. WARPAGE SHALL NOT EXCEED 0.08mm.
4. PACKAGE LENGTH/PACKAGE WIDTH ARE CONSIDERED AS SPECIAL CHARACTERISTIC(S).
5. COMPLY TO JEDEC MO229 EXCEPT D2 AND E2 DIMENSIONS.
6. 'N' IS THE TOTAL NUMBER OF LEADS.
7. NUMBER OF LEADS SHOWN ARE FOR REFERENCE ONLY.
8. MARKING IS FOR PACKAGE ORIENTATION REFERENCE ONLY.
9. ALL DIMENSIONS APPLY TO BOTH LEADED AND PbFREE PARTS.

-DRAWING NOT TO SCALE-

			
TITLE PACKAGE OUTLINE 8L TDFN EXPOSED PAD, 2x2x0.80mm			
APPROVAL	DOCUMENT CONTRL. NO. 21-0168	REV. E	2/2

Maxim北京办事处

北京 8328信箱 邮政编码 100083

免费电话: 800 810 0310

电话: 010-6211 5199

传真: 010-6211 5299

Maxim不对Maxim产品以外的任何电路使用负责, 也不提供其专利许可。Maxim保留在任何时间、没有任何通报的前提下修改产品资料和规格的权利。

Maxim Integrated Products, 120 San Gabriel Drive, Sunnyvale, CA 94086 408-737-7600 _____ 11