



SiGe高线性度、815MHz至1000MHz下变频器， 带有LO缓冲器/开关

MAX9986A

概述

MAX9986A高线性度下变频混频器具有8.2dB增益、+25dBm IIP3和10dB的NF，适用于815MHz至1000MHz基站接收机。该混频器具有960MHz至1180MHz的LO频率范围，适合高边LO注入接收结构。MAX9984支持低边LO注入，并与MAX9986A引脚和功能兼容。

除了具有出色的线性度和噪声性能外，MAX9986A还具有非常高的器件集成度。该器件包括双平衡无源混频器核、IF放大器、双输入LO选择开关以及LO缓冲器。片内还集成了非平衡变压器，可以接收单端RF和LO输入。MAX9986A需要一个额定0dBm的LO驱动，并确保其电源电流低于250mA。

MAX9986A是MAX9986的衍生版本，改善了大信号阻塞指标。MAX9984/MAX9986/MAX9986A与MAX9994/MAX9996 1700MHz至3000MHz混频器引脚兼容，因此，该系列下变频混频器能够采用相同的PC板布局提供双频工作。MAX9986A还与MAX9993功能兼容。

MAX9986A采用紧凑的20引脚、裸焊盘、薄型QFN封装(5mm x 5mm)。在-40°C至+85°C的扩展级温度范围内可保证其电气性能。

应用

850MHz WCDMA 基站
GSM 850/GSM 900、2G和2.5G EDGE 基站
cdmaOne™和cdma2000® 基站
iDEN® 基站
预失真接收机
固定宽带无线接入
无线本地环路
个人移动通信终端
军用设备
微波链路
数字和扩频通信系统

cdma2000是电信工业协会的注册商标。
cdmaOne是CDMA发展组织的商标。
iDEN是Motorola, Inc.的注册商标。

特性

- ◆ 815MHz至1000MHz的RF频率范围
- ◆ 960MHz至1180MHz的LO频率范围 (MAX9986A/MAX9986)
- ◆ 570MHz至850MHz的LO频率范围 (MAX9984)
- ◆ 50MHz至250MHz 的IF频率范围
- ◆ 8.2dB的变换增益
- ◆ +25dBm三阶输入交调截点(IIP3)
- ◆ +14.8dBm输入1dB压缩点
- ◆ 10dB噪声系数
- ◆ $P_{RF} = -10\text{dBm}$ 时，具有69dBc的2LO - 2RF杂散抑制
- ◆ 集成LO缓冲器
- ◆ 集成RF和LO非平衡变压器，用于单端输入
- ◆ -3dBm至+3dBm的LO驱动
- ◆ 内置SPDT LO开关，LO1至LO2隔离度为49dB，切换时间为50ns
- ◆ 与MAX9994/MAX9996 1700MHz到3000MHz混频器引脚兼容
- ◆ 与MAX9993功能兼容
- ◆ 外部电流设置电阻允许选择混频器的低功耗/低性能工作模式
- ◆ 提供无铅封装

订购信息

PART	TEMP RANGE	PIN-PACKAGE	PKG CODE
MAX9986AETP	-40°C to +85°C	20 Thin QFN-EP* 5mm x 5mm	T2055-3
MAX9986AETP-T	-40°C to +85°C	20 Thin QFN-EP* 5mm x 5mm	T2055-3
MAX9986AETP+	-40°C to +85°C	20 Thin QFN-EP* 5mm x 5mm	T2055-3
MAX9986AETP+T	-40°C to +85°C	20 Thin QFN-EP* 5mm x 5mm	T2055-3

*EP = 裸焊盘。
+ = 无铅封装。
T = 卷带包装。

引脚配置/功能框图和典型应用电路在数据资料的最后给出。

SiGe高线性度、815MHz至1000MHz下变频器， 带有LO缓冲器/开关

MAX9986A

ABSOLUTE MAXIMUM RATINGS

V _{CC} to GND.....	-0.3V to +5.5V	θ _{JA}	+38°C/W
IF+, IF-, LOBIAS, LOSEL, IFBIAS to GND...-	0.3V to (V _{CC} + 0.3V)	θ _{JC}	+13°C/W
TAP	-0.3V to +1.4V	Operating Temperature Range (Note A)	T _C = -40°C to +85°C
LO1, LO2, LEXT to GND.....	-0.3V to +0.3V	Junction Temperature	+150°C
RF, LO1, LO2 Input Power	+12dBm	Storage Temperature Range	-65°C to +150°C
RF (RF is DC shorted to GND through a balun)	50mA	Lead Temperature (soldering, 10s)	+300°C
Continuous Power Dissipation (T _A = +70°C) 20-Pin Thin QFN-EP (derate 26.3mW/°C above +70°C).....	2.1W		

Note A: T_C is the temperature on the exposed paddle of the package.

Stresses beyond those listed under "Absolute Maximum Ratings" may cause permanent damage to the device. These are stress ratings only, and functional operation of the device at these or any other conditions beyond those indicated in the operational sections of the specifications is not implied. Exposure to absolute maximum rating conditions for extended periods may affect device reliability.

DC ELECTRICAL CHARACTERISTICS

(MAX9986A Typical Application Circuit, V_{CC} = +4.75V to +5.25V, no RF signal applied, IF+ and IF- outputs pulled up to V_{CC} through inductive chokes, R1 = 953Ω, R2 = 619Ω, T_C = -40°C to +85°C, unless otherwise noted. Typical values are at V_{CC} = +5V, T_C = +25°C, unless otherwise noted.)

PARAMETER	SYMBOL	CONDITIONS	MIN	TYP	MAX	UNITS
Supply Voltage	V _{CC}		4.75	5.00	5.25	V
Supply Current	I _{CC}			213	250	mA
LO_SEL Input-Logic Low	V _{IL}				0.8	V
LO_SEL Input-Logic High	V _{IH}		2			V

AC ELECTRICAL CHARACTERISTICS

(MAX9986A Typical Application Circuit, V_{CC} = +4.75V to +5.25V, RF and LO ports are driven from 50Ω sources, P_{LO} = -3dBm to +3dBm, P_{RF} = -5dBm, f_{RF} = 815MHz to 1000MHz, f_{LO} = 960MHz to 1180MHz, f_{IF} = 160MHz, f_{LO} > f_{RF}, T_C = -40°C to +85°C, unless otherwise noted. Typical values are at V_{CC} = +5V, P_{RF} = -5dBm, P_{LO} = 0dBm, f_{RF} = 910MHz, f_{LO} = 1070MHz, f_{IF} = 160MHz, T_C = +25°C, unless otherwise noted.) (Note 1)

PARAMETER	SYMBOL	CONDITIONS	MIN	TYP	MAX	UNITS
RF Frequency Range	f _{RF}	(Note 2)	815		1000	MHz
LO Frequency Range	f _{LO}	(Note 2)	960		1180	MHz
		MAX9984	570		850	
IF Frequency Range	f _{IF}	(Note 2)	50		250	MHz
Conversion Gain	G _C	T _C = +25°C	7.2	8.2	9.3	dB
Gain Variation Over Temperature		T _C = -40°C to +85°C		-0.009		dB/°C
Conversion Gain Flatness		Flatness over any one of three frequency bands: f _{RF} = 824MHz to 849MHz f _{RF} = 869MHz to 894MHz f _{RF} = 880MHz to 915MHz		±0.15		dB
Input Compression Point	P _{1dB}	(Note 3)		14.8		dBm
Input Third-Order Intercept Point	IIP3	Two tones: f _{RF1} = 910MHz, f _{RF2} = 911MHz, P _{RF} = -5dBm/tone, f _{LO} = 1070MHz, P _{LO} = 0dBm, T _A = +25°C	22	25		dBm
Input IP3 Variation Over Temperature		T _C = +25°C to -40°C		-1.8		dB
		T _C = +25°C to +85°C		+0.7		

SiGe高线性度、815MHz至1000MHz下变频器， 带有LO缓冲器/开关

MAX9986A

AC ELECTRICAL CHARACTERISTICS (continued)

(MAX9986A *Typical Application Circuit*, $V_{CC} = +4.75V$ to $+5.25V$, RF and LO ports are driven from 50Ω sources, $P_{LO} = -3dBm$ to $+3dBm$, $P_{RF} = -5dBm$, $f_{RF} = 815MHz$ to $1000MHz$, $f_{LO} = 960MHz$ to $1180MHz$, $f_{IF} = 160MHz$, $f_{LO} > f_{RF}$, $T_C = -40^\circ C$ to $+85^\circ C$, unless otherwise noted. Typical values are at $V_{CC} = +5V$, $P_{RF} = -5dBm$, $P_{LO} = 0dBm$, $f_{RF} = 910MHz$, $f_{LO} = 1070MHz$, $f_{IF} = 160MHz$, $T_C = +25^\circ C$, unless otherwise noted.) (Note 1)

PARAMETER	SYMBOL	CONDITIONS	MIN	TYP	MAX	UNITS
Noise Figure	NF	Single sideband, $f_{IF} = 190MHz$		10		dB
Noise Figure Under-Blocking		$f_{RF} = 900MHz$ (no signal) $f_{LO} = 1090MHz$ $f_{BLOCKER} = 981MHz$ $f_{IF} = 190MHz$ (Note 4)	$P_{BLOCKER} = +8dBm$	20		dB
			$P_{BLOCKER} = +11dBm$	23		
Small-Signal Compression Under-Blocking Condition		$P_{FUNDAMENTAL} = -5dBm$ $f_{FUNDAMENTAL} = 910MHz$ $f_{BLOCKER} = 911MHz$	$P_{BLOCKER} = +8dBm$	0.18		dB
			$P_{BLOCKER} = +11dBm$	0.4		
LO Drive			-3		+3	dBm
Spurious Response at IF	2 x 2	2LO - 2RF	$P_{RF} = -10dBm$	69		dBc
			$P_{RF} = -5dBm$	64		
	3 x 3	3LO - 3RF	$P_{RF} = -10dBm$	88		
			$P_{RF} = -5dBm$	78		
LO1-to-LO2 Isolation		$P_{LO} = +3dBm$ $T_C = +25^\circ C$ (Note 5)	LO2 selected	42	49	dB
			LO1 selected	42	50	
LO Leakage at RF Port		$P_{LO} = +3dBm$		-45		dBm
LO Leakage at IF Port		$P_{LO} = +3dBm$		-33		dBm
RF-to-IF Isolation				54		dB
LO Switching Time		50% of LOSEL to IF settled to within 2°		50		ns
RF Port Return Loss				20		dB
LO Port Return Loss		LO1/2 port selected, LO2/1 and IF terminated		22		dB
		LO1/2 port unselected, LO2/1 and IF terminated		34		
IF Port Return Loss		LO driven at $0dBm$, RF terminated into 50Ω , differential 200Ω		22		dB

Note 1: All limits include external component losses. Output measurements taken at IF output of the *Typical Application Circuit*.

Note 2: Operation outside this range is possible, but with degraded performance of some parameters.

Note 3: Compression point characterized. It is advisable not to operate continuously the mixer RF input above $+12dBm$.

Note 4: Measured with external LO source noise filtered so the noise floor is $-174dBm/Hz$. This specification reflects the effects of all SNR degradations in the mixer, including the LO noise as defined in *Maxim Application Note 2021*.

Note 5: Guaranteed by design and characterization.

SiGe高线性度、815MHz至1000MHz下变频器， 带有LO缓冲器/开关

MAX9986A

典型工作特性

(MAX9986A Typical Application Circuit, $V_{CC} = +5.0V$, $P_{LO} = 0dBm$, $P_{RF} = -5dBm$, $f_{LO} > f_{RF}$, $f_{IF} = 160MHz$, unless otherwise noted.)

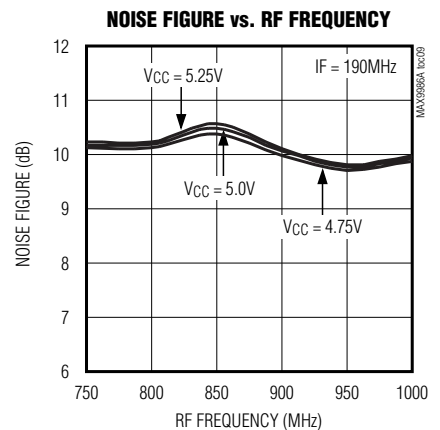
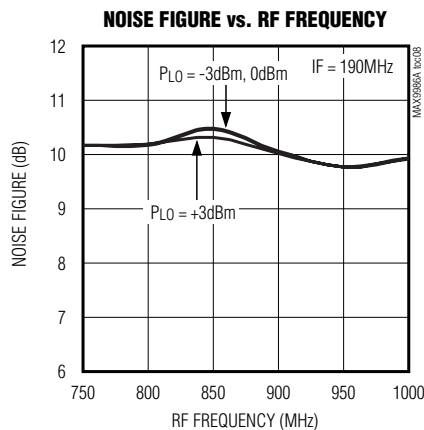
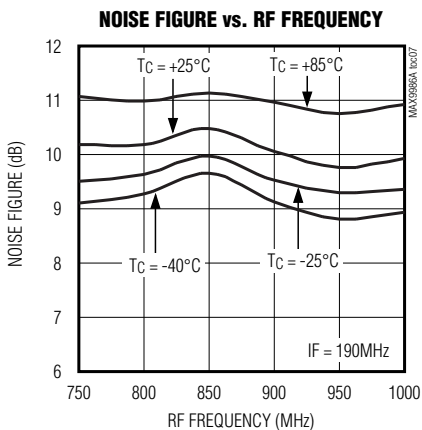
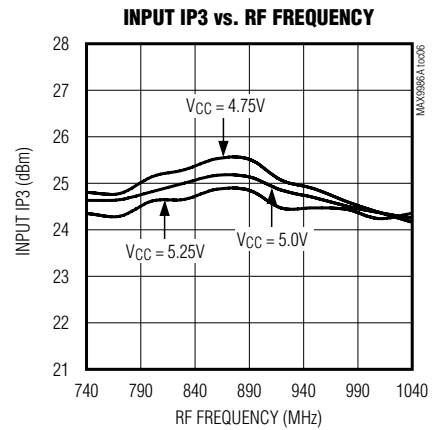
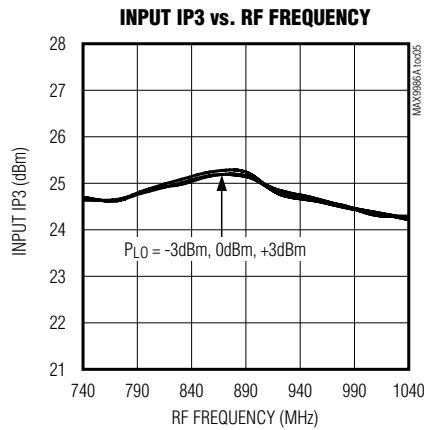
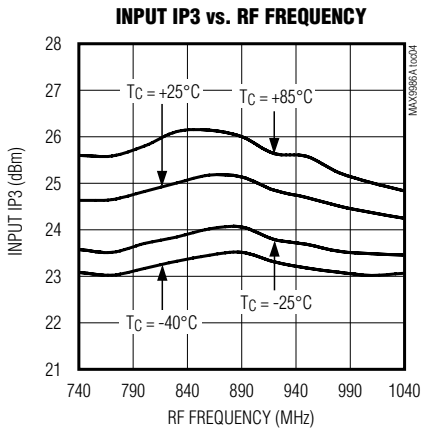
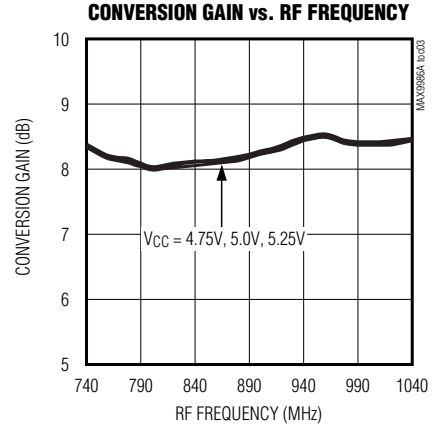
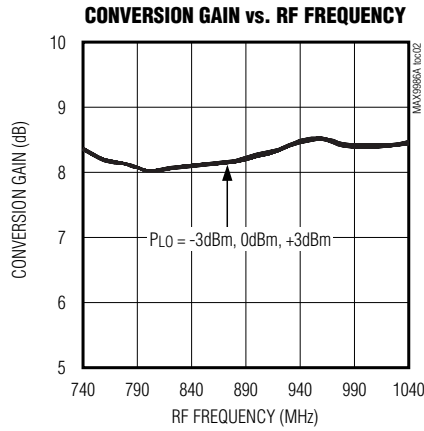
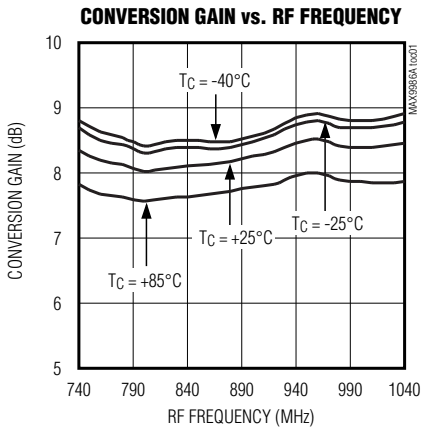

SiGe高线性度、815MHz至1000MHz下变频器， 带有LO缓冲器/开关

典型工作特性(续)

(MAX9986A Typical Application Circuit, $V_{CC} = +5.0V$, $P_{LO} = 0dBm$, $P_{RF} = -5dBm$, $f_{LO} > f_{RF}$, $f_{IF} = 160MHz$, unless otherwise noted.)

MAX9986A

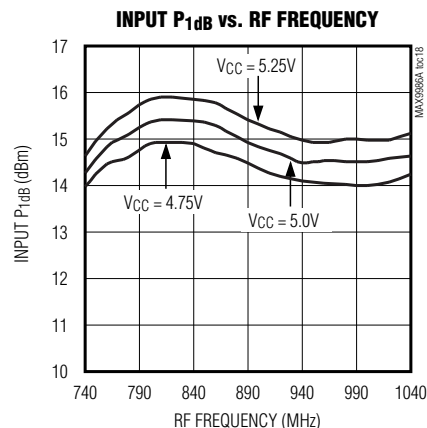
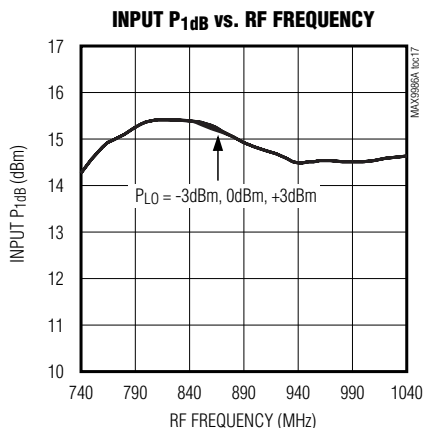
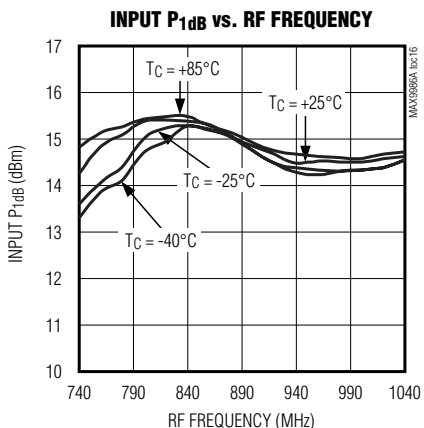
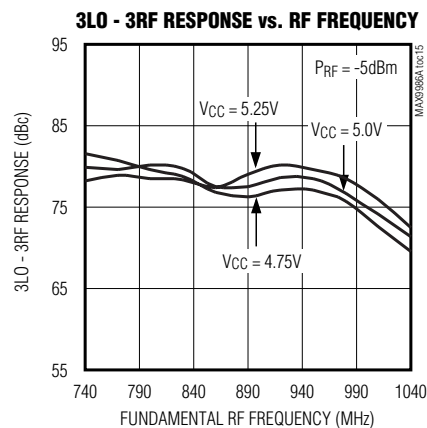
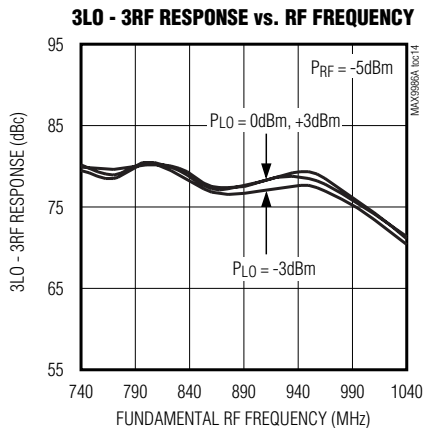
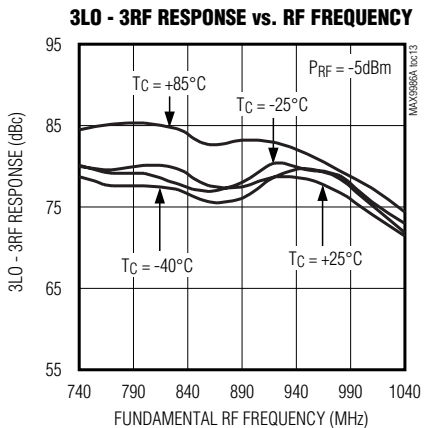
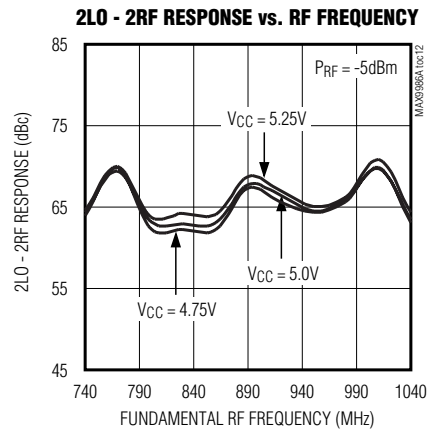
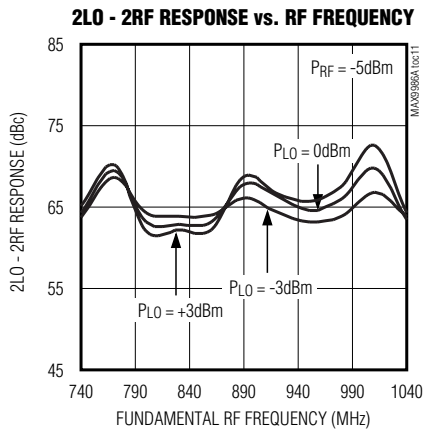
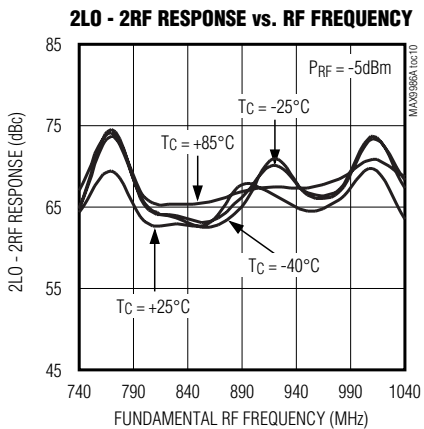

SiGe高线性度、815MHz至1000MHz下变频器， 带有LO缓冲器/开关

MAX9986A

典型工作特性(续)

(MAX9986A Typical Application Circuit, $V_{CC} = +5.0V$, $P_{LO} = 0dBm$, $P_{RF} = -5dBm$, $f_{LO} > f_{RF}$, $f_{IF} = 160MHz$, unless otherwise noted.)

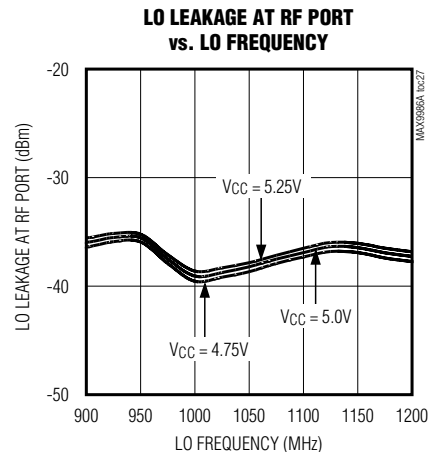
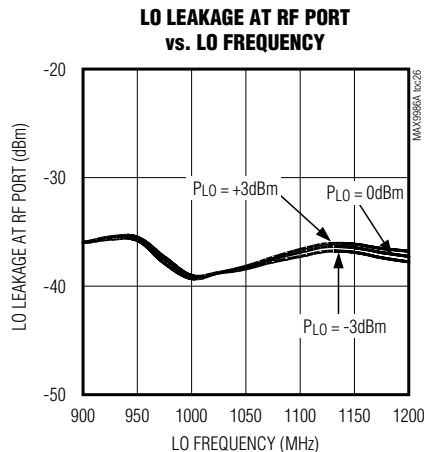
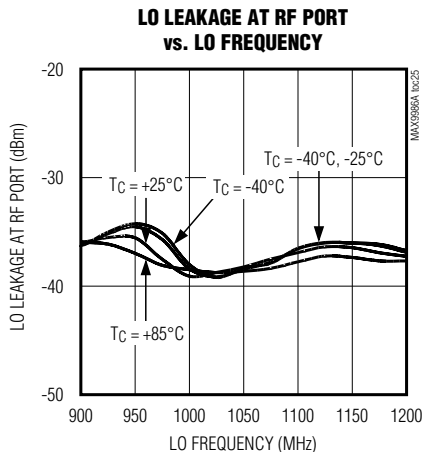
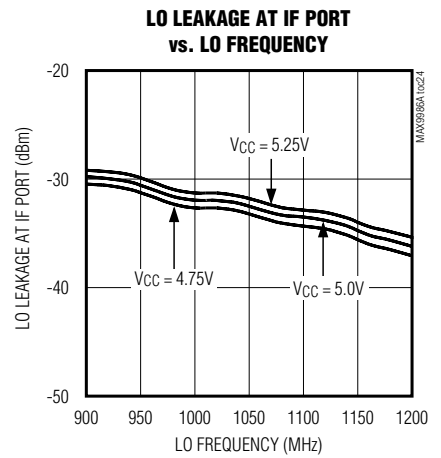
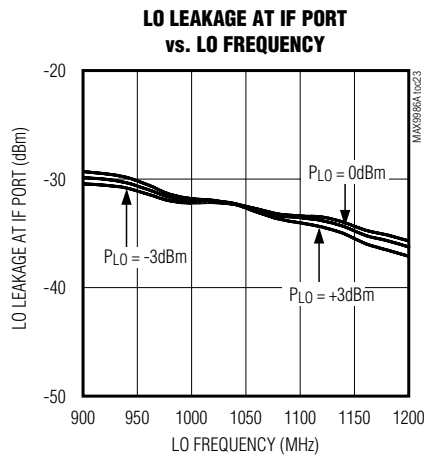
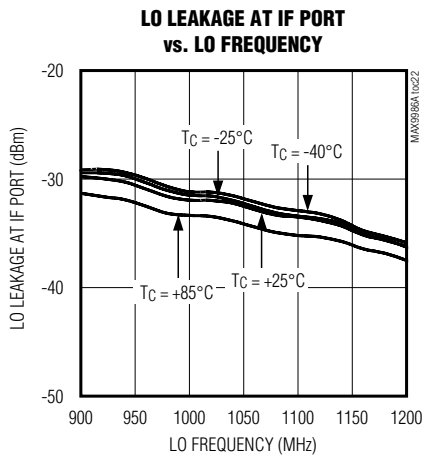
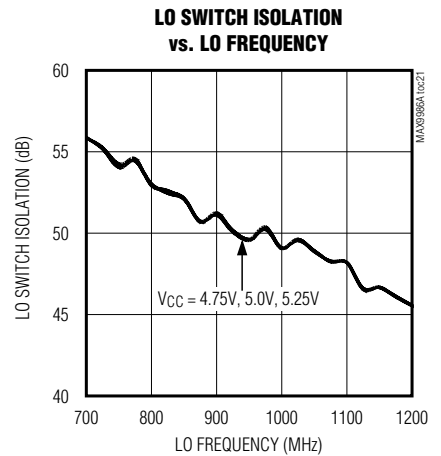
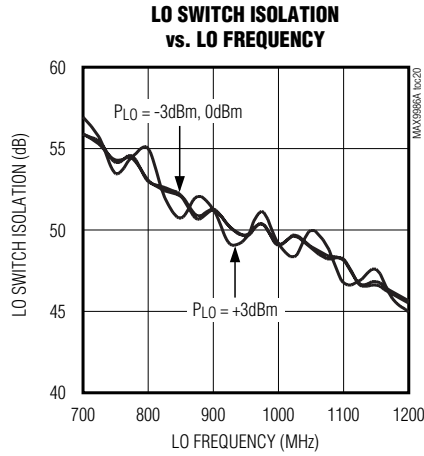
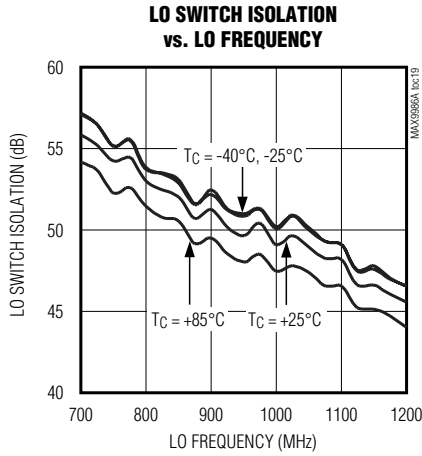

SiGe高线性度、815MHz至1000MHz下变频器， 带有LO缓冲器/开关

典型工作特性(续)

(MAX9986A Typical Application Circuit, $V_{CC} = +5.0V$, $P_{LO} = 0dBm$, $P_{RF} = -5dBm$, $f_{LO} > f_{RF}$, $f_{IF} = 160MHz$, unless otherwise noted.)

MAX9986A

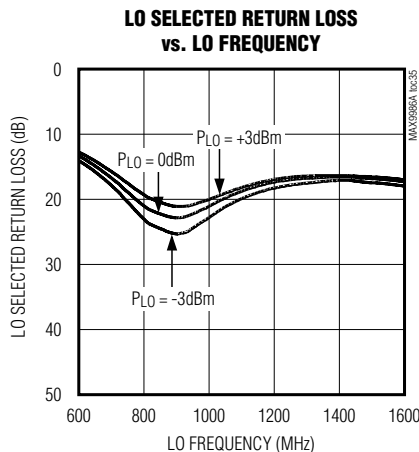
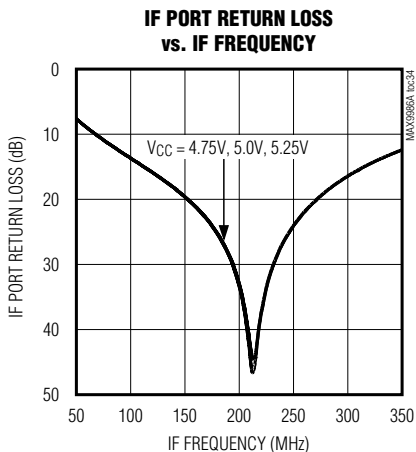
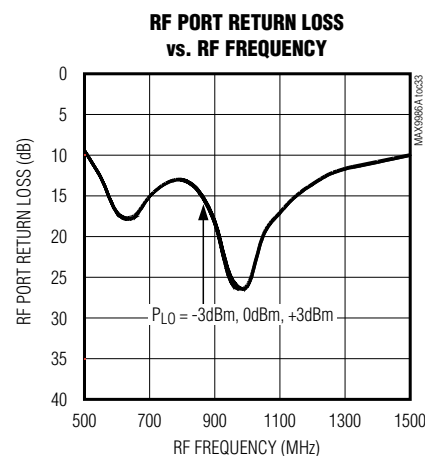
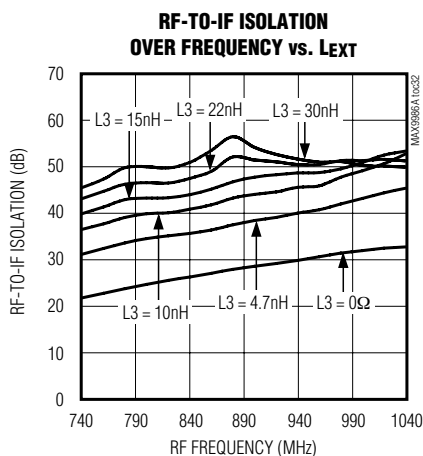
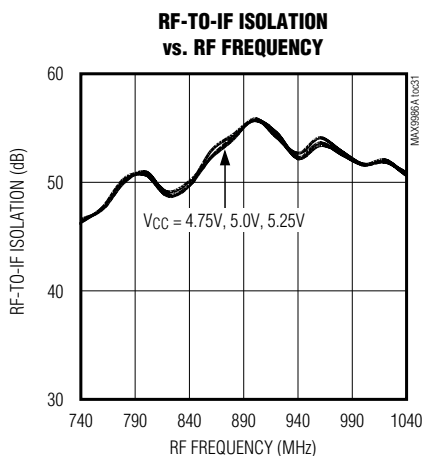
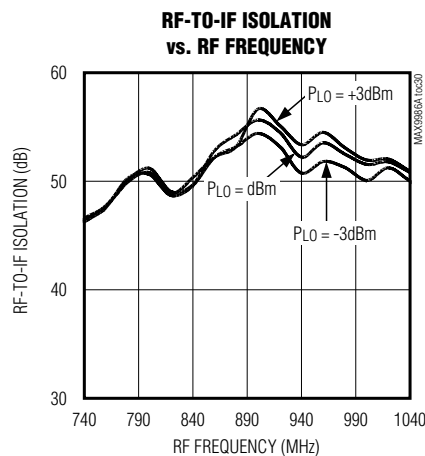
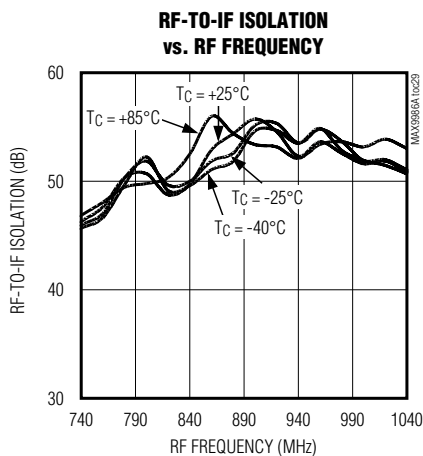
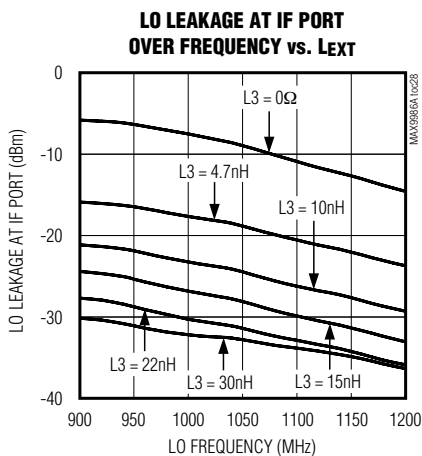

SiGe高线性度、815MHz至1000MHz下变频器， 带有LO缓冲器/开关

MAX9986A

典型工作特性(续)

(MAX9986A Typical Application Circuit, $V_{CC} = +5.0V$, $P_{LO} = 0dBm$, $P_{RF} = -5dBm$, $f_{LO} > f_{RF}$, $f_{IF} = 160MHz$, unless otherwise noted.)

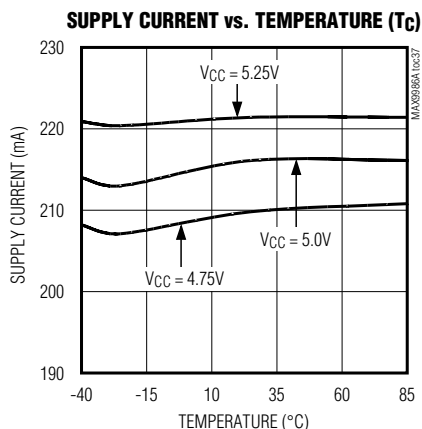
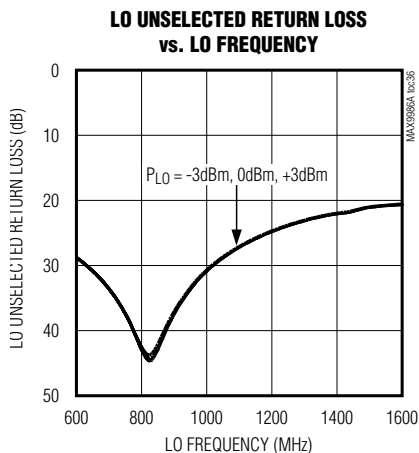

引脚说明

引脚	名称	功能
1, 6, 8, 14	VCC	电源连接端，如典型应用电路所示，将每个VCC引脚都通过电容旁路到GND。
2	RF	单端50Ω RF输入，该端口内部匹配到50Ω，并通过非平衡变压器直流短接到GND。需要一个外部隔直流电容。
3	TAP	内部RF非平衡变压器的中间抽头，如典型应用电路所示，采用靠近IC放置的电容将该引脚旁路至GND。
4, 5, 10, 12, 13, 17	GND	地。
7	LOBIAS	内部LO缓冲器的偏置电阻。LOBIAS通过一个619Ω ±1%的电阻连接到电源。
9	LOSEL	本振选择，逻辑控制输入，用于选择LO1或LO2。
11	LO1	本振输入1，LOSEL为低电平时选择LO1。
15	LO2	本振输入2，LOSEL为高电平时选择LO2。
16	LEXT	外部电感连接端。通过一个0Ω电阻将LEXT短接到地。如果需要改善RF至IF和LO至IF的隔离度，在LEXT和GND之间连接一个低ESR的电感。关于使用LEXT电感时的稳定性讨论，请参考应用信息部分。
18, 19	IF-, IF+	差分IF输出端。每个输出端均需要通过一个RF扼流圈，从外部偏置到VCC (参见典型应用电路)。
20	IFBIAS	IF放大器的偏置电阻连接端。IFBIAS与GND之间连接一个953Ω ± 1%的电阻。
EP	GND	裸露接地焊盘。通过多个过孔将裸露焊盘接到地平面。

详细说明

MAX9986A高线性度下变频混频器可提供8.2dB的变换增益、+25dBm的IIP3和典型值为10dB的噪声系数。集成非平衡变压器和匹配电路允许50Ω单端接口与RF和两个LO端口

连接。单刀双掷(SPDT)开关在两个LO输入之间提供50ns切换，LO之间具有49dB的隔离度。此外，集成LO缓冲器可以为混频器核提供较强的驱动能力，将MAX9986A输入端所需的LO驱动减小到-3dBm至+3dBm。IF端口配合差分输

SiGe高线性度、815MHz至1000MHz下变频器， 带有LO缓冲器/开关

MAX9986A

出端，有效改善了IIP2的性能。该器件可以在比较宽的频率范围内保证性能，适用于蜂窝频段GSM、cdma2000、iDEN和WCDMA 2G/2.5G/3G基站。MAX9986A规定用于815MHz至1000MHz的RF频率范围、960MHz至1180MHz的LO频率范围以及50MHz至250MHz的IF频率范围。也可应用于这些频率范围之外，请参考典型工作特性。

RF输入和非平衡变压器

MAX9986A RF输入端内部匹配到50Ω，不需要外加匹配元件。该输入端口内部通过片上非平衡变压器直流短接到地，因此需要接隔直流电容。

LO输入、缓冲器和非平衡变压器

MAX9986A具有960MHz至1180MHz的LO频率范围，适合高边LO注入应用。对于LO频率范围是570MHz至850MHz的器件，请参考MAX9984数据资料。MAX9986A还具有一个附加功能，即包括一个内部LO单刀双掷(SPDT)开关，可以实现跳频。该开关选择两个单端LO输入中的一个，在开关接通之前，可以将外部振荡器建立在一个特定频率。典型LO切换时间小于50ns，足以满足实际GSM设备的要求。如果不使用跳频功能，可以设置开关接至任意一个LO输入端。该开关由数字输入(LOSEL)控制：数字输入端为逻辑高电平时，选择LO2；为逻辑低电平时，选择LO1。为了避免损坏器件，接入数字逻辑输入LOSEL之前，V_{CC}需要先上电。LO1和LO2的输入端内部匹配到50Ω，因此只需一个82pF的隔直流电容。

内部LO缓冲器具有两级输入，允许宽输入范围的LO驱动。在-3dBm至+3dBm的LO信号功率范围内能够保证所有指标。片上低损耗非平衡变压器和LO缓冲器配合使用，驱动双平衡混频器。LO输入端与IF输出端之间的所有接口和匹配元件均已集成在芯片上。

高线性度混频器

MAX9986A的核是一个双平衡、高性能无源混频器。片上LO缓冲器提供较大的LO摆幅，因而具有出色的线性度。与集成IF放大器配合使用，级联的IIP3、2LO - 2RF抑制和NF系数典型值分别是25dBm、69dBc和10dB。

差分IF输出放大器

MAX9986A混频器的IF频率范围是50MHz至250MHz。集电极开路、差分IF输出端口需要通过外部电感上拉至V_{CC}。

注意：这些差分输出端具有较强的2LO - 2RF抑制能力，单端IF应用需要一个4:1非平衡变压器，将200Ω的差分输出阻抗转化成50Ω单端输出。

应用信息

输入和输出匹配

RF和LO输入端内部匹配到50Ω，不需要外接匹配元件。RF和LO输入端需要通过隔直流电容连接。

IF输出阻抗是200Ω(差分)。为了方便评估，用一个低损耗4:1(阻抗比)非平衡变压器将该阻抗转化成50Ω单端输出(参见典型应用电路)。

偏置电阻

LO缓冲器和IF放大器的偏置电流分别通过微调电阻R1和R2优化。如果需要以牺牲性能为代价来降低工作电流，请与厂商联系。没有±1%的偏置电阻时，也可以选用±5%的标准电阻。

LEXT电感

用一个0Ω电阻将LEXT与地短接。需要改善RF至IF、LO至IF的隔离度时，在LEXT和GND之间连接一个低ESR电感。使用不同电感时，RF至IF的隔离度和LO至IF的泄漏指标请参考典型工作特性。混频器的负载阻抗必须保证IF-、IF+与地之间的电容为不会超出几个皮法(PF)，只有这样器件才能稳定工作。

由于流过LEXT的电流大约为140mA，因此需要选择一个低DCR的绕线电感。

布局考虑

合理的PC板布局对于RF/微波电路来说非常重要。RF信号线应尽可能短，以减小损耗、辐射和电感。为了获得最佳性能，接地引脚须直接与封装底部的裸焊盘连接。PC板的裸焊盘必须连接至PC板的地层。建议采用多个过孔将裸焊盘连接至地层。这种方法能为器件提供了一个良好的RF/散热路径。将器件封装底部的裸焊盘焊接至PC板上。电路板布局可以参考MAX9986A评估板，Gerber文件可从www.maxim-ic.com.cn申请。

SiGe高线性度、815MHz至1000MHz下变频器， 带有LO缓冲器/开关

MAX9986A

电源旁路

合理的电源旁路对高频电路的稳定性至关重要。如典型应用电路所示，用电容旁路每一个V_{CC}引脚和TAP引脚，参见表1。将TAP的对地旁路电容放置在距离TAP引脚100mil以内的位置。

裸焊盘的RF/散热考虑

MAX9986A采用20引脚薄型QFN-EP封装，其裸焊盘(EP)提供了一个与管芯之间的低热阻通路。设计PC板时，借助MAX9986A的裸焊盘散热非常重要。此外，裸焊盘应通过一个低电感路径接地。裸焊盘必须直接或通过一系列电镀过孔焊接至PC板的地平面。

表1. 典型应用电路的元件列表

COMPONENT	VALUE	DESCRIPTION
L1, L2	330nH	Wire-wound high-Q inductors (0805)
L3*	30nH	Wire-wound high-Q inductor (0603)
C1	10pF	Microwave capacitor (0603)
C2, C4, C7, C8, C10, C11, C12	82pF	Microwave capacitors (0603)
C3, C5, C6, C9, C13, C14	0.01μF	Microwave capacitors (0603)
C15	220pF	Microwave capacitor (0402)
R1	953Ω	±1% resistor (0603)
R2	619Ω	±1% resistor (0603)
R3	0Ω	±1% resistor (1206)
T1	4:1 balun	IF balun TC4-1W-7A
U1	MAX9986A	Maxim IC

*利用L3改善RF至IF、LO至IF的隔离度。参见应用信息中关于使用L3电感时的稳定性讨论。

引脚配置/功能框图

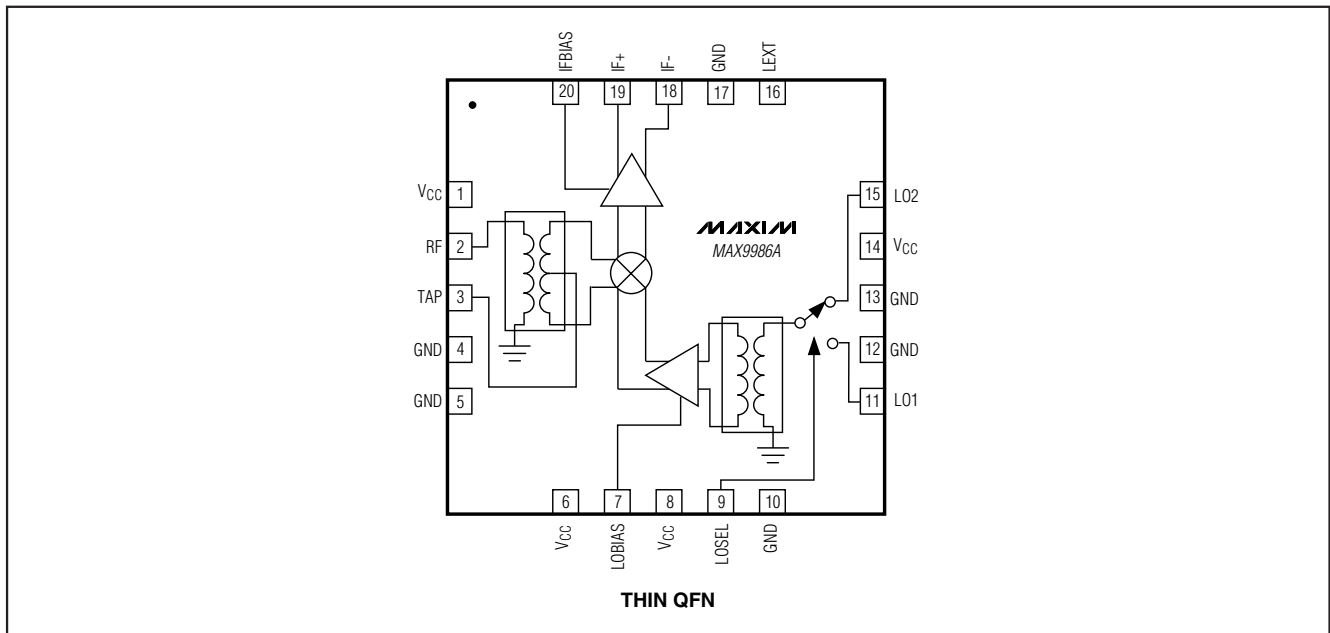

SiGe高线性度、815MHz至1000MHz下变频器， 带有LO缓冲器/开关

典型应用电路

MAX9986A

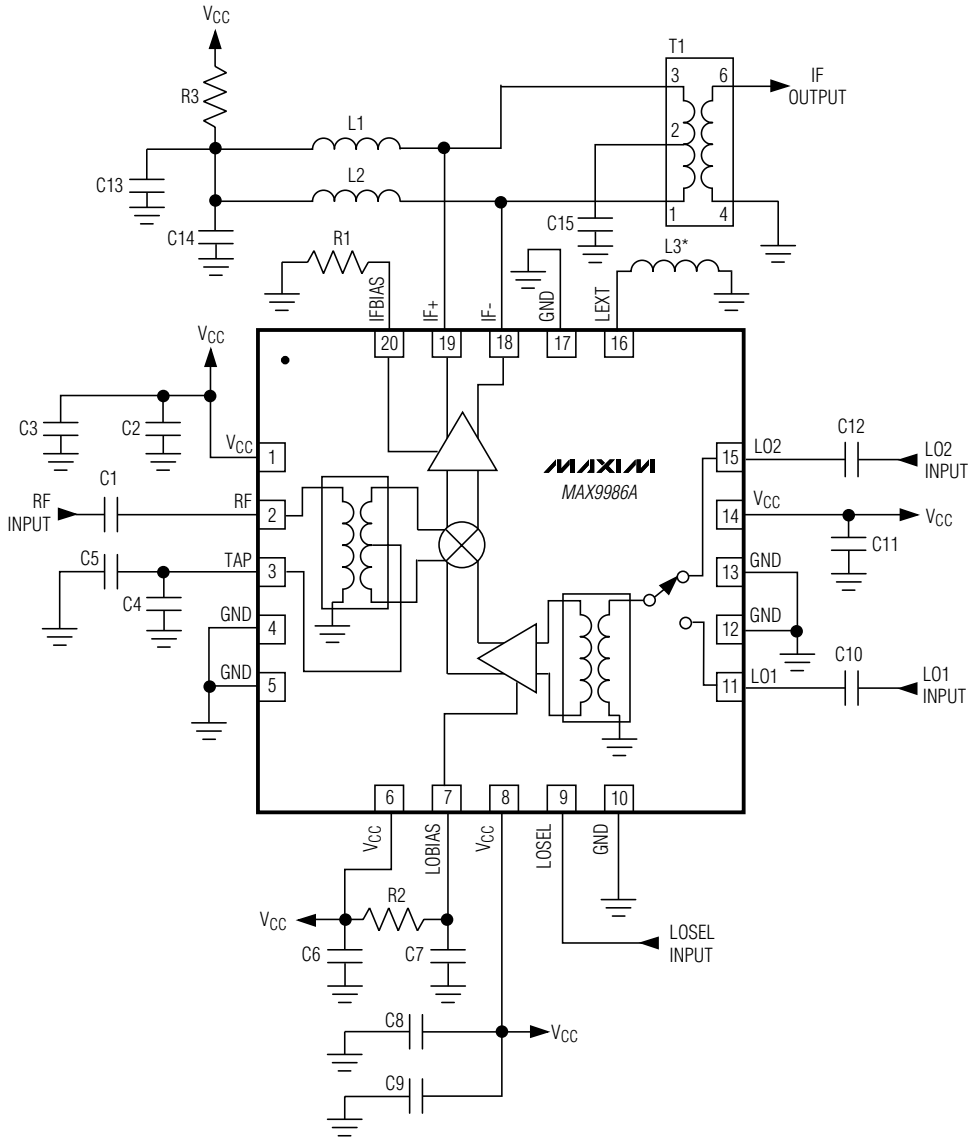

*USE L3 FOR IMPROVED RF-TO-IF AND LO-TO-IF ISOLATION. SEE THE *Applications Information* SECTION REGARDING STABILITY ISSUES WHEN USING L3 INDUCTOR.

芯片信息

TRANSISTOR COUNT: 1017

PROCESS: SiGe BiCMOS

SiGe 高线性度、815MHz 至 1000MHz 下变频器， 带有 LO 缓冲器/开关

MAX9986A

封装信息

(本数据资料提供的封装图可能不是最近的规格，如需最近的封装外型信息，请查询 www.maxim-ic.com.cn/packages.)

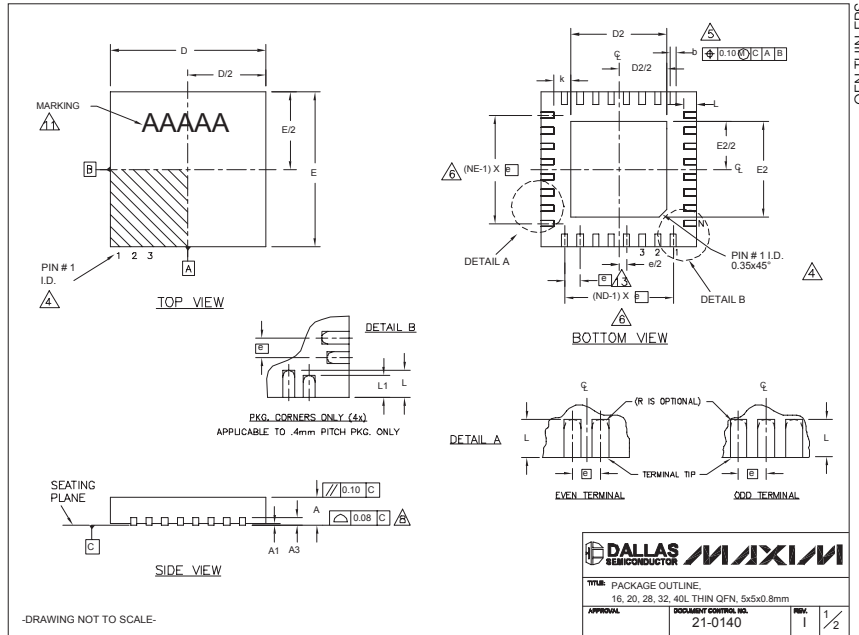

COMMON DIMENSIONS															
PKG. SYMBOL	16L 5x5			20L 5x5			28L 5x5			32L 5x5			40L 5x5		
	MIN.	NOM.	MAX.	MIN.	NOM.	MAX.	MIN.	NOM.	MAX.	MIN.	NOM.	MAX.	MIN.	NOM.	MAX.
A	0.70	0.75	0.80	0.70	0.75	0.80	0.70	0.75	0.80	0.70	0.75	0.80	0.70	0.75	0.80
A1	0	0.02	0.05	0	0.02	0.05	0	0.02	0.05	0	0.02	0.05	0	0.02	0.05
A3	0.20 REF.			0.20 REF.			0.20 REF.			0.20 REF.			0.20 REF.		
b	0.25	0.30	0.35	0.25	0.30	0.35	0.20	0.25	0.30	0.20	0.25	0.30	0.15	0.20	0.25
D	4.90	5.00	5.10	4.90	5.00	5.10	4.90	5.00	5.10	4.90	5.00	5.10	4.90	5.00	5.10
E	4.90	5.00	5.10	4.90	5.00	5.10	4.90	5.00	5.10	4.90	5.00	5.10	4.90	5.00	5.10
e	0.80 BSC.			0.65 BSC.			0.50 BSC.			0.50 BSC.			0.40 BSC.		
k	0.25	-	-	0.25	-	-	0.25	-	-	0.25	-	-	0.25	0.35	0.45
L	0.30	0.40	0.50	0.45	0.55	0.65	0.45	0.55	0.65	0.30	0.40	0.50	0.40	0.50	0.60
L1	-	-	-	-	-	-	-	-	-	-	-	-	0.30	0.40	0.50
N	16			20			28			32			40		
ND	4			5			7			8			10		
NE	4			5			7			8			10		
JEDEC	WHHB			WHHC			WHHD-1			WHHD-2			----		

PKG. CODES	D2			E2			L	DOWN BONDS ALLOWED
	MIN.	NOM.	MAX.	MIN.	NOM.	MAX.		
T1655-2	3.00	3.10	3.20	3.00	3.10	3.20	**	YES
T1655-3	3.00	3.10	3.20	3.00	3.10	3.20	**	NO
T1655N-1	3.00	3.10	3.20	3.00	3.10	3.20	**	NO
T2055-3	3.00	3.10	3.20	3.00	3.10	3.20	**	YES
T2055-4	3.00	3.10	3.20	3.00	3.10	3.20	**	NO
T2055-5	3.15	3.25	3.35	3.15	3.25	3.35	0.40	YES
T2855-3	3.15	3.25	3.35	3.15	3.25	3.35	**	YES
T2855-4	2.60	2.70	2.80	2.60	2.70	2.80	**	YES
T2855-5	2.60	2.70	2.80	2.60	2.70	2.80	**	NO
T2855-6	3.15	3.25	3.35	3.15	3.25	3.35	**	NO
T2855-7	2.60	2.70	2.80	2.60	2.70	2.80	**	YES
T2855-8	3.15	3.25	3.35	3.15	3.25	3.35	0.40	YES
T2855N-1	3.15	3.25	3.35	3.15	3.25	3.35	**	NO
T3255-3	3.00	3.10	3.20	3.00	3.10	3.20	**	YES
T3255-4	3.00	3.10	3.20	3.00	3.10	3.20	**	NO
T3255-5	3.00	3.10	3.20	3.00	3.10	3.20	**	YES
T3255N-1	3.00	3.10	3.20	3.00	3.10	3.20	**	NO
T4055-1	3.20	3.30	3.40	3.20	3.30	3.40	**	YES

NOTES:
 1. DIMENSIONING & TOLERANCING CONFORM TO ASME Y14.5M-1994.
 2. ALL DIMENSIONS ARE IN MILLIMETERS. ANGLES ARE IN DEGREES.
 3. N IS THE TOTAL NUMBER OF TERMINALS.
 4. THE TERMINAL #1 IDENTIFIER AND TERMINAL NUMBERING CONVENTION SHALL CONFORM TO JEDEC 95-1 SPP-012. DETAILS OF TERMINAL #1 IDENTIFIER ARE OPTIONAL, BUT MUST BE LOCATED WITHIN THE ZONE INDICATED. THE TERMINAL #1 IDENTIFIER MAY BE EITHER A MOLD OR MARKED FEATURE.
 5. DIMENSION b APPLIES TO METALLIZED TERMINAL AND IS MEASURED BETWEEN 0.25 mm AND 0.30 mm FROM TERMINAL TIP.
 6. ND AND NE REFER TO THE NUMBER OF TERMINALS ON EACH D AND E SIDE RESPECTIVELY.
 7. DEPOPULATION IS POSSIBLE IN A SYMMETRICAL FASHION.
 8. COPLANARITY APPLIES TO THE EXPOSED HEAT SINK SLUG AS WELL AS THE TERMINALS.
 9. DRAWING CONFORMS TO JEDEC MO220, EXCEPT EXPOSED PAD DIMENSION FOR T2855-3 AND T2855-6.
 10. WARPAGE SHALL NOT EXCEED 0.10 mm.
 11. MARKING IS FOR PACKAGE ORIENTATION REFERENCE ONLY.
 12. NUMBER OF LEADS SHOWN ARE FOR REFERENCE ONLY.
 13. LEAD CENTERLINES TO BE AT TRUE POSITION AS DEFINED BY BASIC DIMENSION "e", ±0.05.

MAX9986A package outline drawing showing top, bottom, and side views with dimensions and callouts. The drawing includes a top view with dimensions D, D/2, E, E/2, and a marking area labeled 'AAAAA'. The bottom view shows terminal locations with dimensions D2, D2/2, b, c, E2, and callouts for (NE-1) X, (ND-1) X, and PIN # 1 I.D. 0.35x45°. A side view shows the seating plane and dimensions A1, A3, and A. Details A and B show terminal profiles. A note indicates 'PKG. CORNERS ONLY (4x) APPLICABLE TO .4mm PITCH PKG. ONLY'. A title block contains the Dallas Semiconductor logo, 'MAXIM', 'TITLE PACKAGE OUTLINE', '16, 20, 28, 32, 40L THIN QFN, 5x5x0.8mm', 'APPROVAL', 'DOCUMENT CONTROL NO. 21-0140', 'REV. 1', and '1/2'.

Maxim 不对 Maxim 产品以外的任何电路使用负责，也不提供其专利许可。Maxim 保留在任何时间、没有任何通报的前提下修改产品资料和规格的权利。

12 **Maxim Integrated Products, 120 San Gabriel Drive, Sunnyvale, CA 94086 (408) 737-7600**

© 2006 Maxim Integrated Products

Printed USA

MAXIM 是 Maxim Integrated Products, Inc. 的注册商标。