

**2N3878, 2N3879, 2N5202, 2N6500**

File Number **766**

**High-Speed, Epitaxial-Collector  
Silicon N-P-N Planar Transistors**

For High-Speed Switching and Linear-Amplifier Applications

**Features:**

- Maximum-area-of-operation curves for dc and pulse operation
- High sustaining voltage
- Total saturated transition time less than 1  $\mu$ s for 2N3879, 2N5202, and 2N6500

RCA-2N3878, 2N3879, 2N5202, and 2N6500\* are epitaxial silicon n-p-n transistors. The 2N3878 is an amplifier type intended for audio-, ultrasonic-, and radio-frequency circuits. Types 2N3879, 2N5202, and 2N6500 are switching transistors intended for use in high-current, high-speed switching circuits.

Typical applications for these transistors include: low-distortion power amplifiers, oscillators, switching regulators, series regulators, converters, and inverters.

\*Formerly RCA Dev. Type Nos. TA2509, TA2509A, TA7285, and TA8932, respectively.

**TERMINAL DESIGNATIONS**

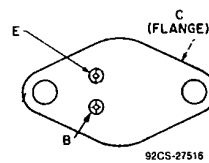

**JEDEC TO-213AA**

**MAXIMUM RATINGS, Absolute-Maximum Values:**

	2N3878	2N3879	2N5202	2N6500		
*COLLECTOR-TO-BASE VOLTAGE . . . . .	$V_{CB0}$	120	120	100	120	V
COLLECTOR-TO-EMITTER SUSTAINING VOLTAGE:						
With external base-to-emitter resistance ( $R_{BE}$ ) = 50 $\Omega$ .	$V_{CER(sus)}$	65	90	75*	110*	V
With base open. . . . .	$V_{CEO(sus)}$	50*	75*	50	90*	V
*EMITTER-TO-BASE VOLTAGE . . . . .	$V_{EBO}$	7	7	6	7	V
*CONTINUOUS COLLECTOR CURRENT . . . . .	$I_C$	4	7	4	4	A
PEAK COLLECTOR CURRENT . . . . .	$I_{CM}$	10	10	5	5	A
*CONTINUOUS BASE CURRENT . . . . .	$I_B$	4	5	2	3	A
*TRANSISTOR DISSIPATION . . . . .	$P_T$					W
At case temperature ( $T_C$ ) = 25°C . . . . .		35	35	35	35	
At case temperatures above 25°C . . . . .		Derate linearly at 0.2 W/°C				
For other conditions . . . . .		See Figs. 1, 3 and 4				
*TEMPERATURE RANGE:						°C
Storage & operating (Junction) . . . . .			-65 to 200			
*PIN TEMPERATURE:						°C
1/32 in. (0.8 mm) from seating plane for 10 s max. . . . .		235	235	235	235	

\* In accordance with JEDEC registration data format JS-6 RDF-2 (2N3878); JS-6 RDF-1 (2N3879, 2N5202, 2N6500).

2N3878, 2N3879, 2N5202, 2N6500

ELECTRICAL CHARACTERISTICS, At Case Temperature ( $T_C$ ) = 25°C unless otherwise specified:

CHARACTERISTIC	SYMBOL	TEST CONDITIONS				LIMITS								UNITS
		VOLTAGE V dc		CURRENT A dc		2N3878		2N3879		2N5202		2N6500		
		V <sub>CE</sub>	V <sub>BE</sub>	I <sub>C</sub>	I <sub>B</sub>	Min.	Max.	Min.	Max.	Min.	Max.	Min.	Max.	
* Collector Cutoff Current: With base-emitter junction reverse-biased	I <sub>CEV</sub>	100	-1.5			-	-	-	-	-	10	-	-	mA
		110	0			-	25	-	25	-	-	-	5	
* With base-emitter junction reverse-biased and $T_C = 150^\circ\text{C}$	I <sub>CEV</sub>	100	-1.5			-	4	-	4	-	10	-	-	10
With base open	I <sub>CEO</sub>	40			0	-	5*	-	5	-	-	-	-	5
		70			0	-	-	-	-	-	-	-	-	5
* Emitter Cutoff Current	I <sub>EBO</sub>		-6			-	10	-	10	-	10	-	-	25
Collector-to-Emitter Sustaining Voltage With base open	V <sub>CEO(sus)</sub>			0.2	0	50 <sup>a</sup>	-	75 <sup>a</sup>	-	50 <sup>a</sup>	-	90 <sup>a</sup>	-	V
With external base-to-emitter resistance ( $R_{BE}$ ) = 50 $\Omega$	V <sub>CER(sus)</sub>			0.2	0	65 <sup>a</sup>	-	90 <sup>a</sup>	-	75 <sup>a</sup>	-	110 <sup>a</sup>	-	V
DC Forward-Current Transfer Ratio	h <sub>FE</sub>	1.2		4 <sup>b</sup>		-	-	-	-	10*	100*	-	-	
		2		0.5 <sup>b</sup>		40*	200*	-	-	-	-	-	-	-
		2		3 <sup>b</sup>		-	-	-	-	-	-	-	15*	60*
		2		4 <sup>b</sup>		8*	-	12*	100*	-	-	-	-	-
		5		4 <sup>b</sup>		20*	-	20	80	-	-	-	-	-
		5		0.5 <sup>b</sup>		50*	200*	40	-	-	-	-	-	-
* Collector-to-Emitter Saturation Voltage	V <sub>CE(sat)</sub>			3 <sup>b</sup> 4 <sup>b</sup>	0.3 0.4	-	2	-	1.2	-	1.2	-	-	1.5
* Base-to-Emitter Voltage	V <sub>BE</sub>	2		4 <sup>b</sup>	-	-	2.5	-	-	-	-	-	-	V
* Base-to-Emitter Saturation Voltage	V <sub>BE(sat)</sub>			3 <sup>b</sup> 4 <sup>b</sup>	0.3 0.4	-	-	-	2	-	2	-	-	2.5
Collector-to-Base Output Capacitance (f = 1 MHz, V <sub>CB</sub> = 10 V)	C <sub>ob</sub>					-	175*	-	175	-	175	-	175	pF
Second Breakdown Collector Current With base forward-biased and 1-s nonrepetitive pulse	I <sub>S/b</sub>	40				750	-	500	-	400	-	400	-	mA
* Magnitude of Common Emitter, Small-Signal, Short-Circuit, Forward-Current Transfer Ratio (f = 10 MHz)	h <sub>fe</sub>	10		0.5		4	-	4	-	6	-	6	-	
* Common-Emitter, Small-Signal, Short-Circuit, Forward-Current Transfer Ratio (f = 1 kHz)	h <sub>fe</sub>	30		0.1		40	-	-	-	-	-	-	-	
Thermal Resistance Junction-to-case	R <sub>θJC</sub>					-	5	-	5	-	5	-	5	°C/W

\* In accordance with JEDEC registration data format JS-6 RDF-2 (2N3878); JS-6 RDF-1 (2N3879, 2N5202, 2N6500).

<sup>a</sup> CAUTION: Sustaining voltages V<sub>CEO(sus)</sub> and V<sub>CER(sus)</sub> MUST NOT be measured on a curve tracer.

<sup>b</sup> Pulsed, pulse duration = 300  $\mu\text{s}$ , duty factor  $\leq 2\%$ .

2N3878, 2N3879, 2N5202, 2N6500

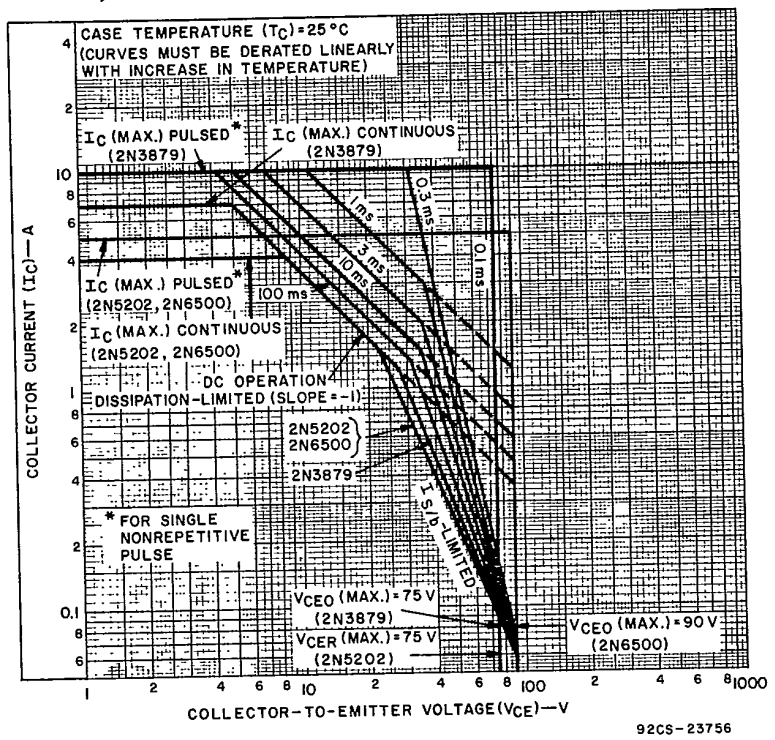

Fig. 1 - Maximum operating areas for 2N3879, 2N5202, and 2N6500.

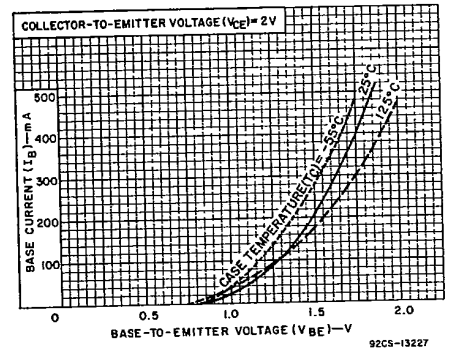

Fig. 2 - Typical input characteristics for all types.

2N3878, 2N3879, 2N5202, 2N6500

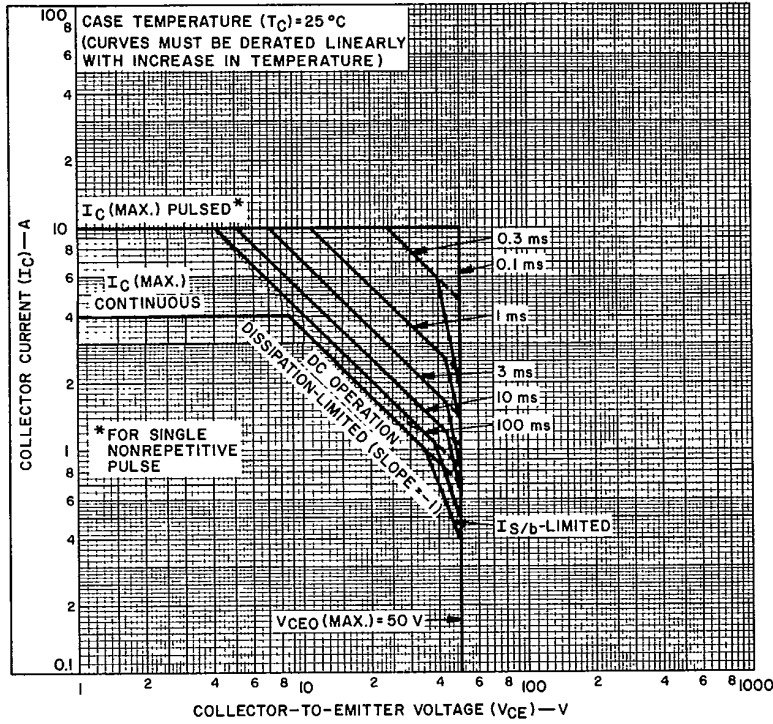

Fig. 3 - Maximum operating areas for 2N3878.

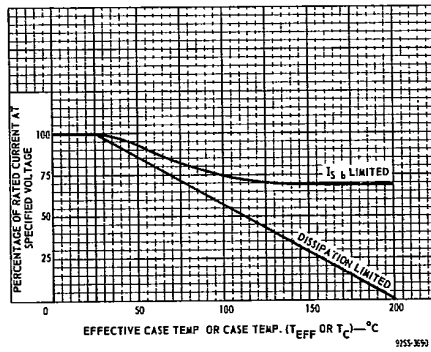

Fig. 4 - Dissipation derating for all types.

2N3878, 2N3879, 2N5202, 2N6500

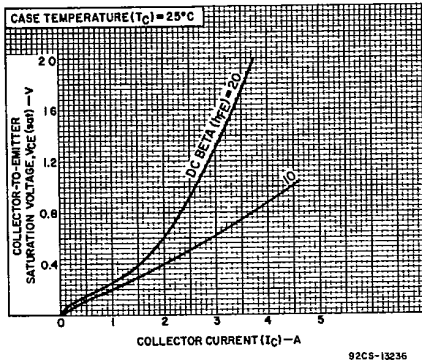

Fig. 5 - Typical saturation-voltage characteristics for 2N3878, and 2N3879.

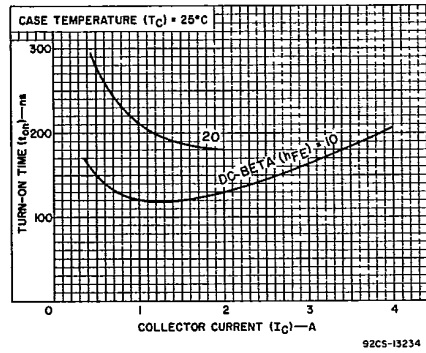

Fig. 6 - Typical turn-on time for 2N3879, 2N5202, and 2N6500.

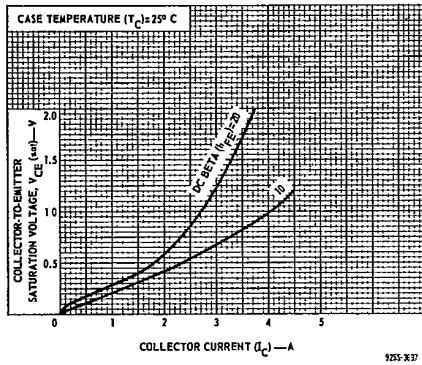

Fig. 7 - Typical saturation-voltage characteristics for 2N5202.

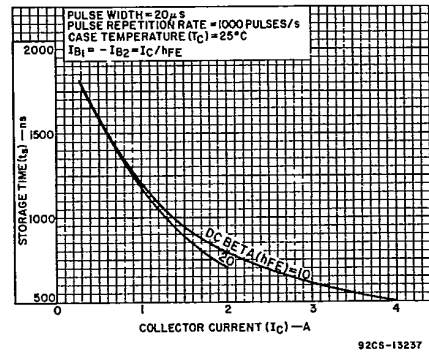

Fig. 8 - Typical storage time for 2N3879, 2N5202, and 2N6500.

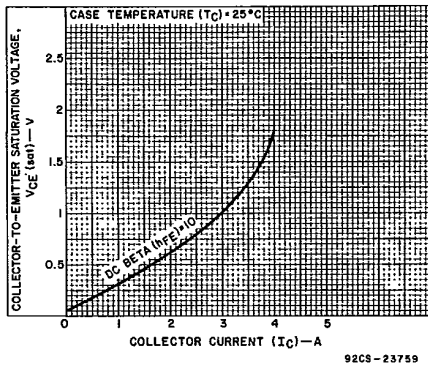

Fig. 9 - Typical saturation-voltage characteristics for 2N6500.

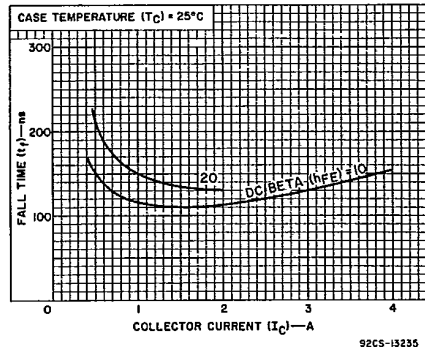

Fig. 10 - Typical fall time for 2N3879, 2N5202, and 2N6500.

2N3878, 2N3879, 2N5202, 2N6500

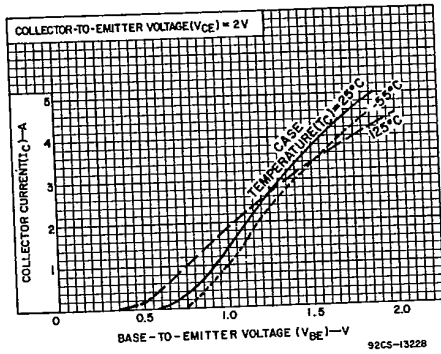

Fig. 11 - Typical transfer characteristics for all types.

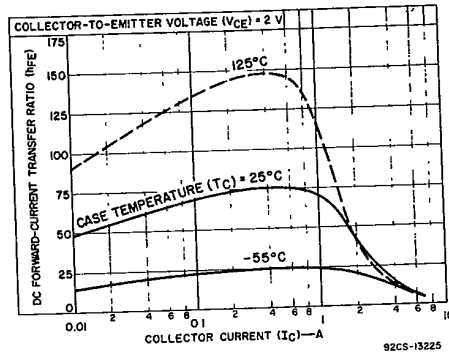

Fig. 12 - Typical dc beta characteristics for 2N3878 and 2N3879.

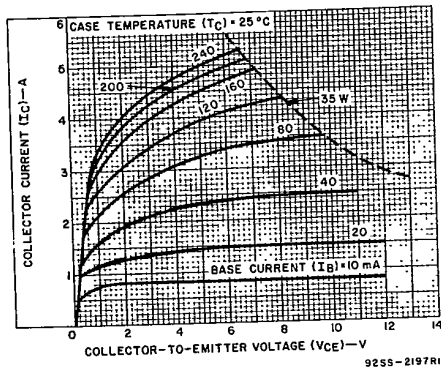

Fig. 13 - Typical output characteristics for 2N3878, 2N3879 and 2N5202.

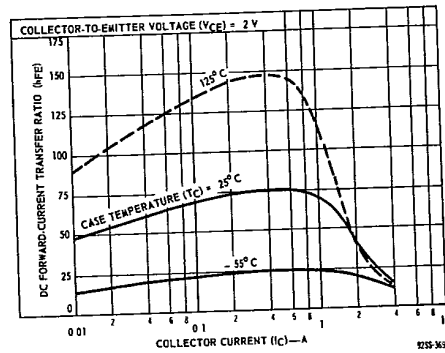

Fig. 14 - Typical dc beta characteristics for 2N5202.

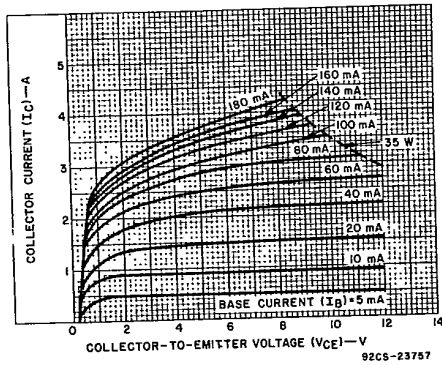

Fig. 15 - Typical output characteristics for 2N6500.

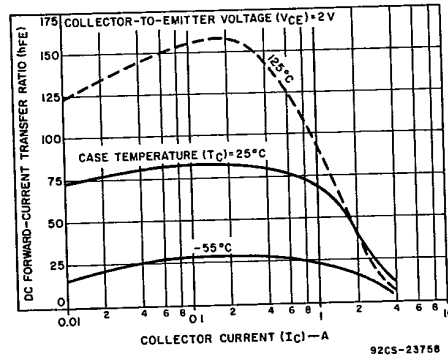

Fig. 16 - Typical dc beta characteristics for 2N6500.

**2N3878, 2N3879, 2N5202, 2N6500**

TRANSITION AND STORAGE-TIME CHARACTERISTICS FOR SWITCHING TYPES, At Case Temperature ( $T_C$ ) = 25°C:

CHARACTERISTIC	SYMBOL	TEST CONDITIONS			LIMITS						UNITS
		VOLTAGE V dc		CURRENT A dc	2N3879		2N5202		2N6500		
		VCC	I <sub>C</sub>	I <sub>B</sub>	Min.	Max.	Min.	Max.	Min.	Max.	
Saturated Switching Time	t <sub>d</sub>	30	3	0.3 <sup>a</sup>	-	-	-	-	-	40	ns
		30	4	0.4 <sup>a</sup>	-	40	-	-	-	-	
		30	4	0.8 <sup>a</sup>	-	-	-	40	-	-	
Delay time	t <sub>r</sub>	30	3	0.3 <sup>a</sup>	-	-	-	-	-	400	
		30	4	0.4 <sup>a</sup>	-	400	-	-	-	-	
Rise time	t <sub>s</sub>	30	3	0.3 <sup>a</sup>	-	-	-	-	-	1000	
		30	4	0.4 <sup>a</sup>	-	800	-	-	-	-	
Storage time	t <sub>f</sub>	30	3	0.3 <sup>a</sup>	-	-	-	-	-	500	
		30	4	0.4 <sup>a</sup>	-	400	-	-	-	-	
Fall time	t <sub>f</sub>	30	3	0.3 <sup>a</sup>	-	-	-	-	-	-	
		30	4	0.8 <sup>a</sup>	-	-	-	400	-	-	

\* In accordance with JEDEC registration data format (JS-6, RDF-1)

<sup>a</sup> I<sub>B1</sub> = I<sub>B2</sub>

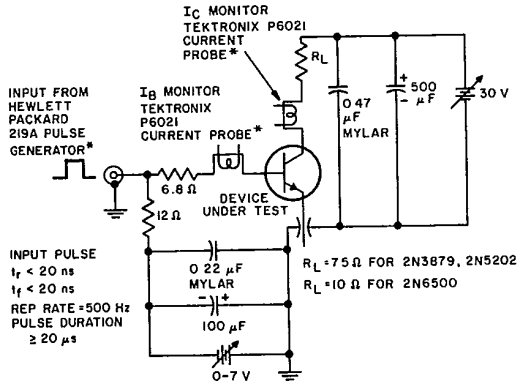

\*OR EQUIVALENT

92CS-23754

Fig. 17 - Circuit used to measure switching times for 2N3879, 2N5202, and 2N6500.

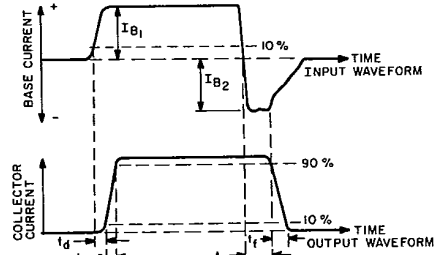

92CS-23760

Fig. 18 - Oscilloscope display for measurement of switching times. (Circuit shown in Fig. 17).

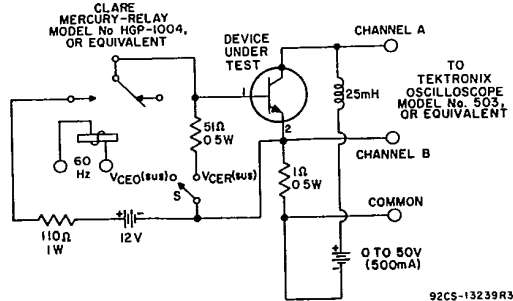

92CS-13239R3

Fig. 19 - Circuit used to measure sustaining voltages, V<sub>CE0</sub>(sus) and V<sub>CER</sub>(sus) for all types.

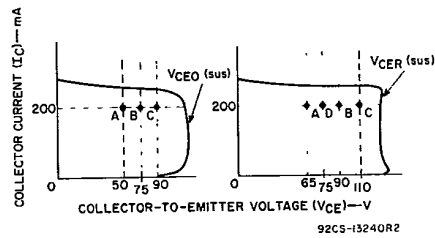

92CS-13240R2

The sustaining voltages V<sub>CE0</sub>(sus) and V<sub>CER</sub>(sus) are acceptable when the traces fall to the right and above point "A" for types 2N3878, 40375, and 2N5202; point "B" for type 2N3879; and point "C" for type 2N6500. The sustaining voltage V<sub>CER</sub>(sus) is acceptable when the trace falls to the right and above point "D" for type 2N5202.

Fig. 20 - Oscilloscope display for measurement of sustaining voltages.