

SPECIFICATION

Device Name : IGBT Module

Type Name : 7MBR25SA120-01

Spec. No. : MS6M 0547

Date : Jun. - 02 - 2000

This material and the information herein is the property of Fuji Electric Co., Ltd. They shall be neither reproduced, copied, lent, or disclosed in any way whatsoever for the use of any third party, nor used for the manufacturing purposes without the express written consent of Fuji Electric Co., Ltd.

Fuji Electric Co., Ltd.
Matsumoto Factory

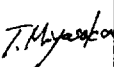
	DATE	NAME	APPROVED	Fuji Electric Co., Ltd.			
DRAWN	Jun. - 2 - '00	J. Kobayashi		DWG. NO.	MS6M 0547	1 / 10	
CHECKED	June - 2 - 00	D. Nishida					a

Revised Records

Date	Classi- fication	Ind.	Content	Applied date	Drawn	Checked	Approved
Jun.-2-'60	enactment	—	—————	Issued date	—	S. Nitta	T. Miyasaka
Jun-14-'60	Revision	a	Revised type miss (PS/10)		G. Kobayashi	S. Nitta	T. Miyasaka

This material and the information herein is the property of Fuji Electric Co. Ltd. They shall be neither reproduced, copied, lent, or disclosed in any way whatsoever for the use of any third party, nor used for the manufacturing purposes without the express written consent of Fuji Electric Co., Ltd.

7MBR25SA120-01

1. Outline Drawing (Unit : mm)

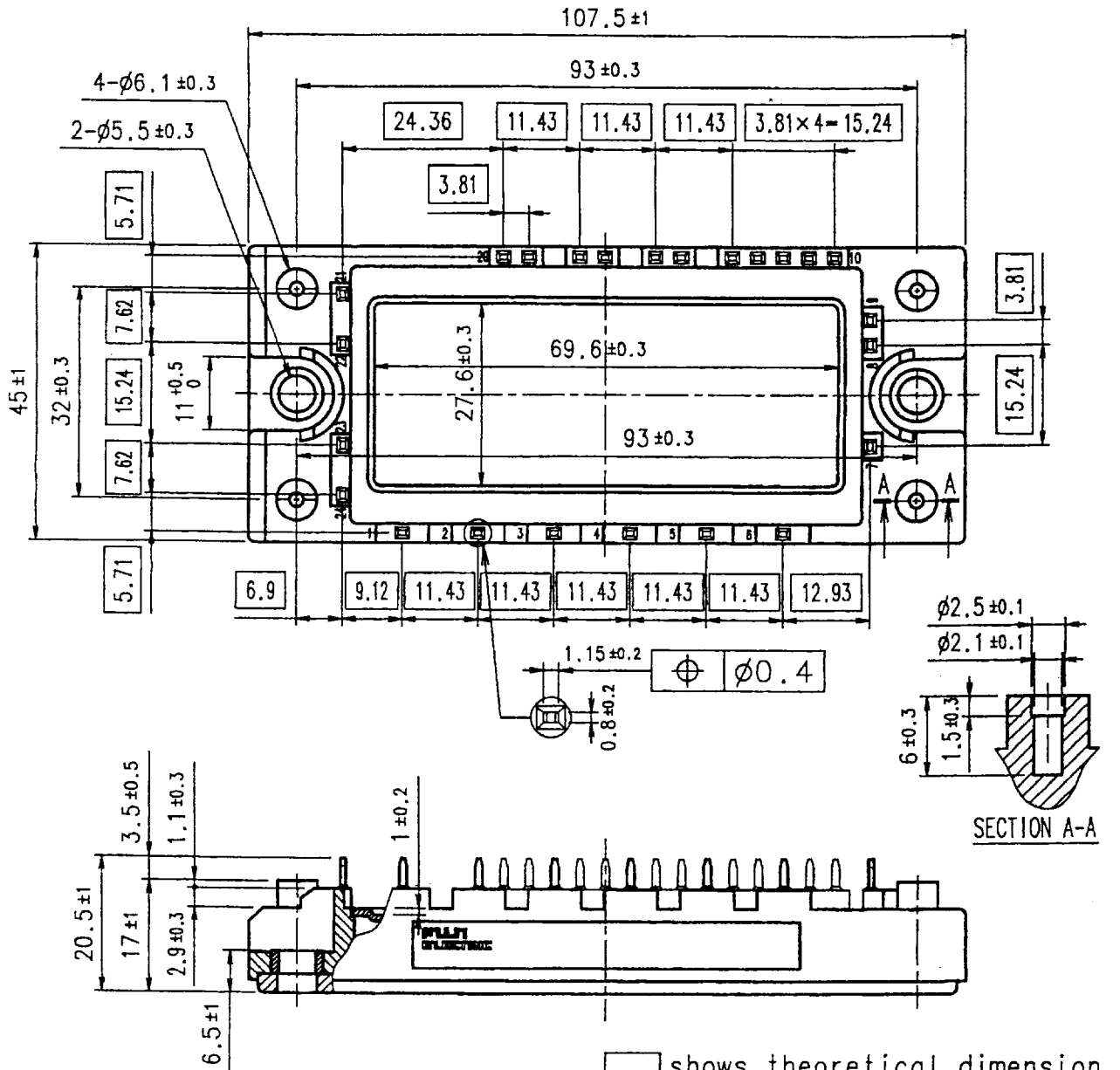

This material and the information herein is the property of Fuji Electric Co. Ltd. They shall be neither reproduced, copied, lent, or disclosed in any way whatsoever for the use of any third party nor used for the manufacturing purposes without the express written consent of Fuji Electric Co., Ltd.

2. Equivalent circuit

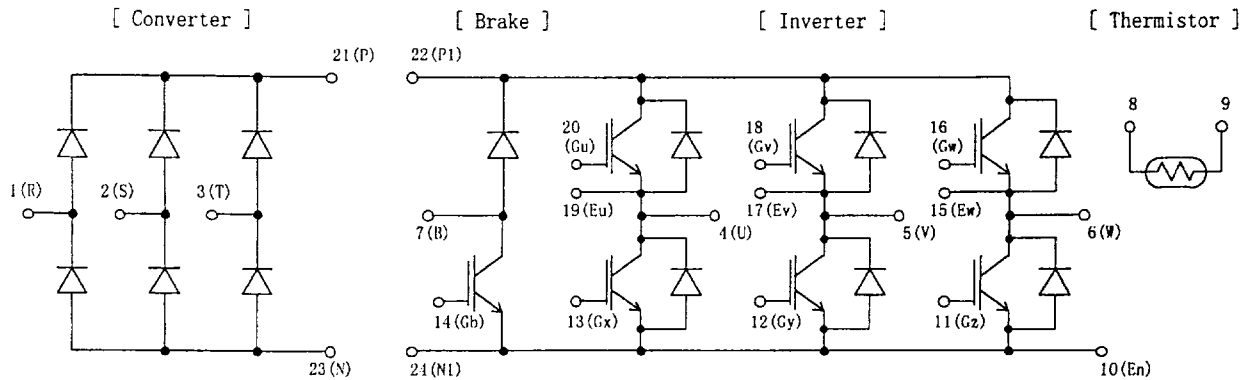

Fuji Electric Co., Ltd.

DWG. NO.

MS6M 0547

3 / 10

H04-004-03

3. Absolute Maximum Ratings (at Tc= 25C unless otherwise specified)

Items		Symbols	Conditions	Maximum Ratings	Units	
Inverter	Collector-Emitter voltage	VCES		1200	V	
	Gate-Emitter voltage	VGES		+20	V	
	Collector current	Ic	Continuous	Tc=25C	35	A
				Tc=80C	25	
		Icp	1ms	Tc=25C	70	A
				Tc=80C	50	
-Ic			25	A		
Collector Power Dissipation	Pc	1 device	180	W		
Brak	Collector-Emitter voltage	VCES		1200	V	
	Gate-Emitter voltage	VGES		+20	V	
	Collector current	Ic	Continuous	Tc=25C	25	A
				Tc=80C	15	
		Icp	1ms	Tc=25C	50	A
				Tc=80C	30	
Collector Power Dissipation	Pc	1 device	110	W		
Repetitive peak reverse Voltage(Diode)	VRRM		1200	V		
Converter	Repetitive peak reverse Voltage	VRRM		1600	V	
	Average Output Current	Io	50Hz/60Hz sine wave	25	A	
	Surge Current (Non-Repetitive)	IFSM	Tj=150C,10ms	260	A	
	I ² t (Non-Repetitive)	I ² t	half sine wave	338	A ² s	
Junction temperature	Tj		150	C		
Storage temperature	Tstg		-40~ +125	C		
Isolation voltage	between terminal and copper base ^{(*)1}	Viso	AC : 1min.	2500	V	
	between thermistor and others ^{(*)2}			2500		
Mounting Screw Torque ^{(*)3}				3.5	Nm	

(*)1 All terminals should be connected together when isolation test will be done.

(*)2 Terminal 8 and 9 should be connected together. Terminal 1 to 7 and 10 to 24 should be connected together and shorted to copper base.

(*)3 Recommendable Value : 2.5~3.5 Nm (M5)

4. Electrical characteristics (at T_j= 25C unless otherwise specified)

Items	Symbols	Conditions	Characteristics			Units		
			min.	typ.	Max.			
Inverter	Zero gate voltage Collector current	ICES	VGE = 0 V, VCE ^(*) = 1200 V		1.0	mA		
	Gate-Emitter leakage current	IGES	VCE = 0 V, VGE = +-20 V		200	nA		
	Gate-Emitter threshold voltage	VGE(th)	VCE = 20 V, Ic = 25 mA		5.5	7.2	8.5	V
	Collector-Emitter saturation voltage	VCE(sat)	VGE = 15 V, chip			2.1		V
			Ic = 25 A, terminal			2.2	2.6	
	Input capacitance	Cies	VGE = 0 V, VCE = 10 V f = 1 MHz		3000			pF
	Turn-on time	ton	Vcc = 600 V		0.35	1.2	us	
			Ic = 25 A		0.25	0.6		
			VGE = +15 V		0.1			
	Turn-off time	toff	RG = 51 ohm		0.45	1.0	us	
			0.08	0.3				
Forward on voltage	VF	IF = 25 A, chip			2.3		V	
		terminal			2.4	3.2		
Reverse recovery time	trr	IF = 25 A				350	ns	
Brake	Zero gate voltage Collector current	ICES	VGE = 0 V, VCE ^(*) = 1200 V		1.0		mA	
	Gate-Emitter leakage current	IGES	VCE = 0 V, VGE = +-20 V				200	nA
	Collector-Emitter saturation voltage	VCE(sat)	VGE = 15 V, chip			2.1		V
			Ic = 15 A, terminal			2.2	2.6	
	Turn-on time	ton	Vcc = 600 V		0.35	1.2	us	
			Ic = 15 A		0.25	0.6		
	Turn-off time	toff	VGE = +15 V		0.45	1.0	us	
RG = 82 ohm			0.08	0.3				
Reverse current	IRRM	VR = 1200 V				1.0	mA	
Converter	VFM	IF = 25 A, chip			1.1		V	
		terminal			1.2	1.5		
Reverse current	IRRM	VR = 1600 V				1.0	mA	
Thermistor	R	T = 25C		5000			ohm	
		T = 100C		465	495	520		
B value	B	T = 25/50C		3305	3375	3450	K	

This material and the information herein is the property of Fuji Electric Co., Ltd. They shall be neither reproduced, copied, lent, or disclosed in any way whatsoever for the use of any third party, nor used for the manufacturing purposes without the express written consent of Fuji Electric Co., Ltd.

5. Thermal resistance characteristics

Items	Symbols	Conditions	Characteristics			Units
			min.	typ.	Max.	
Thermal resistance (1 device)	Rth(j-c)	Inverter IGBT			0.69	C/W
		Inverter FWD			1.30	
		Brake IGBT			1.14	
		Converter Diode			0.90	
Contact Thermal resistance	Rth(c-f)	with Thermal Compound (*)		0.05		C/W

* This is the value which is defined mounting on the additional cooling fin with thermal compound.

Fuji Electric Co., Ltd.

DWG. NO.

MS6M 0547

5 / 10

a

6. Indication on module

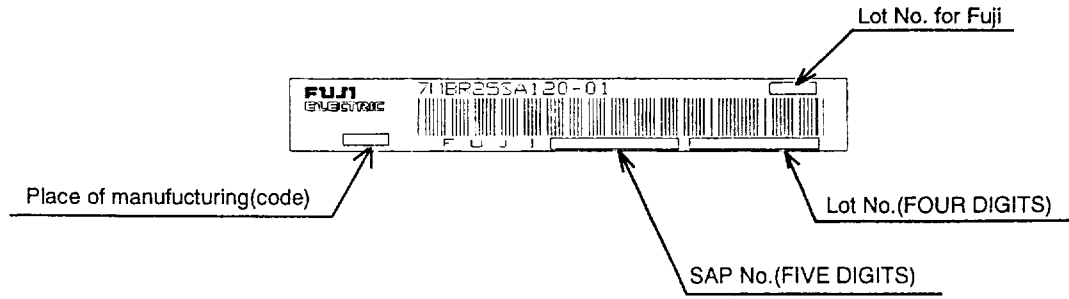

7. Applicable category

This specification is applied to Power Integrated Module named 7MBR25SA120-01 .

8. Storage and transportation notes

- The module should be stored at a standard temperature of 5 to 35°C and humidity of 45 to 75% .
- Store modules in a place with few temperature changes in order to avoid condensation on the module surface.
- Avoid exposure to corrosive gases and dust.
- Avoid excessive external force on the module.
- Store modules with unprocessed terminals.
- Do not drop or otherwise shock the modules when transporting.
- Please connect adequate fuse or protector of circuit between three-phase line and this product to prevent the equipment from causing secondary destruction.

This material and the information herein is the property of Fuji Electric Co. Ltd. They shall be neither reproduced, copied, lent, or disclosed in any way whatsoever for the use of any third party, nor used for the manufacturing purposes without the express written consent of Fuji Electric Co., Ltd.

9. Definitions of switching time

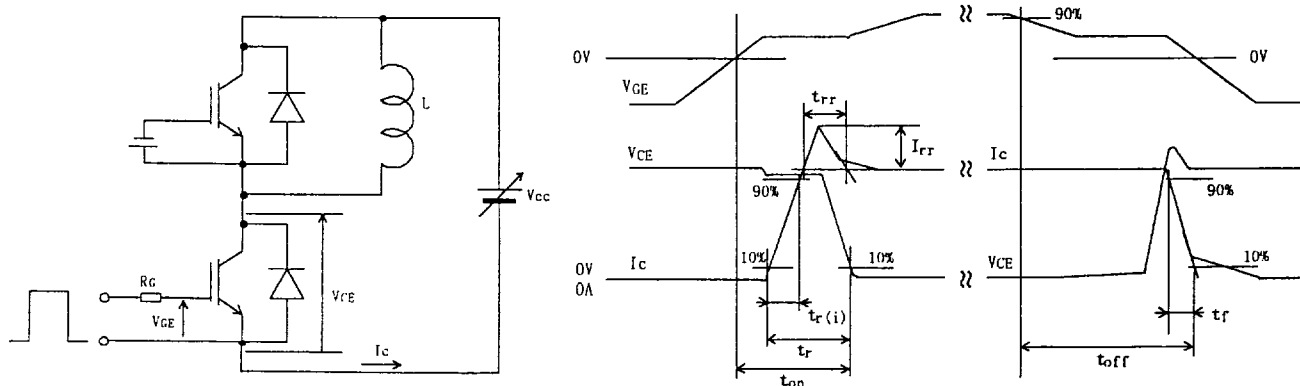

Fuji Electric Co.,Ltd.

DWG. NO.

MS6M 0547

6 / 10

a

This material and the information herein is the property of Fuji Electric Co., Ltd. They shall be neither reproduced, copied, lent, or disclosed in any way whatsoever for the use of any third party, nor used for the manufacturing purposes without the express written consent of Fuji Electric Co., Ltd.

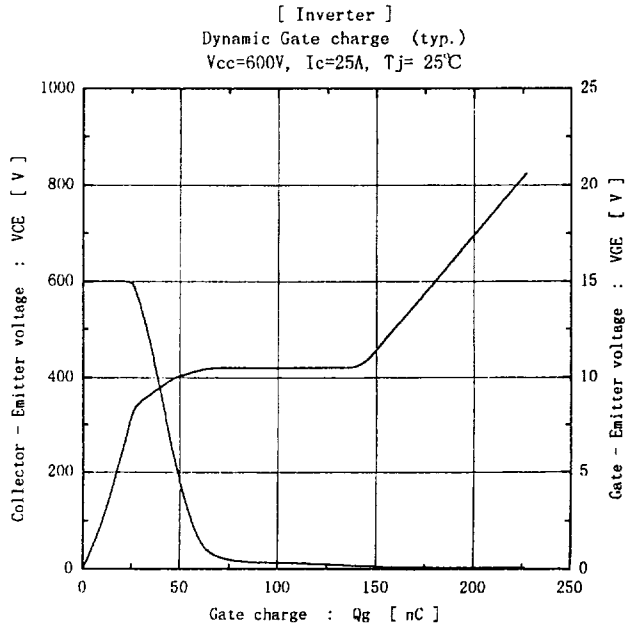
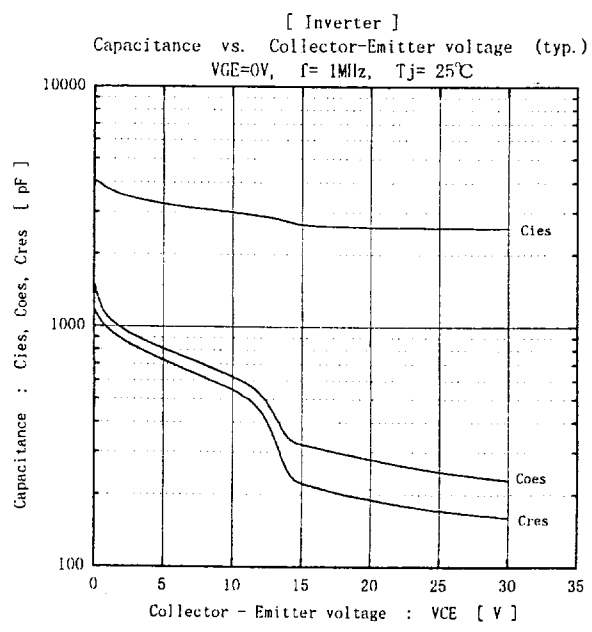
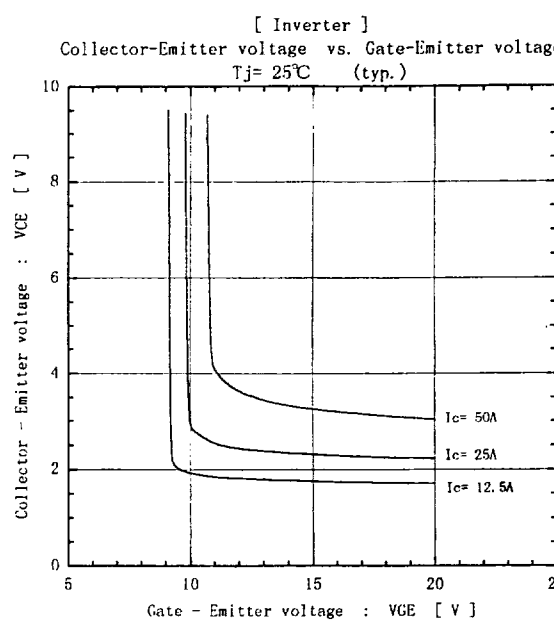
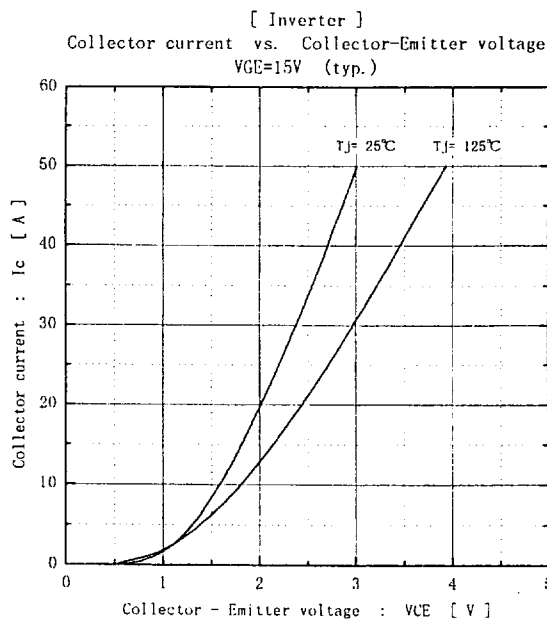
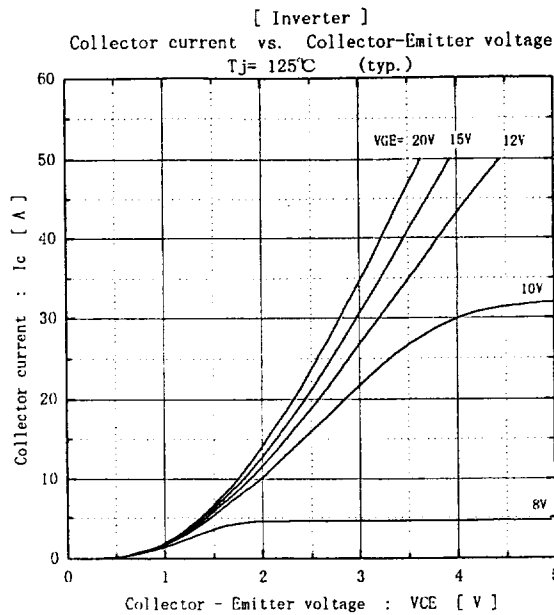
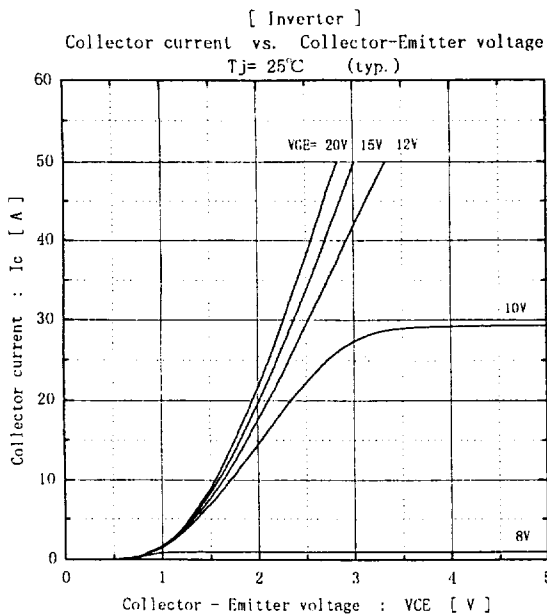

Fuji Electric Co., Ltd.

DWG. NO.

MS6M 0547

7 / 10

H04-004-03

This material and the information herein is the property of Fuji Electric Co., Ltd. They shall be neither reproduced, copied, lent, or disclosed in any way whatsoever for the use of any third party nor used for the manufacturing purposes without the express written consent of Fuji Electric Co., Ltd.

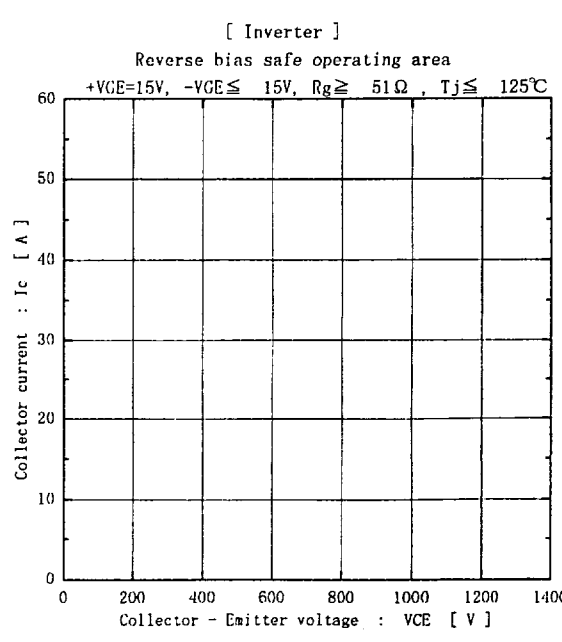
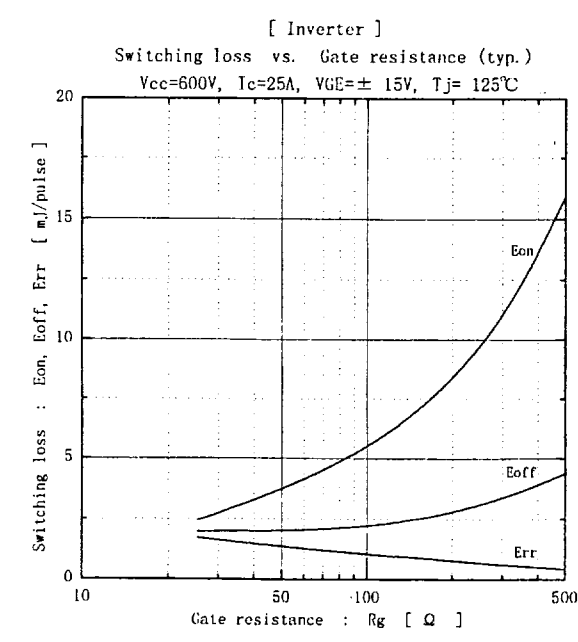
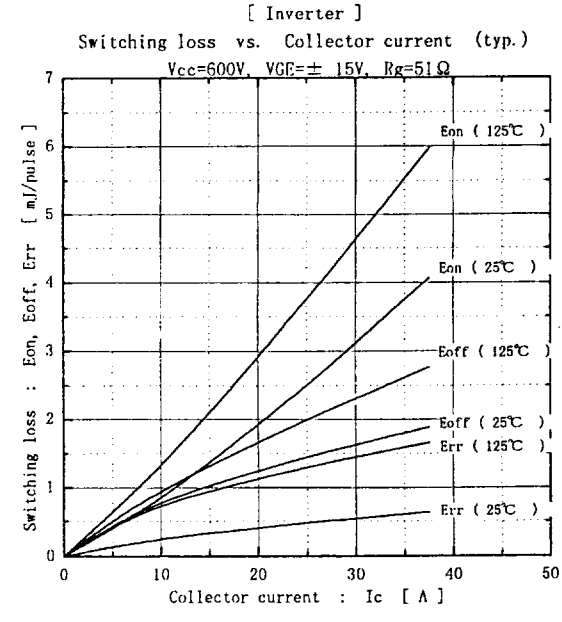
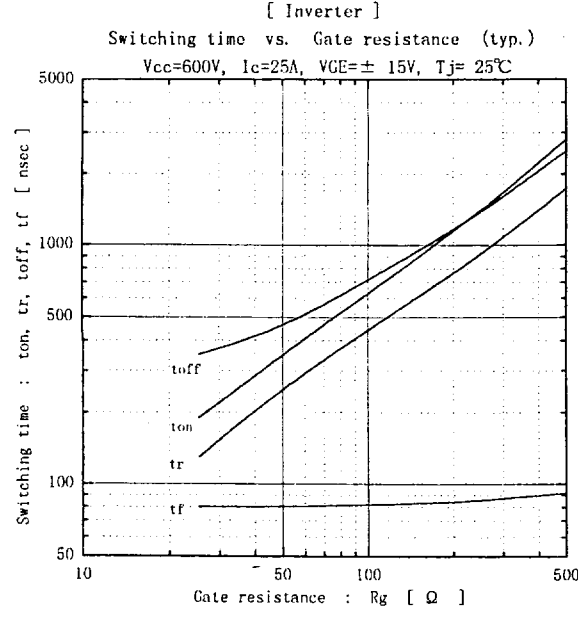
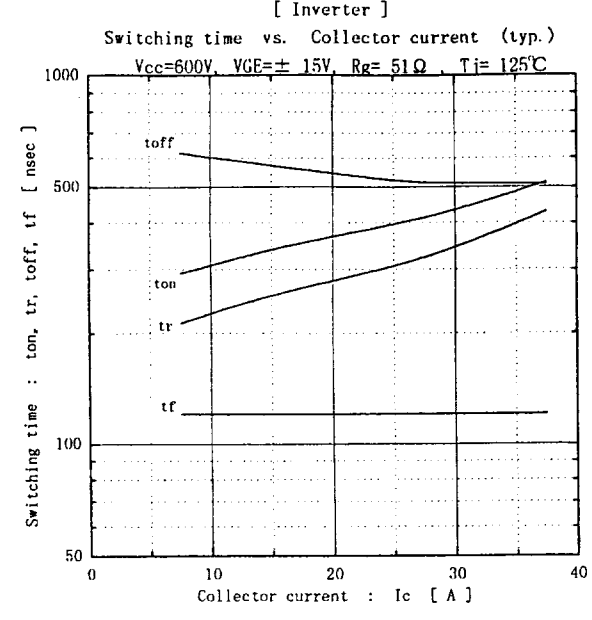
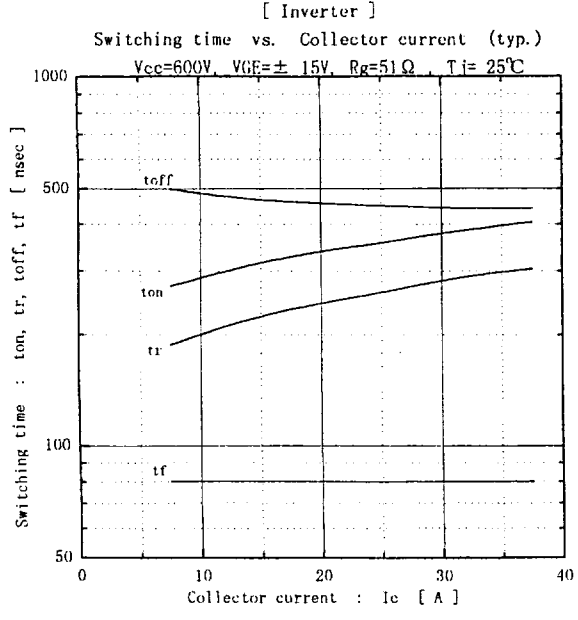

Fuji Electric Co., Ltd.

DWG. NO.

MS6M 0547

8 / 10

a	

This material and the information herein is the property of Fuji Electric Co. Ltd. They shall be neither reproduced, copied, lent, or disclosed in any way whatsoever for the use of any third party nor used for the manufacturing purposes without the express written consent of Fuji Electric Co., Ltd.

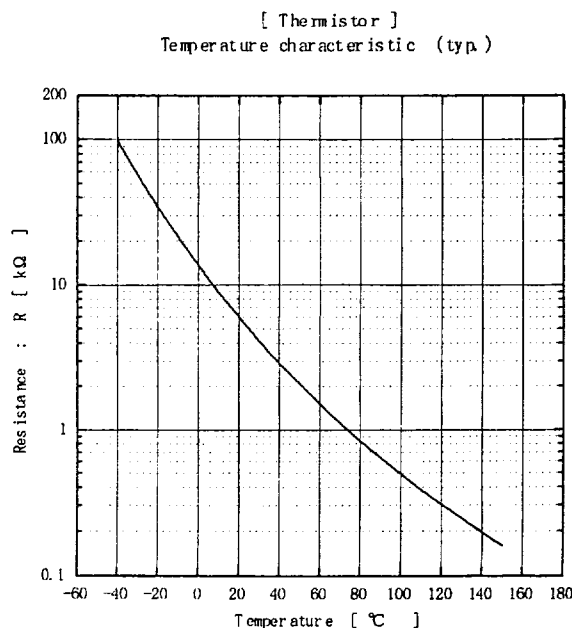
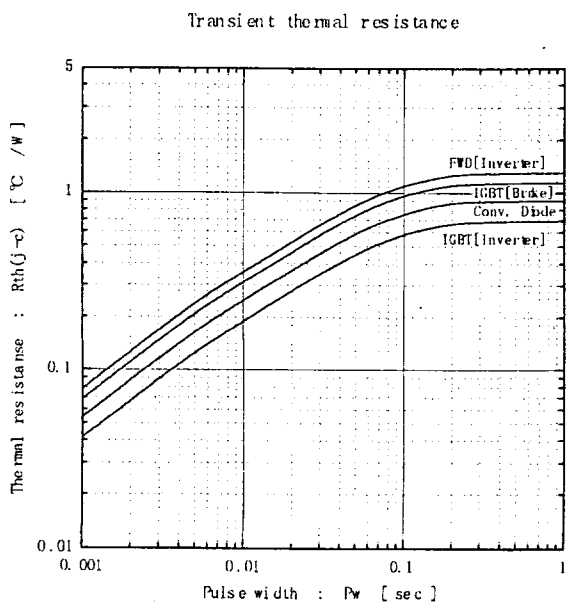
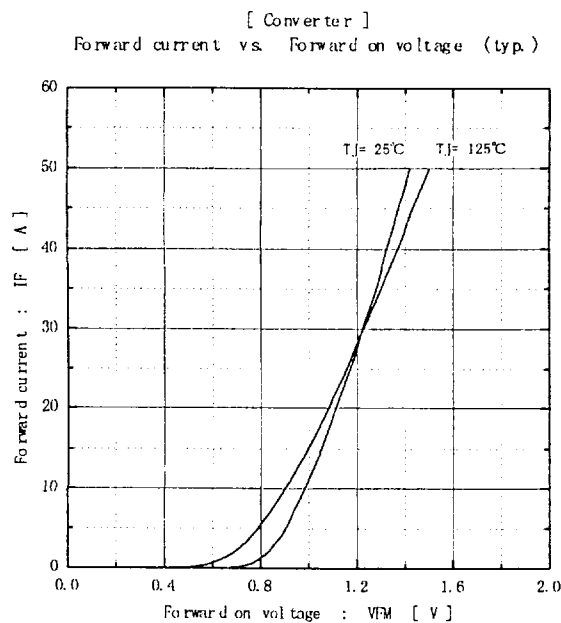
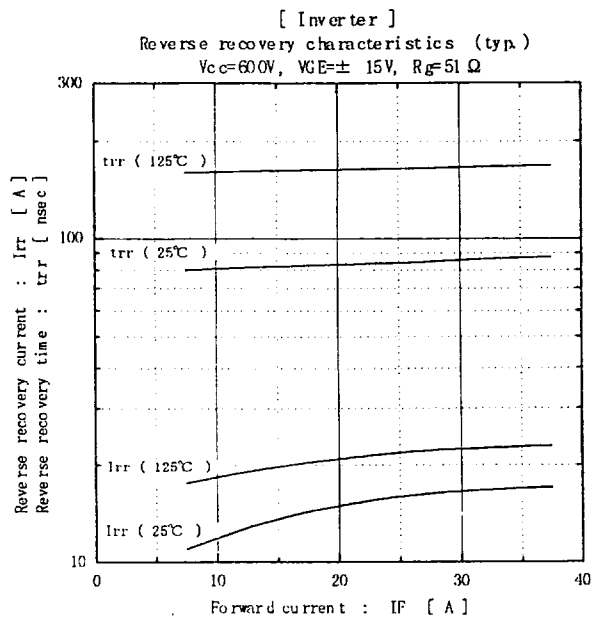
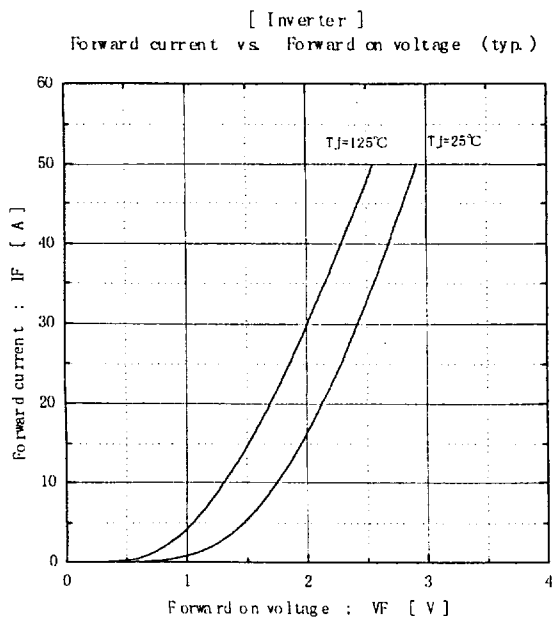

Fuji Electric Co., Ltd.

DWG. NO.

MS6M 0547

9 / 10

A

H04-004-03

This material and the information herein is the property of Fuji Electric Co. Ltd. They shall be neither reproduced, copied, lent, or disclosed in any way whatsoever for the use of any third party nor used for the manufacturing purposes without the express written consent of Fuji Electric Co. Ltd.

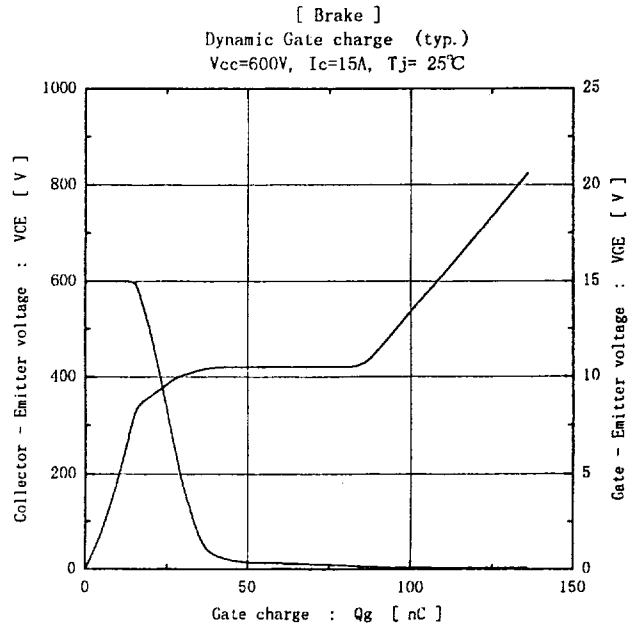
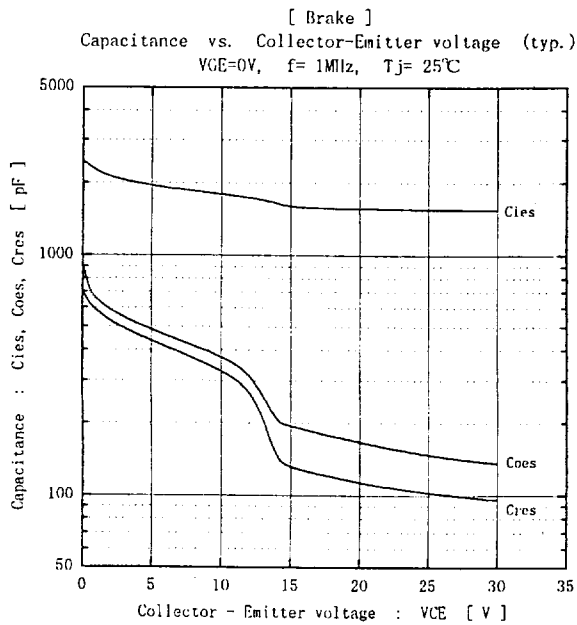
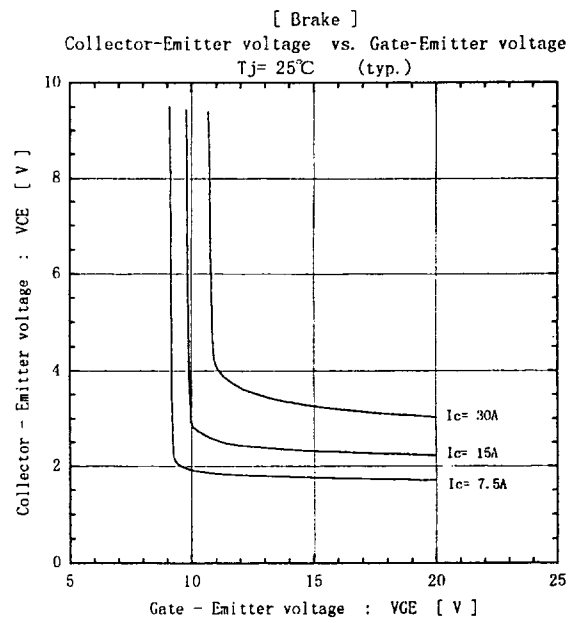
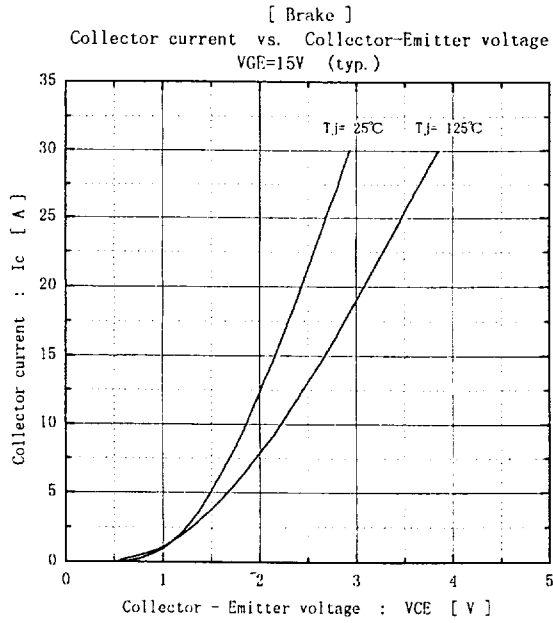
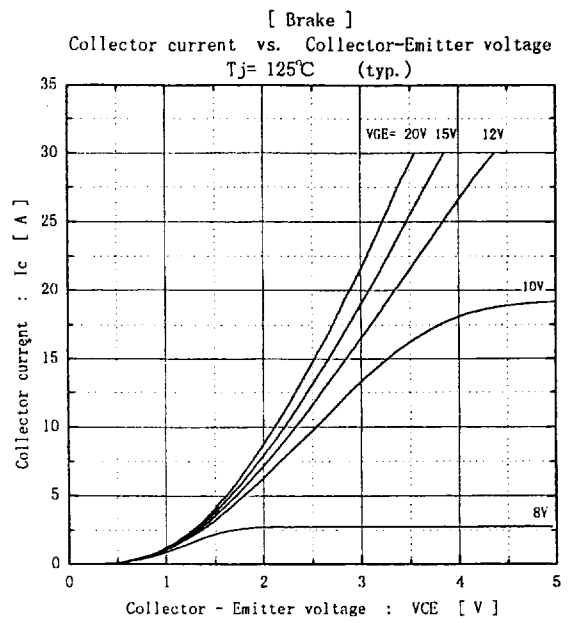
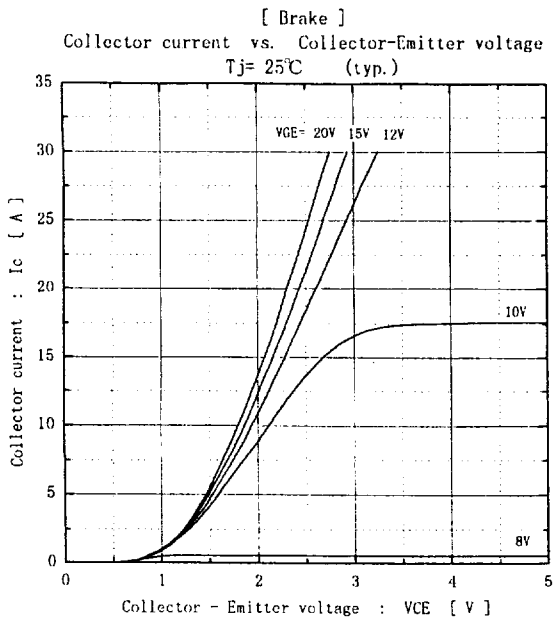

Fuji Electric Co., Ltd.

DWG. NO.

MS6M 0547

10 / 10

α

H04-004-03