

Data Sheet

Features

- For DCS applications
- Usable bandwidth 75 MHz
- Low loss
- High attenuation
- Single-ended input
- Balanced output
- Superior amplitude and phase balance
- Ceramic Surface Mount Package (SMP)
- Small size

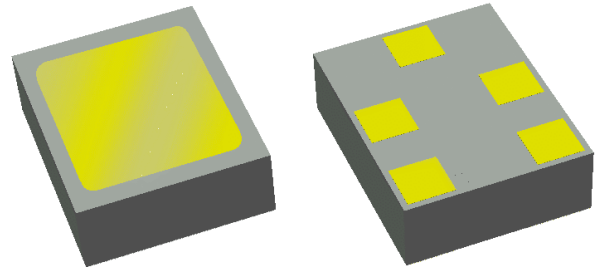

Package

Surface Mount 2.50 x 2.00 x 0.76 mm

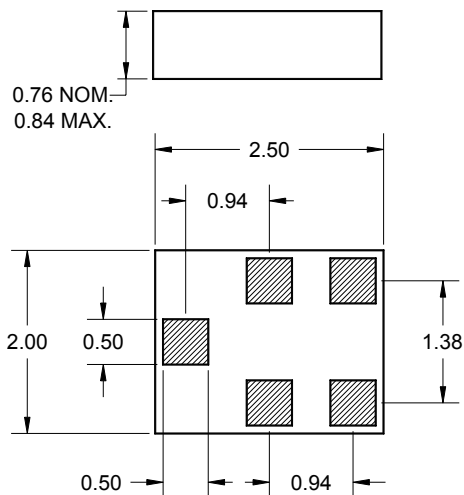

Pin Configuration

Bottom View

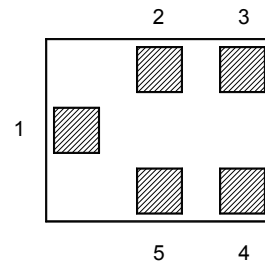

Pin No.	Description
1	Input
2,5	Case ground
3,4	Balanced output

Dimensions shown are nominal in millimeters
All tolerances are ± 0.10 mm

Body: Al_2O_3 ceramic
Lid: Kovar or Alloy 42, Au over Ni plated
Terminations: Au plating 0.5 - 1.0 μ m,
over a 2 - 6 μ m Ni plating

Data Sheet

Electrical Specifications ⁽¹⁾

Operating Temperature: ⁽²⁾ +25 °C

Parameter ⁽³⁾	Minimum	Typical	Maximum	Unit
Center Frequency	-	1842.5	-	MHz
Maximum Insertion Loss 1805 - 1880 MHz	-	2.5	2.9	dB
Absolute Attenuation				
DC - 1000 MHz	40	45	-	dB
1000 - 1710 MHz	30	34	-	dB
1710 - 1765 MHz	20	25	-	dB
1765 - 1785 MHz	12	17	-	dB
1920 - 1980 MHz	15	17	-	dB
1980 - 2090 MHz	20	27	-	dB
2090 - 3000 MHz	30	40	-	dB
3000 - 6000 MHz	40	50	-	dB
Passband Ripple ⁽⁴⁾ 1805 - 1880 MHz	-	0.7	1.0	dB
Input/Output Return Loss 1805 - 1880 MHz	8	10	-	dB
Output Amplitude Balance (S₃₁/S₂₁) 1805 - 1880 MHz	-	1.4	2	dB
Output Phase Balance $\phi(S_{31}) - \phi(S_{21})$ 1805 - 1880 MHz	165	180	190	degree
Source Impedance	-	50	-	Ω
Optimal Load Impedance (balanced) ⁽⁵⁾	-	200 18nH	-	Ω

Notes:

1. All specifications are based on the test circuit shown below
2. This specification is valid for room temperature only. The specification over the full temperature range(s) is available on the next page(s)
3. Electrical margin has been built into the design to account for the variations due to manufacturing tolerances
4. This is the maximum peak to adjacent valley amplitude change in passband
5. This is the optimum impedance for maximum power transfer

Test Circuit:

Actual matching values may vary due to PCB layout and parasitics

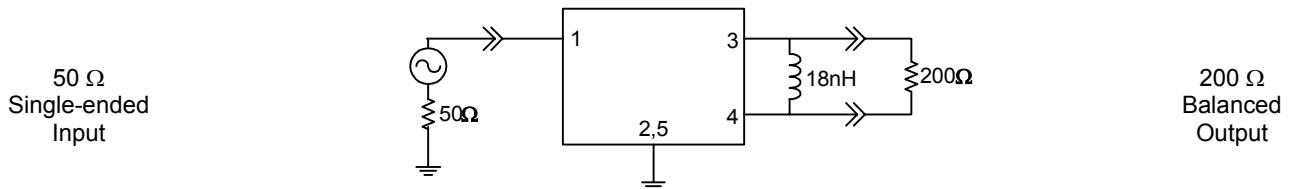

Data Sheet

Electrical Specifications ⁽¹⁾

Operating Temperature Range: ⁽²⁾ -30 to +80 °C

Parameter ⁽³⁾	Minimum	Typical	Maximum	Unit
Center Frequency	-	1842.5	-	MHz
Maximum Insertion Loss				
1805 - 1880 MHz	-	2.8	3.5	dB
1805 - 1880 MHz (+15 to +35 °C)	-	2.5	-	dB
Absolute Attenuation				
DC - 1000 MHz	40	45	-	dB
1000 - 1710 MHz	30	34	-	dB
1710 - 1765 MHz	20	25	-	dB
1765 - 1785 MHz	8	10	-	dB
1920 - 1980 MHz	15	17	-	dB
1980 - 2090 MHz	20	27	-	dB
2090 - 3000 MHz	30	40	-	dB
3000 - 6000 MHz	40	50	-	dB
Passband Ripple ⁽⁴⁾				
1805 - 1880 MHz	-	0.7	1.0	dB
Input/Output Return Loss				
1805 - 1880 MHz	8	10	-	dB
Output Amplitude Balance (S₃₁/S₂₁)				
1805 - 1880 MHz	-	1.4	2	dB
Output Phase Balance $\phi(S_{31}) - \phi(S_{21})$				
1805 - 1880 MHz	165	180	190	degree
Source Impedance	-	50	-	Ω
Optimal Load Impedance (balanced) ⁽⁵⁾	-	200 18nH	-	Ω

Notes:

1. All specifications are based on the test circuit shown below
2. In production, devices will be tested at room temperature to a guardbanded specification to ensure electrical compliance over temperature
3. Electrical margin has been built into the design to account for the variations due to temperature drift and manufacturing tolerances
4. This is the maximum peak to adjacent valley amplitude change in passband
5. This is the optimum impedance for maximum power transfer

Test Circuit:

Actual matching values may vary due to PCB layout and parasitics

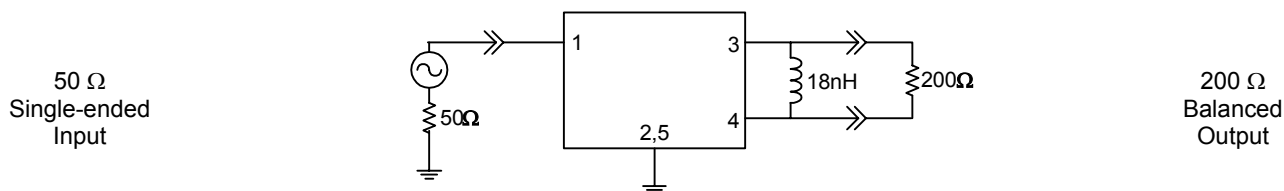

Data Sheet

Electrical Specifications ⁽¹⁾

Operating Temperature Range: ⁽²⁾ -30 to +80 °C

Parameter ⁽³⁾	Minimum	Typical	Maximum	Unit
Center Frequency	-	1842.5	-	MHz
Maximum Insertion Loss				
1805 - 1880 MHz	-	3.05	3.75	dB
1805 - 1880 MHz (+15 to +35 °C)	-	2.75	-	dB
Absolute Attenuation				
DC - 1000 MHz	40	45	-	dB
1000 - 1710 MHz	30	34	-	dB
1710 - 1765 MHz	20	25	-	dB
1765 - 1785 MHz	8	10	-	dB
1920 - 1980 MHz	15	17	-	dB
1980 - 2090 MHz	20	27	-	dB
2090 - 3000 MHz	30	40	-	dB
3000 - 6000 MHz	40	50	-	dB
Passband Ripple ⁽⁴⁾				
1805 - 1880 MHz	-	0.7	1.0	dB
Input/Output Return Loss				
1805 - 1880 MHz	8	10	-	dB
Output Amplitude Balance (S₃₁/S₂₁)				
1805 - 1880 MHz	-	1.4	2	dB
Output Phase Balance $\phi(S_{31}) - \phi(S_{21})$				
1805 - 1880 MHz	165	180	190	degree
Source Impedance	-	50	-	Ω
Optimal Load Impedance (balanced) ⁽⁴⁾	-	200 18nH	-	Ω

Notes:

1. All specifications are based on the test circuit shown below
2. In production, devices will be tested at room temperature to a guardbanded specification to ensure electrical compliance over temperature
3. Electrical margin has been built into the design to account for the variations due to temperature drift and manufacturing tolerances
4. This is the maximum peak to adjacent valley amplitude change in passband
5. This is the optimum impedance for maximum power transfer

Test Circuit:

Actual matching values may vary due to PCB layout and parasitics

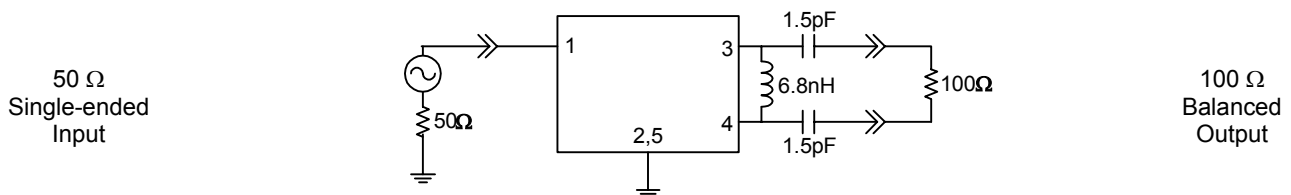

Data Sheet

Typical Performance (at +25°C)

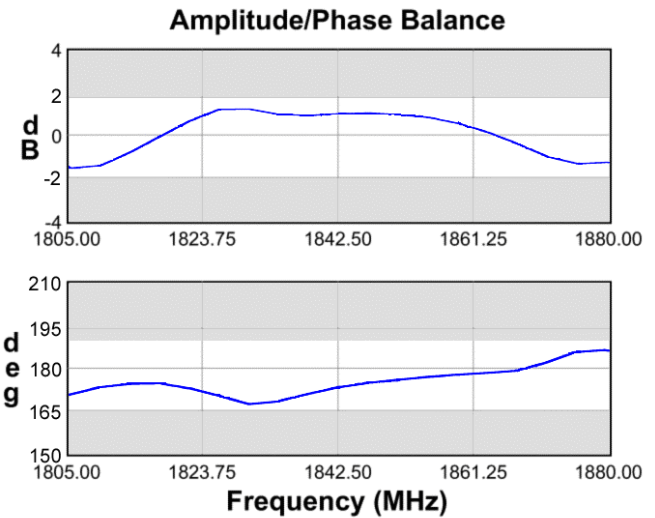
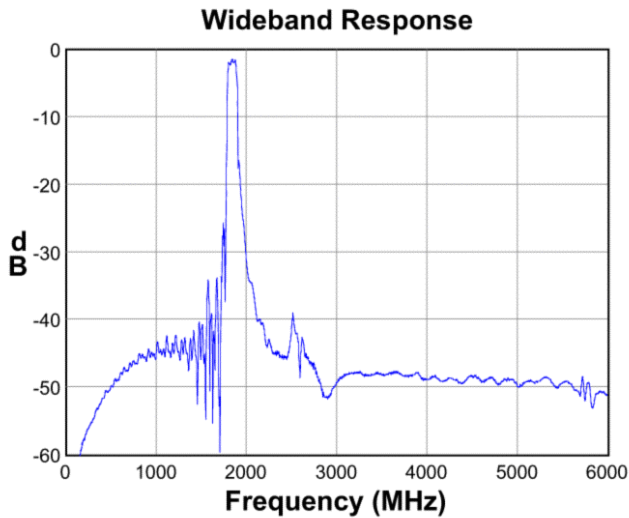
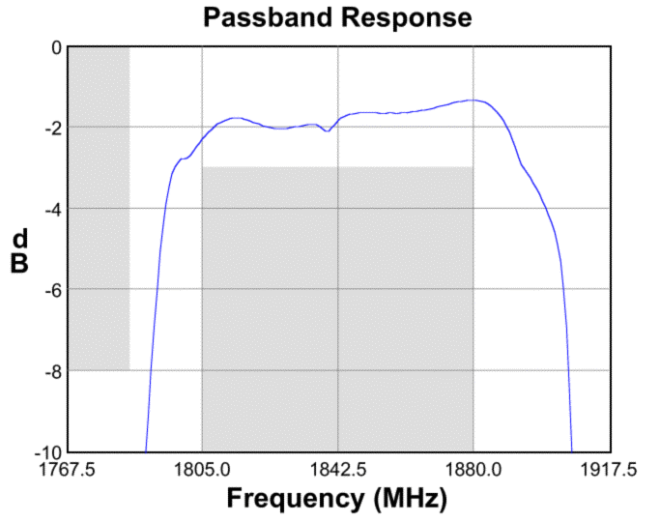
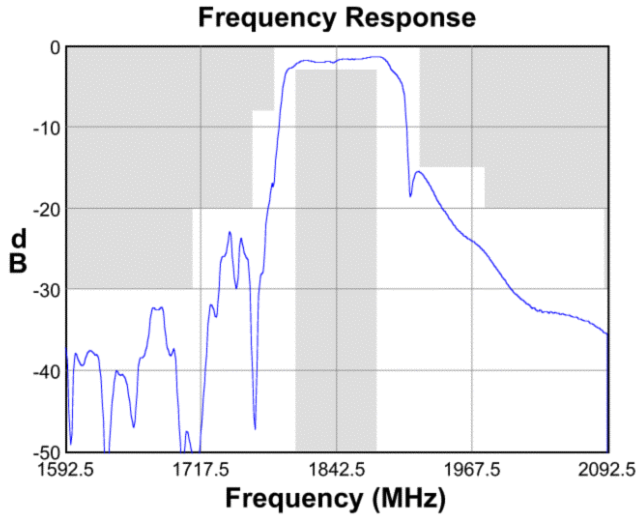

Input Smith Chart

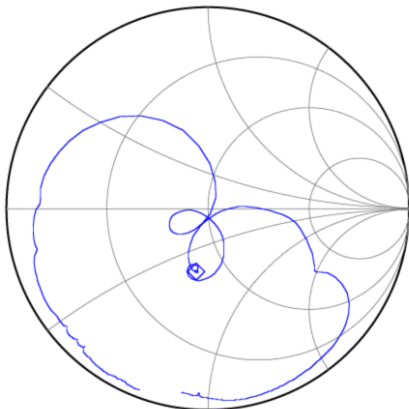

Output Smith Chart

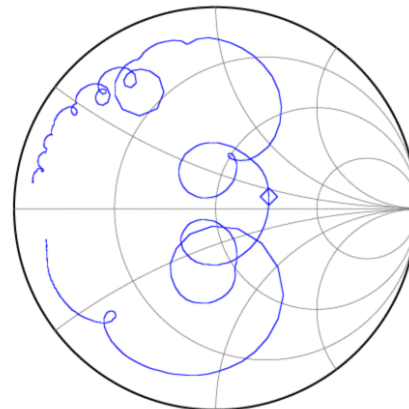

Data Sheet

Matching Schematics

Actual matching values may vary due to PCB layout and parasitics

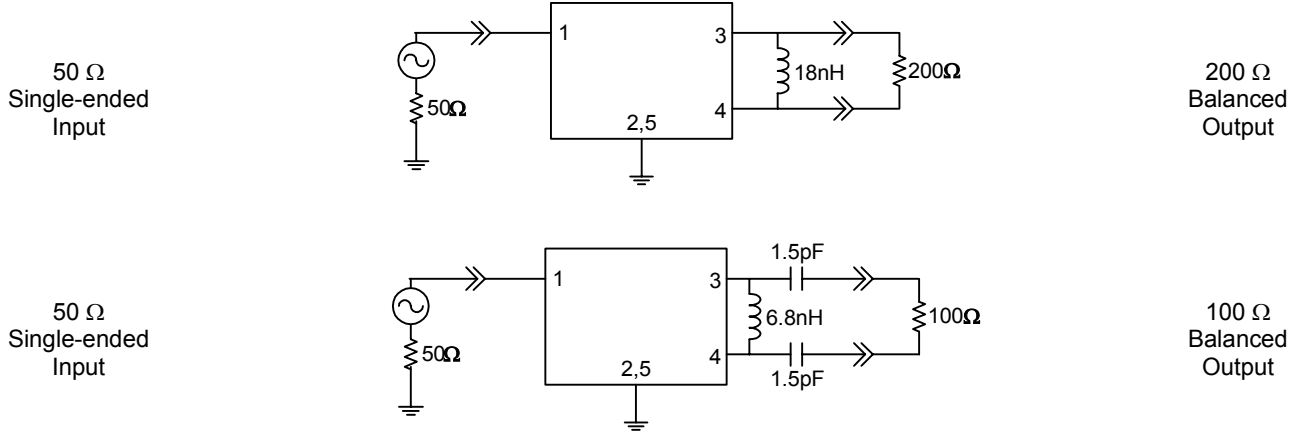

Marking

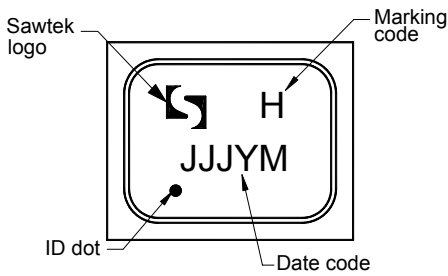

The date code consists of: JJJ = Julian day,
Y = last digit of year, M = manufacturing site code

PCB Footprint

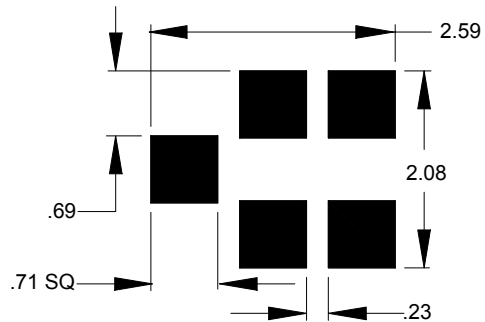

This footprint represents a recommendation only
Dimensions shown are nominal in millimeters

Tape and Reel

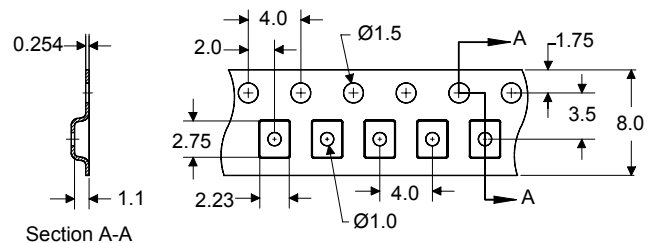
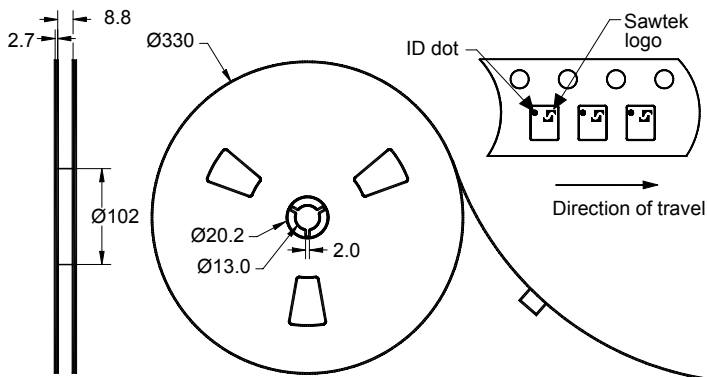

Dimensions shown are nominal in millimeters
Packaging quantity: 10000 units/reel

Data Sheet

Maximum Ratings

Parameter	Symbol	Minimum	Maximum	Unit
Operating Temperature Range	T	-30	+80	°C
Storage Temperature Range	T _{stg}	-40	+85	°C

Warnings

- Electrostatic Sensitive Device (ESD) 
- Avoid ultrasonic exposure

Links to Additional Technical Information

[PCB Layout Tips](#)

[Qualification Flowchart](#)

[Soldering Profile](#)

[S-Parameters](#)

[Other Technical Information](#)

Sawtek's liability is limited only to the Surface Acoustic Wave (SAW) component(s) described in this data sheet. Sawtek does not accept any liability for applications, processes, circuits or assemblies which are implemented using any Sawtek component described in this data sheet.

Contact Information



PO Box 609501
 Orlando, FL 32860-9501
 USA

Phone: +1 (407) 886-8860
 Fax: +1 (407) 886-7061
 Email: custservice@sawtek.com
 Web: www.sawtek.com

Or contact one of our worldwide
 Network of [sales offices](#),
[Representatives or distributors](#)