

TO-126 Plastic-Encapsulate Transistors

B772 TRANSISTOR(PNP)

FEATURES

Power dissipation

P_{CM} : 1.25W ($T_{amb}=25^{\circ}C$)

Collector current

I_{CM} : -3 A

Collector-base voltage

$V_{(BR)CBO}$: -40 V

Operating and storage junction temperature range

T_J, T_{stg} : $-55^{\circ}C$ to $+150^{\circ}C$

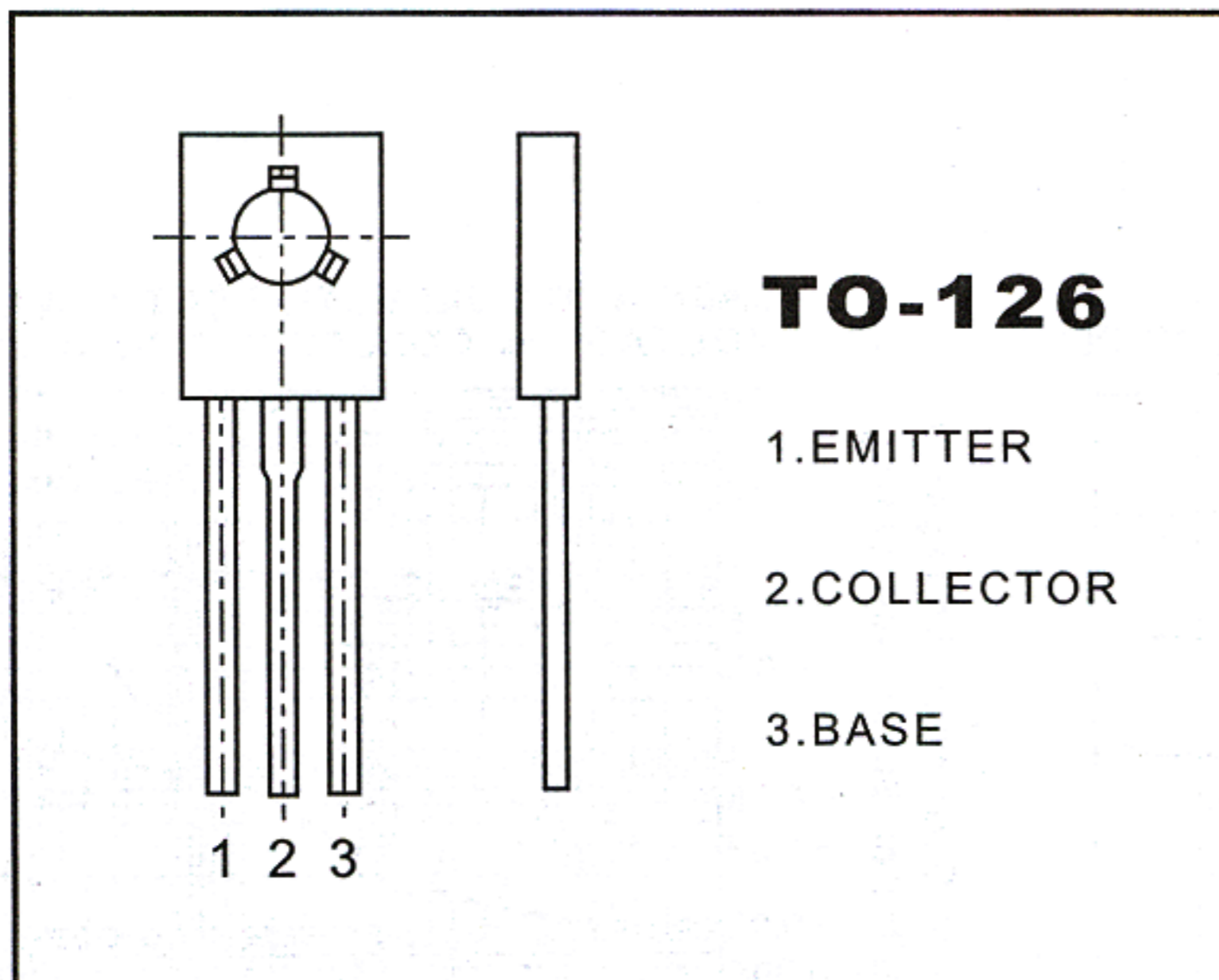

ELECTRICAL CHARACTERISTICS

($T_{amb}=25^{\circ}C$ unless otherwise specified)

Parameter	Symbol	Test conditions	MIN	MAX	UNIT
Collector-base breakdown voltage	$V_{(BR)CBO}$	$I_C = -100 \mu A, I_E = 0$	-40		V
Collector-emitter breakdown voltage	$V_{(BR)CEO}$	$I_C = -10 mA, I_B = 0$	-30		V
Emitter-base breakdown voltage	$V_{(BR)EBO}$	$I_E = -100 \mu A, I_C = 0$	-5		V
Collector cut-off current	I_{CBO}	$V_{CB} = -40 V, I_E = 0$		-1	μA
Collector cut-off current	I_{CEO}	$V_{CE} = -30 V, I_B = 0$		-1	μA
Emitter cut-off current	I_{EBO}	$V_{EB} = -6 V, I_C = 0$		-1	μA
DC current gain	$h_{FE(1)}$	$V_{CE} = -2 V, I_C = -1 A$	60	400	
	$h_{FE(2)}$	$V_{CE} = -2 V, I_C = -100 mA$	32		
Collector-emitter saturation voltage	V_{CEsat}	$I_C = -2 A, I_B = -0.2 A$		-0.5	V
Base-emitter saturation voltage	V_{BEsat}	$I_C = -2 A, I_B = -0.2 A$		-2	V
Transition frequency	f_T	$V_{CE} = -5 V, I_C = -0.1 A$ $f = 10 MHz$	50		MHz

CLASSIFICATION OF $h_{FE(1)}$

Rank	R	O	Y	GR
Range	60-120	100-200	160-320	200-400

TOTAL POWER DISSIPATION vs. AMBIENT TEMPERATURE

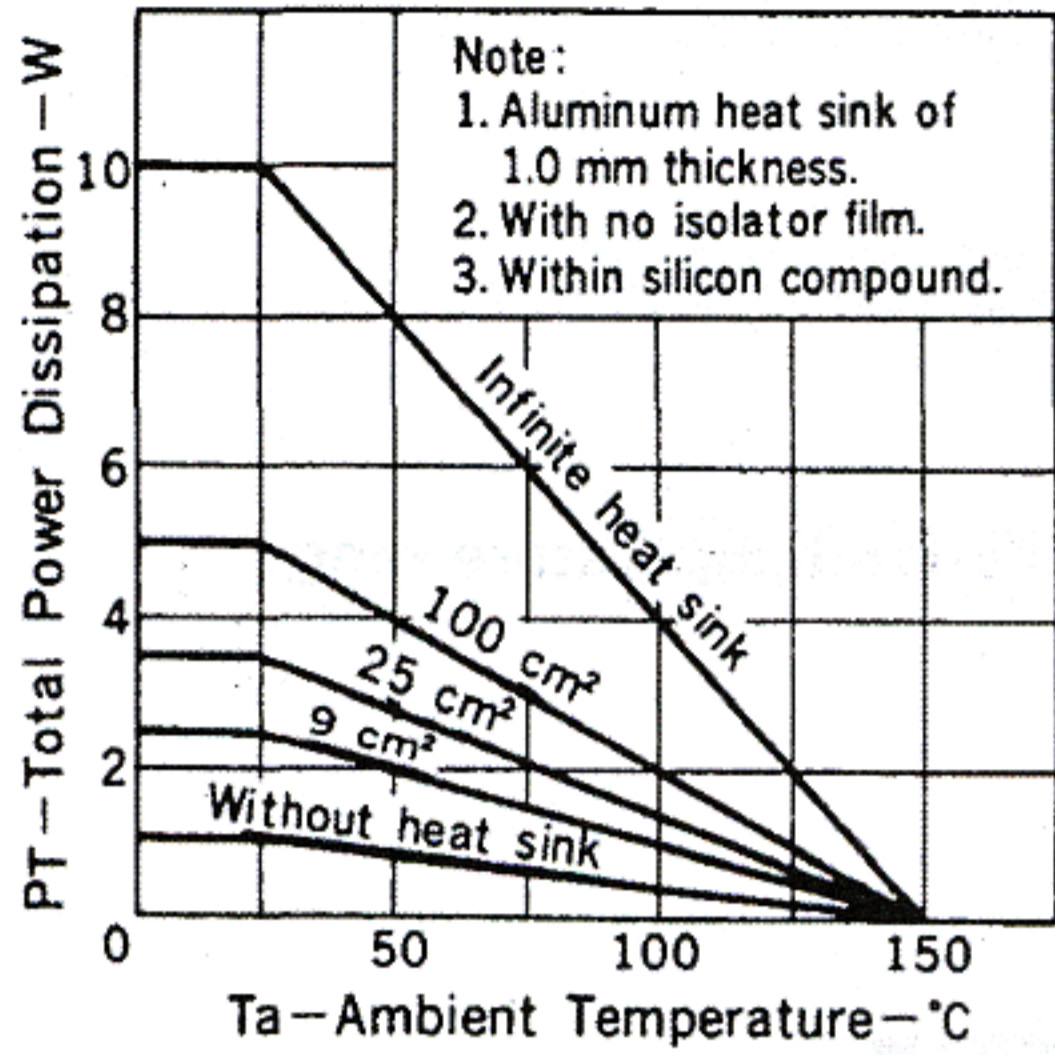

DERATING CURVES FOR ALL TYPES

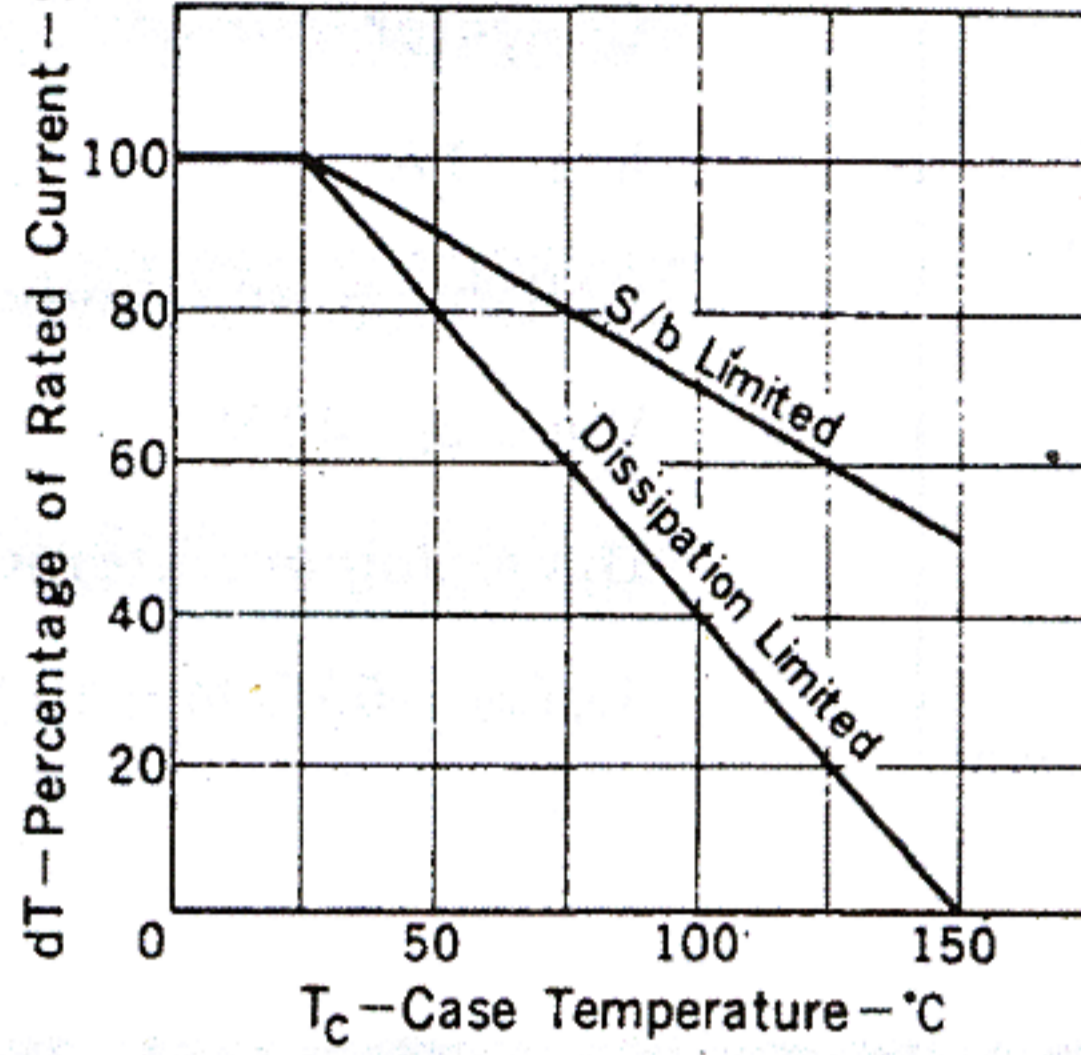

BASE AND COLLECTOR SATURATION VOLTAGE vs. COLLECTOR CURRENT

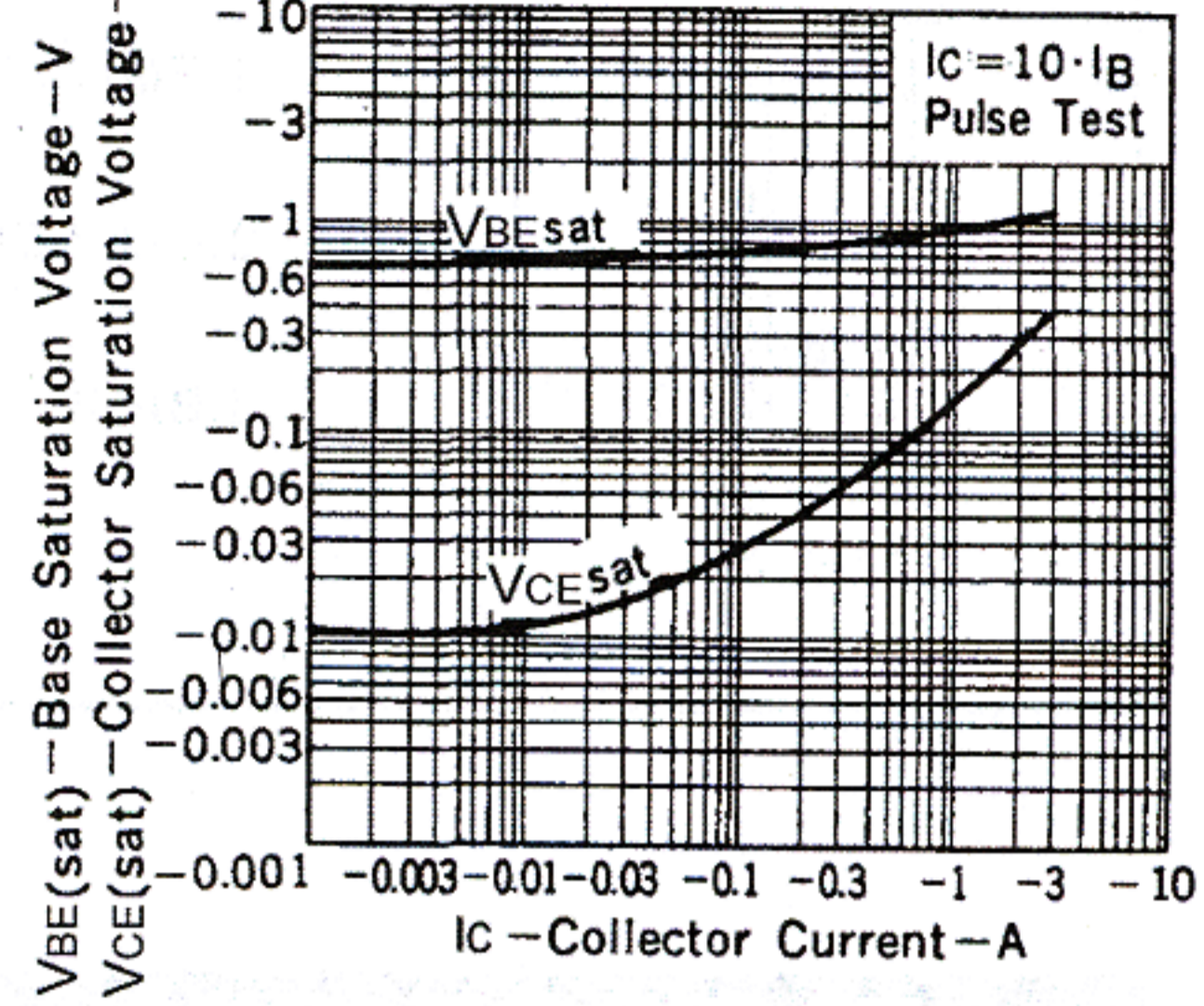

SAFE OPERATING AREAS

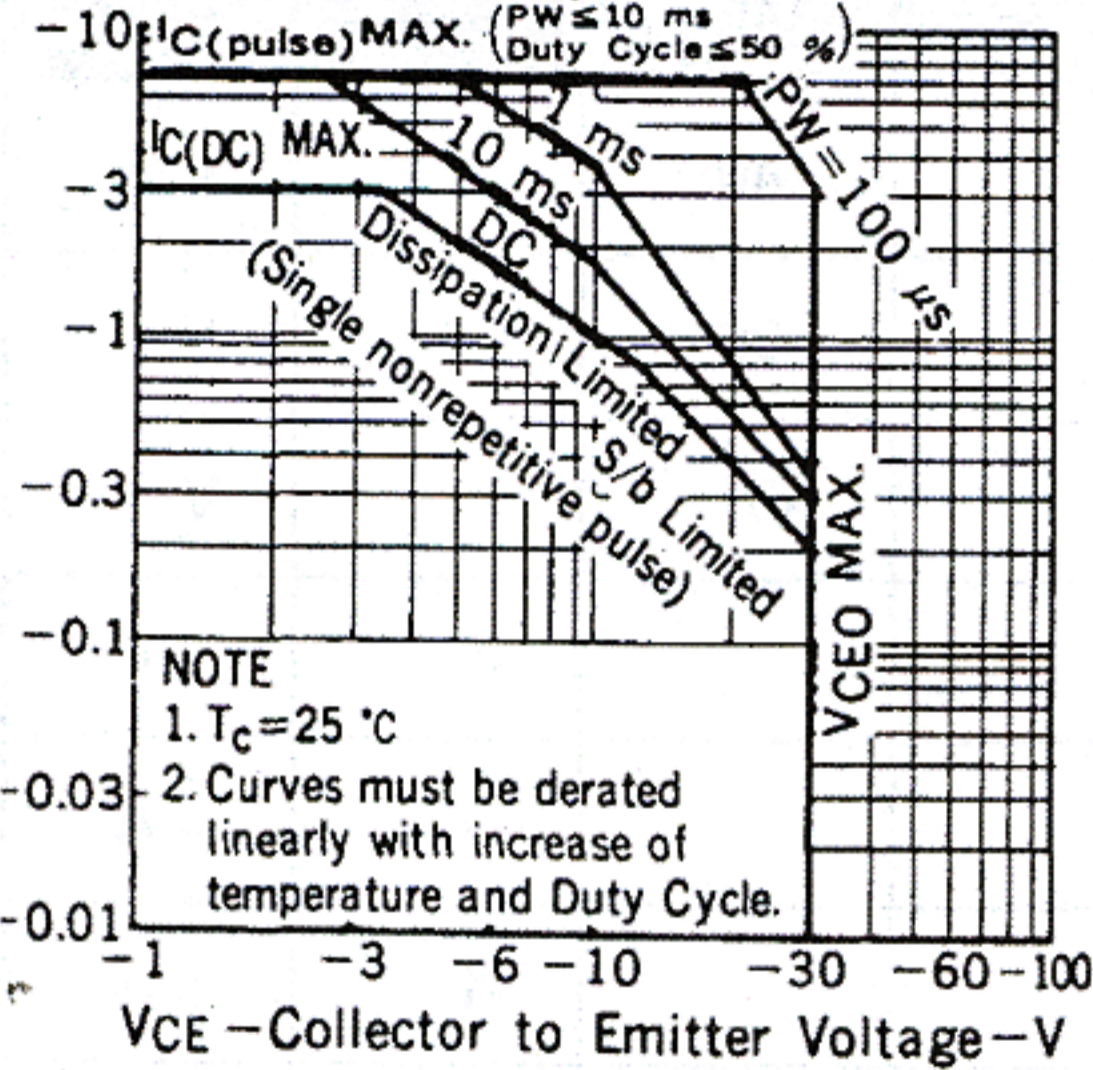

COLLECTOR CURRENT vs. COLLECTOR TO EMITTER VOLTAGE

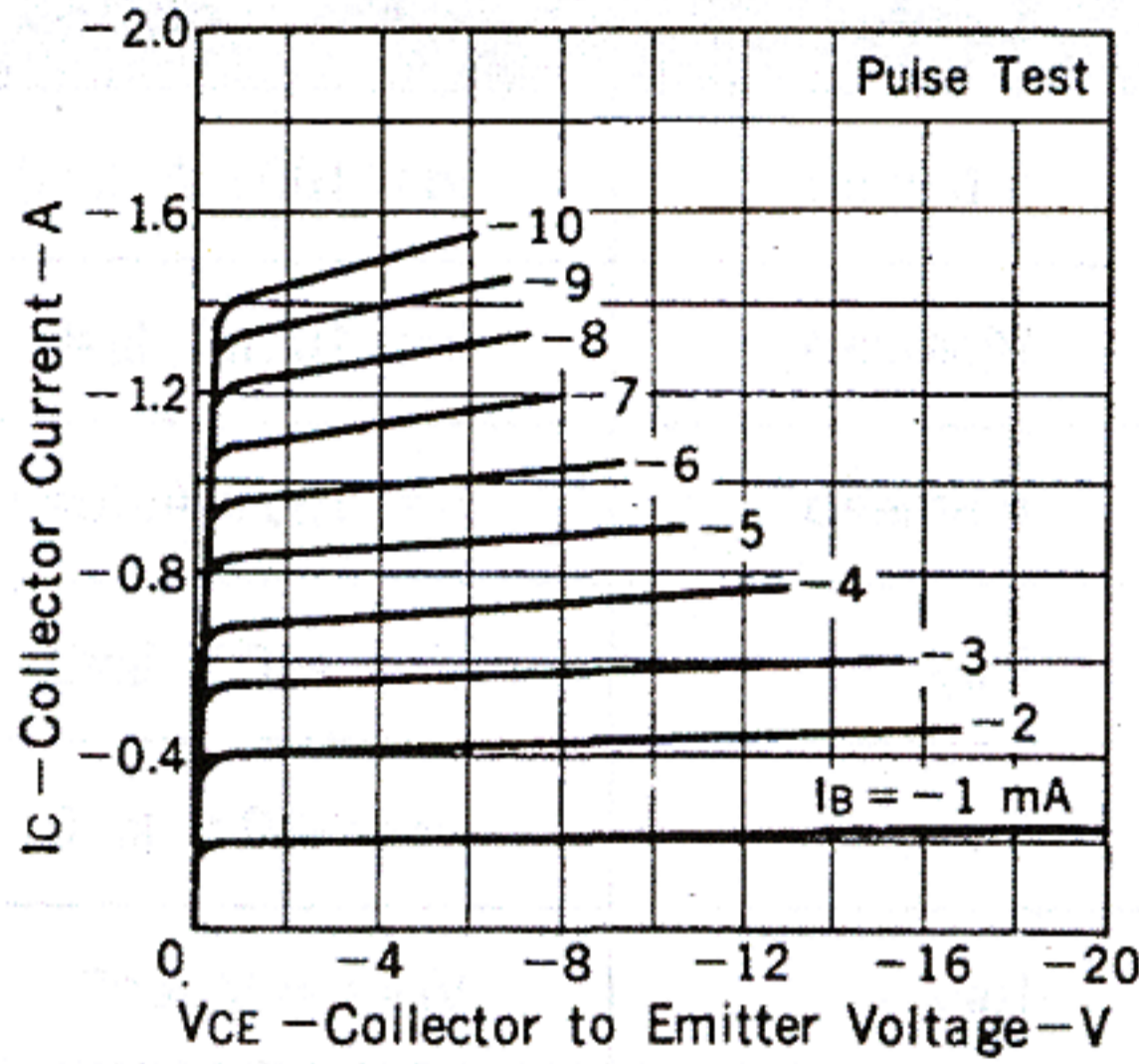

GAIN BANDWIDTH PRODUCT vs. COLLECTOR CURRENT

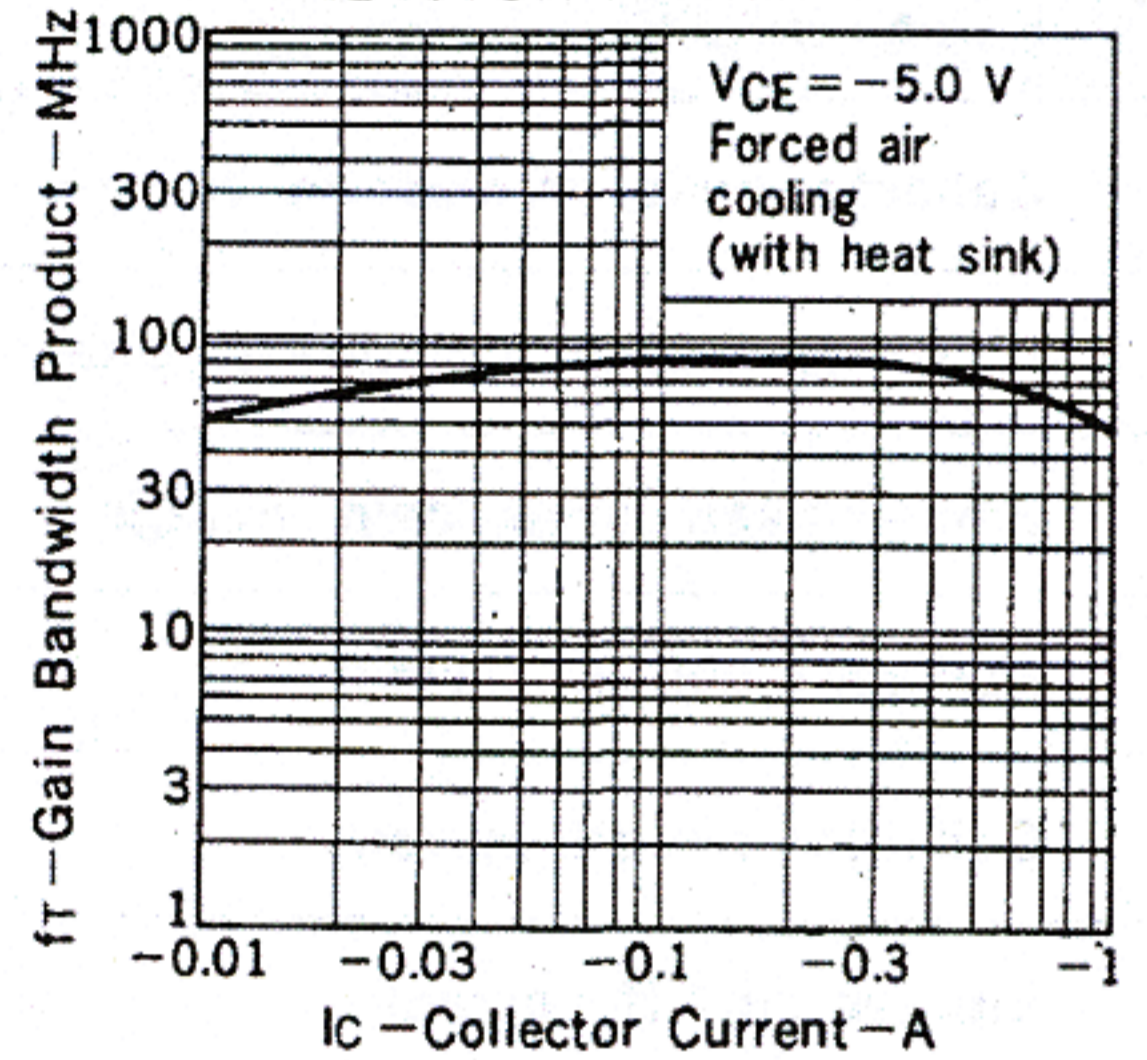

INPUT AND OUTPUT CAPACITANCE REVERSE VOLTAGE

