

DC-6.0 GHz InGaP HBT, MMIC or Packaged, Matched Gain Block Amplifier



May 2006 - Rev 23-May-06

CGB7007-SC (-BD)
RoHS

Features

- ✕ 34.0 dBm Output IP3 @ 850 MHz
- ✕ 4.5 dB Noise Figure @ 850 MHz
- ✕ 19.0 dB Gain @ 850 MHz
- ✕ 18.8 dBm P1dB @ 850 MHz
- ✕ Low Performance Variation Over Temperature
- ✕ Low Cost: Die Form or SOT-89 Package
- ✕ 100% DC On-Wafer Testing
- ✕ ESD Protection on All Die: >1000V HBM
- ✕ Low Thermal Resistance: <90°C/Watt

Applications

- ✕ PA Driver Amp, IF Amp, LO Buffer Amp
- ✕ Cellular, PCS, GSM, UMTS
- ✕ Wireless Data and SATCOM
- ✕ Transmit and Receive Functions
- ✕ CATV

Functional Block Diagram (SOT-89)

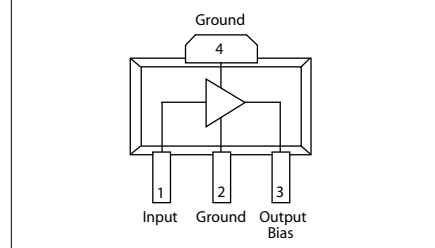

Absolute Maximum Ratings

Max Device Voltage	+6.0 V
Max Device Current	120 mA
Max Device Dissipated Power	0.58 W
RF Input Power	+17 dBm
Storage Temperature	-55°C to 150°C
Junction Temperature	150°C
Operating Temperature	-40°C to +85°C
Thermal Resistance	90° C/W
EDS (HBM)	1000 V

Operation of this device above any of these parameters may cause permanent damage.

Description

The CGB7007-SC (-BD) is a Darlington Configured, high dynamic range, utility gain block amplifier. Designed for applications operating within the DC to 6.0 GHz frequency range, Mimix's broadband, cascadable, gain block amplifiers are ideal solutions for transmit, receive and IF applications.

These MMIC amplifiers are available in bare die form or an industry standard SOT-89 package. Mimix's InGaP HBT technology and an industry low thermal resistance offers a

thermally robust and reliable gain block solution.

The InGaP HBT die have extra pads to enable thorough DC testing. This unique test capability and the inclusion of ESD protection on all die, significantly enhances the quality, reliability and ruggedness of these products.

With a single bypass capacitor, optional RF choke and two DC blocking capacitors, this gain block amplifier offers significant ease of use in a broad range of applications.

Electrical Characteristics

Unless otherwise specified, the following specifications are guaranteed at room temperature in a Mimix test fixture.

Parameter	Temperature (°C)	850 MHz			1950 MHz			2400 MHz			3500 MHz			Units
		Min.	Typ.	Max.	Min.	Typ.	Max.	Min.	Typ.	Max.	Min.	Typ.	Max.	
Small Signal Gain	+25	17.8	19.0	20.2	15.8	17.0	18.2	15.0	16.2	17.4		14.5		dB
	-40 to +85	17.6	19.0	20.4	15.6	17.0	18.4	14.8	16.2	17.6		14.5		dB
Output P1dB	+25	17.8	18.8		17.5	18.5		17.3	18.3			16.5		dBm
	-40 to +85	17.5	18.8		17.2	18.5		17.0	18.3			16.5		dBm
Output IP3	+25	32.5	34.0		31.3	32.8		30.5	32.0			30.0		dBm
	-40 to +85	31.5	34.0		30.8	32.8		30.0	32.0			30.0		dBm
Noise Figure	+25		4.5	5.3		4.7	5.5		4.8	5.6		5.0		dB
	-40 to +85		4.5	5.6		4.7	5.9		4.8	6.0		5.0		dB
Operating Current	+25	63	67	71	63	67	71	63	67	71		67		mA
	-40 to +85	60	67	74	60	67	74	60	67	74		67		mA
Input Return Loss	+25	16.0	21.0		12.0	17.0		9.5	14.0			14.0		dB
	-40 to +85	15.0	21.0		11.0	17.0		9.0	14.0			14.0		dB
Output Return Loss	+25	20.0	25.0		12.0	17.0		15.0	20.0			15.0		dB
	-40 to +85	19.0	25.0		11.0	17.0		14.0	20.0			15.0		dB
Pout @ -45 dBc, ACP IS-95, 9 Forward Channels	+25		12.5			13.0								dBm
	-40 to +85		12.5			13.0								dBm

Notes: 1. Test Conditions in Mimix eval board, Vs = 8 V, Id = 67 mA Typ., Rbias = 47 Ω, Zs = Zl = 50 Ω, OIP3 tone spacing = 1 MHz, Pout per tone = 3 dBm.
2. Values reflect performance in recommended application circuit.

DC-6.0 GHz InGaP HBT, MMIC or Packaged, Matched Gain Block Amplifier



May 2006 - Rev 23-May-06

CGB7007-SC (-BD)
RoHS

Typical S-Parameter and Noise Performance

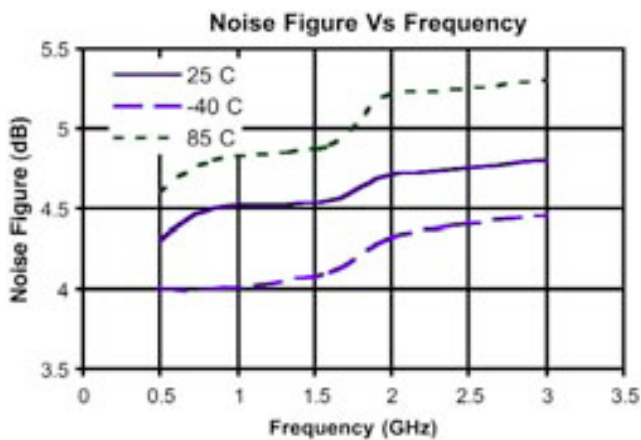
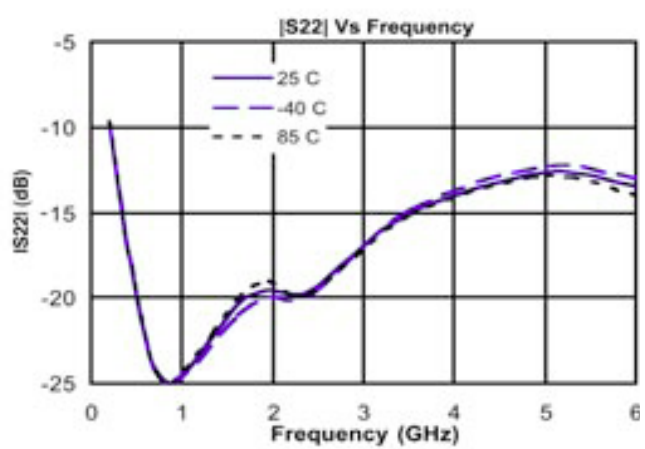
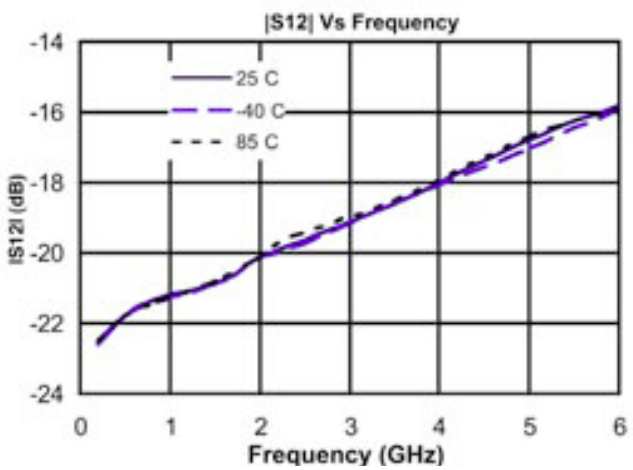
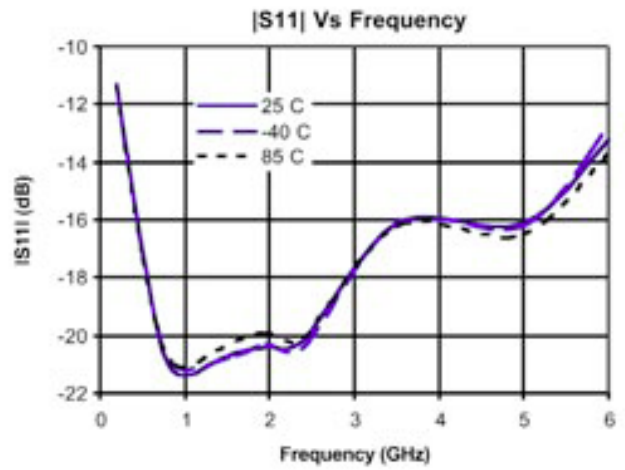
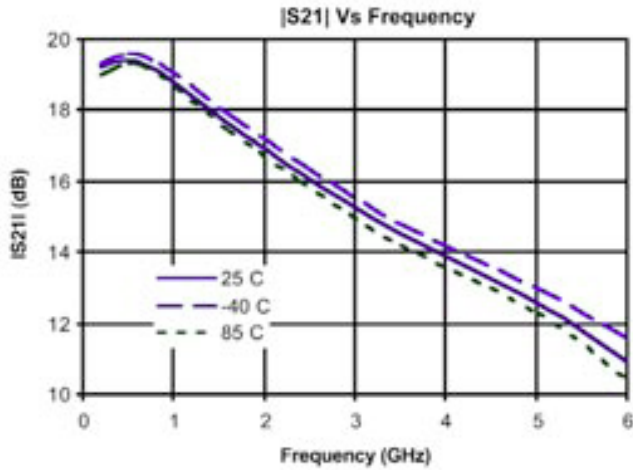

DC-6.0 GHz InGaP HBT, MMIC or Packaged, Matched Gain Block Amplifier



May 2006 - Rev 23-May-06

CGB7007-SC (-BD)
 RoHS

Typical Power and Linearity Performance

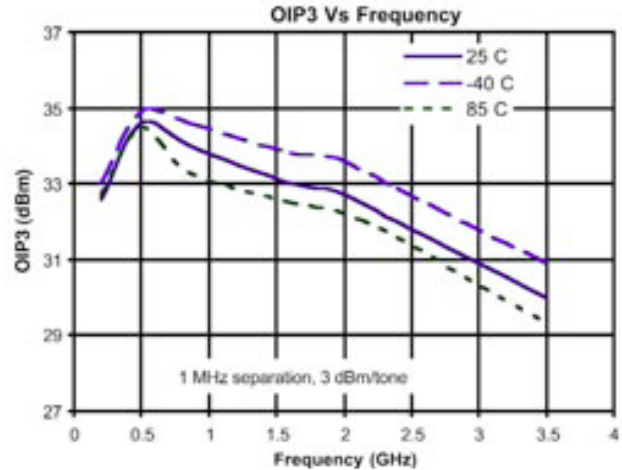
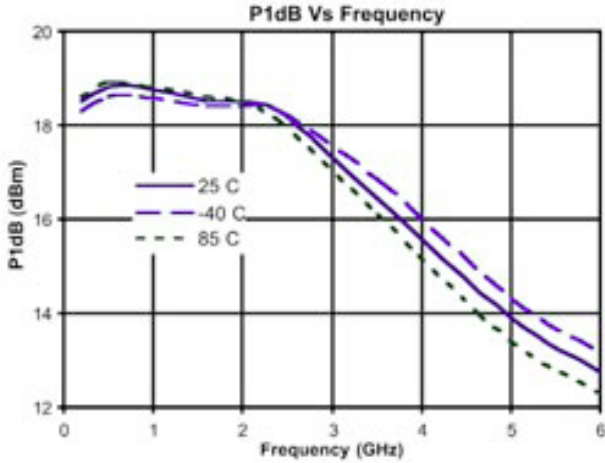

Linearity Performance - Base Station ACP - IS-95

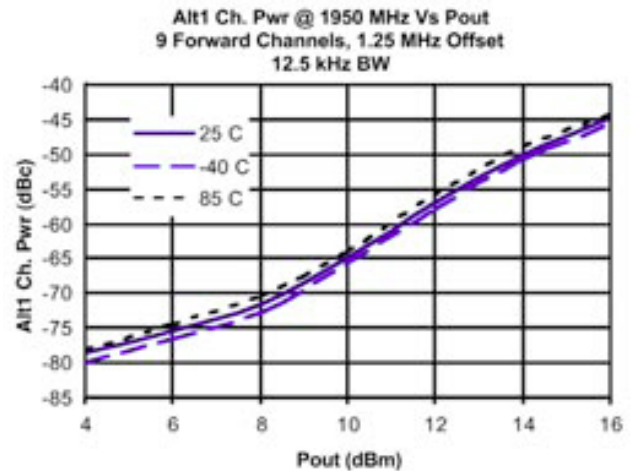
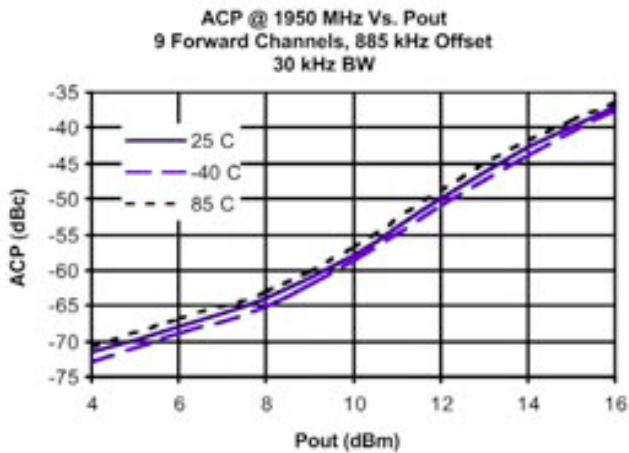
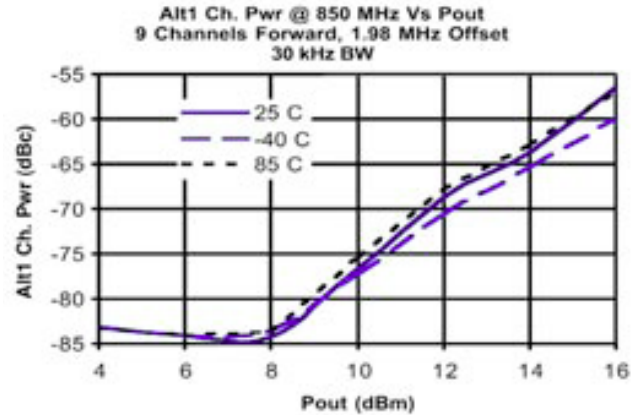
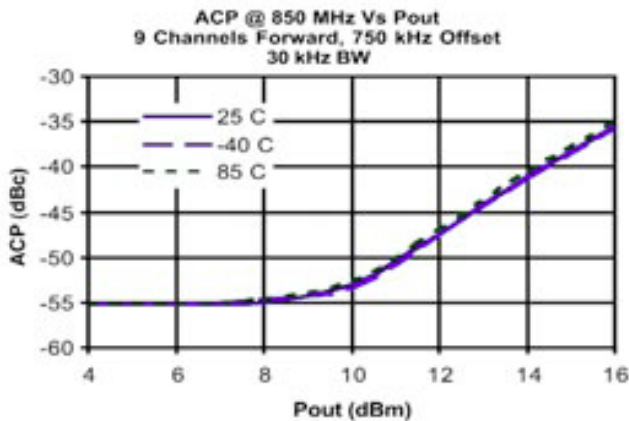

DC-6.0 GHz InGaP HBT, MMIC or Packaged, Matched Gain Block Amplifier



May 2006 - Rev 23-May-06

CGB7007-SC (-BD)
RoHS

Typical Scattering Parameters (Vd = +4.95V, Icc = 66.7 mA, T = 23°C, device in a 50 ohm system)

Frequency (MHz)	S ₁₁		S ₂₁		S ₁₂		S ₂₂	
	(Mag)	(Ang)	(Mag)	(Ang)	(Mag)	(Ang)	(Mag)	(Ang)
100	0.016	-27.0	9.84	173.9	0.079	-0.9	0.071	-13.6
200	0.019	-51.0	9.77	167.9	0.079	-1.5	0.074	-26.2
300	0.025	-64.5	9.71	162.0	0.079	-2.0	0.077	-38.7
400	0.030	-74.7	9.63	156.2	0.080	-3.1	0.081	-49.7
500	0.036	-81.7	9.53	150.5	0.080	-3.7	0.086	-59.8
600	0.042	-87.8	9.42	144.8	0.081	-4.5	0.091	-69.6
700	0.048	-93.5	9.30	139.1	0.081	-5.4	0.096	-78.6
800	0.054	-98.2	9.18	133.5	0.082	-6.1	0.102	-86.6
900	0.059	-102.0	9.04	128.0	0.083	-7.1	0.108	-94.3
1000	0.065	-106.5	8.91	122.6	0.084	-8.1	0.113	-101.7
1100	0.070	-110.2	8.76	117.2	0.085	-9.1	0.118	-108.7
1200	0.075	-113.6	8.61	111.8	0.086	-10.2	0.122	-114.9
1300	0.080	-117.0	8.45	106.6	0.088	-11.4	0.127	-121.1
1400	0.084	-120.3	8.29	101.4	0.089	-12.5	0.131	-126.8
1500	0.088	-123.1	8.14	96.3	0.090	-13.8	0.135	-132.5
1600	0.093	-126.1	7.98	91.2	0.091	-15.0	0.138	-137.8
1700	0.097	-128.9	7.82	86.3	0.093	-16.4	0.141	-142.7
1800	0.101	-131.7	7.66	81.3	0.094	-17.9	0.144	-147.9
1900	0.104	-134.3	7.51	76.5	0.096	-19.4	0.146	-152.6
2000	0.107	-136.9	7.36	71.7	0.097	-20.8	0.148	-157.6
2100	0.111	-139.7	7.21	67.0	0.099	-22.3	0.149	-162.1
2200	0.113	-142.2	7.05	62.3	0.100	-23.9	0.150	-166.6
2300	0.115	-144.8	6.91	57.7	0.102	-25.6	0.151	-171.1
2400	0.117	-147.4	6.77	53.1	0.103	-27.3	0.152	-175.5
2500	0.119	-149.9	6.63	48.6	0.105	-29.0	0.152	-180.0
2600	0.119	-152.2	6.49	44.2	0.107	-30.8	0.151	175.9
2700	0.120	-154.2	6.36	39.8	0.109	-32.5	0.150	171.9
2800	0.122	-156.7	6.24	35.5	0.110	-34.3	0.151	167.8
2900	0.123	-159.4	6.13	31.1	0.112	-36.1	0.152	163.6
3000	0.124	-161.8	6.01	26.8	0.114	-38.0	0.151	159.5
3100	0.125	-164.4	5.90	22.6	0.116	-39.9	0.152	155.3
3200	0.126	-167.1	5.80	18.3	0.118	-41.9	0.152	151.0
3300	0.127	-170.1	5.70	14.1	0.120	-44.1	0.153	146.7
3400	0.128	-173.4	5.61	9.9	0.122	-46.2	0.154	142.2
3500	0.129	-176.4	5.51	5.6	0.124	-48.3	0.155	137.7
3600	0.129	-179.5	5.41	1.4	0.126	-50.5	0.155	133.4
3700	0.129	177.1	5.32	-2.7	0.127	-52.7	0.156	128.7
3800	0.129	173.5	5.24	-6.9	0.129	-54.9	0.158	123.8
3900	0.129	169.4	5.15	-11.1	0.131	-57.3	0.159	119.1
4000	0.128	165.4	5.07	-15.2	0.133	-59.5	0.161	114.1
4100	0.127	161.1	4.99	-19.3	0.135	-61.9	0.163	109.1
4200	0.125	156.8	4.91	-23.5	0.137	-64.3	0.166	104.0
4300	0.123	151.8	4.84	-27.6	0.139	-66.7	0.169	98.7
4400	0.122	146.5	4.77	-31.7	0.141	-69.1	0.174	93.3
4500	0.119	140.8	4.69	-35.9	0.143	-71.7	0.178	87.9
4600	0.118	135.4	4.62	-39.9	0.145	-74.2	0.182	82.7
4700	0.115	129.5	4.56	-44.1	0.146	-76.7	0.187	77.6
4800	0.113	122.7	4.49	-48.2	0.148	-79.3	0.194	72.4
4900	0.112	115.2	4.43	-52.3	0.150	-82.0	0.201	67.2
5000	0.112	107.3	4.36	-56.5	0.152	-84.6	0.209	61.8

Continues Next Page. S-Parameter Data Files are available on-line at: www.mimixbroadband.com

Mimix Broadband, Inc., 10795 Rockley Rd., Houston, Texas 77099
Tel: 281.988.4600 Fax: 281.988.4615 mimixbroadband.com

Page 4 of 7

Characteristic Data and Specifications are subject to change without notice. ©2006 Mimix Broadband, Inc.
Export of this item may require appropriate export licensing from the U.S. Government. In purchasing these parts, U.S. Domestic customers accept their obligation to be compliant with U.S. Export Laws.

DC-6.0 GHz InGaP HBT, MMIC or Packaged, Matched Gain Block Amplifier



May 2006 - Rev 23-May-06

CGB7007-SC (-BD)
RoHS

Typical Scattering Parameters (Vd = +4.95V, Icc = 66.7 mA, T = 23°C, device in a 50 ohm system)

Frequency (MHz)	S ₁₁		S ₂₁		S ₁₂		S ₂₂	
	(Mag)	(Ang)	(Mag)	(Ang)	(Mag)	(Ang)	(Mag)	(Ang)
5100	0.112	99.7	4.30	-60.6	0.153	-87.4	0.216	56.6
5200	0.113	92.0	4.24	-64.7	0.155	-90.0	0.223	51.7
5300	0.114	83.8	4.18	-68.9	0.156	-92.8	0.232	46.9
5400	0.117	74.5	4.12	-73.1	0.158	-95.6	0.242	41.8
5500	0.122	65.8	4.06	-77.3	0.159	-98.4	0.252	36.6
5600	0.128	57.6	4.00	-81.4	0.161	-101.3	0.262	31.8
5700	0.135	49.7	3.94	-85.7	0.162	-104.2	0.273	27.2
5800	0.142	41.7	3.88	-89.9	0.163	-107.1	0.284	22.3
5900	0.151	33.5	3.82	-94.2	0.164	-110.2	0.297	17.3
6000	0.163	25.9	3.76	-98.5	0.165	-113.2	0.310	12.6
6100	0.176	19.1	3.70	-102.7	0.166	-116.1	0.323	8.0
6200	0.188	12.6	3.63	-107.1	0.166	-119.2	0.337	3.5
6300	0.201	6.2	3.57	-111.4	0.167	-122.3	0.350	-0.9
6400	0.215	-0.3	3.51	-115.7	0.167	-125.4	0.364	-5.4
6500	0.230	-6.4	3.44	-120.0	0.167	-128.6	0.378	-9.8
6600	0.247	-11.9	3.37	-124.3	0.167	-131.7	0.392	-14.1
6700	0.262	-17.0	3.31	-128.6	0.167	-134.7	0.406	-18.3
6800	0.277	-22.1	3.24	-132.9	0.166	-137.8	0.419	-22.3
6900	0.292	-27.3	3.17	-137.2	0.166	-140.9	0.432	-26.3
7000	0.308	-32.6	3.10	-141.5	0.165	-144.1	0.446	-30.4
7100	0.324	-37.5	3.02	-145.8	0.164	-147.2	0.458	-34.3
7200	0.341	-42.0	2.95	-150.0	0.163	-150.3	0.471	-38.4
7300	0.356	-46.4	2.88	-154.2	0.161	-153.4	0.481	-42.2
7400	0.369	-51.0	2.81	-158.5	0.160	-156.4	0.492	-45.9
7500	0.383	-55.7	2.73	-162.7	0.159	-159.6	0.502	-49.8
7600	0.399	-60.1	2.66	-166.8	0.157	-162.6	0.513	-53.6
7700	0.414	-64.2	2.59	-170.9	0.155	-165.5	0.523	-57.3
7800	0.427	-68.2	2.51	-174.9	0.153	-168.4	0.531	-60.9
7900	0.438	-72.1	2.44	-179.0	0.151	-171.3	0.539	-64.4
8000	0.449	-76.3	2.37	-177.0	0.148	-174.1	0.547	-67.7
8100	0.461	-80.4	2.30	-173.1	0.146	-176.9	0.555	-71.0
8200	0.473	-84.1	2.23	-169.3	0.144	-179.6	0.564	-74.3
8300	0.483	-87.5	2.16	-165.5	0.142	-177.8	0.571	-77.4
8400	0.490	-91.0	2.10	-161.9	0.140	-175.2	0.575	-80.4
8500	0.496	-94.6	2.04	-158.1	0.137	-172.7	0.580	-83.3
8600	0.503	-98.4	1.98	-154.4	0.135	-170.0	0.585	-86.3
8700	0.511	-101.9	1.92	-150.8	0.133	-167.5	0.589	-89.2
8800	0.517	-105.1	1.86	-147.2	0.130	-165.2	0.593	-92.0
8900	0.520	-108.2	1.80	-143.7	0.128	-163.0	0.595	-94.5
9000	0.521	-111.5	1.75	-140.2	0.126	-160.5	0.597	-97.2
9100	0.522	-115.0	1.70	-136.7	0.124	-158.3	0.598	-99.8
9200	0.526	-118.5	1.65	-133.2	0.122	-155.8	0.600	-102.3
9300	0.528	-121.6	1.59	-129.7	0.120	-153.5	0.600	-105.0
9400	0.529	-124.5	1.55	-126.3	0.118	-151.4	0.600	-107.6
9500	0.527	-127.6	1.50	-122.9	0.116	-149.3	0.598	-109.9
9600	0.524	-130.9	1.46	-119.5	0.114	-147.1	0.597	-112.3
9700	0.523	-134.3	1.41	-116.1	0.112	-144.9	0.598	-114.6
9800	0.523	-137.4	1.37	-112.8	0.110	-143.0	0.599	-116.9
9900	0.522	-140.1	1.33	-109.7	0.108	-141.0	0.598	-119.2
10000	0.517	-142.8	1.29	-106.4	0.106	-139.1	0.598	-121.3

S-Parameter Data Files are available on-line at: www.mimixbroadband.com

Mimix Broadband, Inc., 10795 Rockley Rd., Houston, Texas 77099
Tel: 281.988.4600 Fax: 281.988.4615 mimixbroadband.com

Page 5 of 7

Characteristic Data and Specifications are subject to change without notice. ©2006 Mimix Broadband, Inc.
Export of this item may require appropriate export licensing from the U.S. Government. In purchasing these parts, U.S. Domestic customers accept their obligation to be compliant with U.S. Export Laws.

DC-6.0 GHz InGaP HBT, MMIC or Packaged, Matched Gain Block Amplifier

May 2006 - Rev 23-May-06

CGB7007-SC (-BD)
RoHS

Application Circuit

Note: This schematic represents the topology of the application circuit recommended by Mimix.

Recommended Bias Resistor Values for ID = 63 mA				
Supply Voltage (V)	7V	8V	10V	12V
Rbias (R1 Description: 1206 1/4W 1%)	32Ω	47Ω	—	—
Rbias (R1 Description: 1210 1/2W 1%)	—	—	82Ω	110Ω

Note: Rbias provides DC bias stability over temperature.

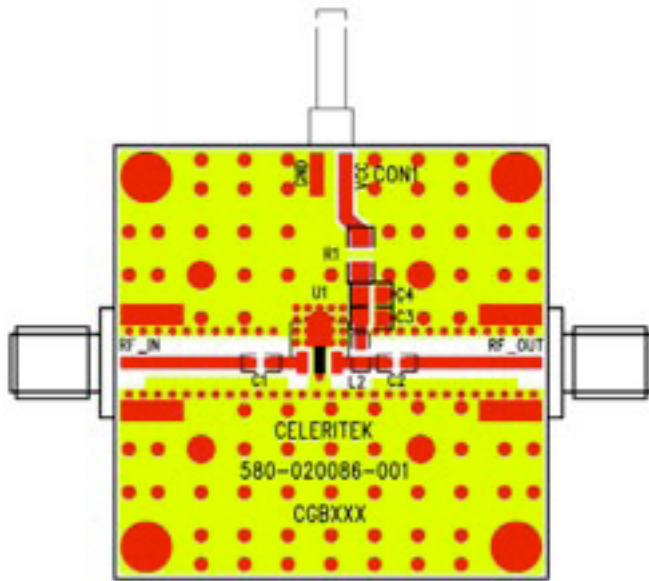
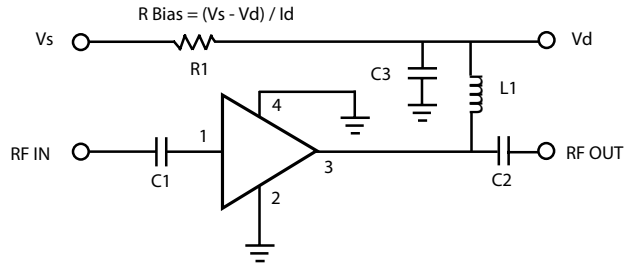

Ref Designator	Value	Description	Size
C1, C2	1000 pF	MCH185A101JK	0805
C3	1.0 μF	VITR 1.0 μF 25V CER CAP 0805 X7R 10%	0805
L1	56 nH	Coilcraft 0603 CS 10%	0603
R1		R Bias = (Vs - Vd) / Id	1206 / 1210
C4		DNP (Do Not Place)	N/A

DC-6.0 GHz InGaP HBT, MMIC or Packaged, Matched Gain Block Amplifier



May 2006 - Rev 23-May-06

CGB7007-SC (-BD)
RoHS

Physical Dimensions - SC Package (SOT-89)

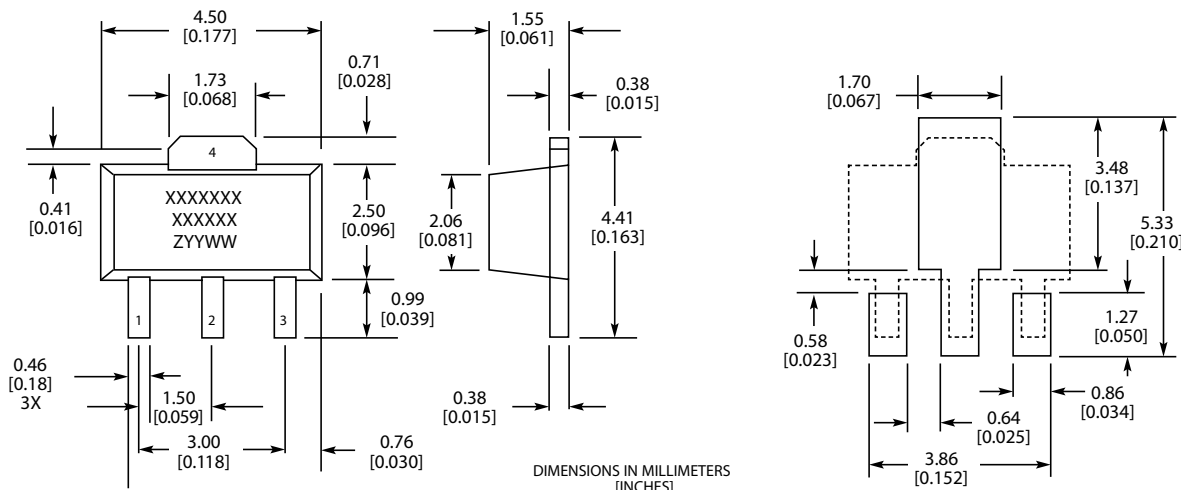

MARKINGS:
 XXXXXXX = MIMIX MODEL NO.
 XXXXXX = WAFER LOT NO.
 ZYYWW = DATE CODE (YR/WEEK)
 FIRST LETTER COUNTRY OF ORIGIN IF OTHER THAN USA

Physical Dimensions - BD (Bare Die)

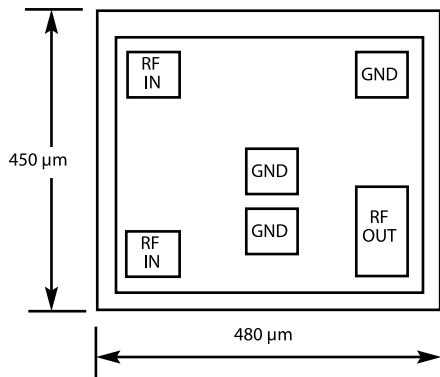

Notes:
 RF OUT bonding pad is 75 μm x 155 μm.
 All other pads are 75 μm x 75 μm.



Ordering Information

Part Number for Ordering	Description
CGB7007-BD	Bare die in GelPak
CGB7007-SC-0G00	Matte Tin plated RoHS compliant SOT-89 surface mount package in bulk quantity
CGB7007-SC-0G0T	Matte Tin plated RoHS compliant SOT-89 surface mount package in tape and reel
CGB7007-SP-0G00	Matte Tin plated RoHS compliant SOT-86 surface mount package in bulk quantity
CGB7007-SP-0G0T	Matte Tin plated RoHS compliant SOT-86 surface mount package in tape and reel
PB-CGB7007-SC-0000	Evaluation Board for SOT-89 packaged device with SMA connectors
PB-CGB7007-SP-0000	Evaluation Board for SOT-86 packaged device with SMA connectors

We also offer the plastic packages with SnPb (Tin-Lead) or NiPdAu plating. Please contact your regional sales manager for more information regarding different plating types

Mimix Broadband, Inc., 10795 Rockley Rd., Houston, Texas 77099
 Tel: 281.988.4600 Fax: 281.988.4615 mimixbroadband.com

Page 7 of 7

Characteristic Data and Specifications are subject to change without notice. ©2006 Mimix Broadband, Inc.
 Export of this item may require appropriate export licensing from the U.S. Government. In purchasing these parts, U.S. Domestic customers accept their obligation to be compliant with U.S. Export Laws.