

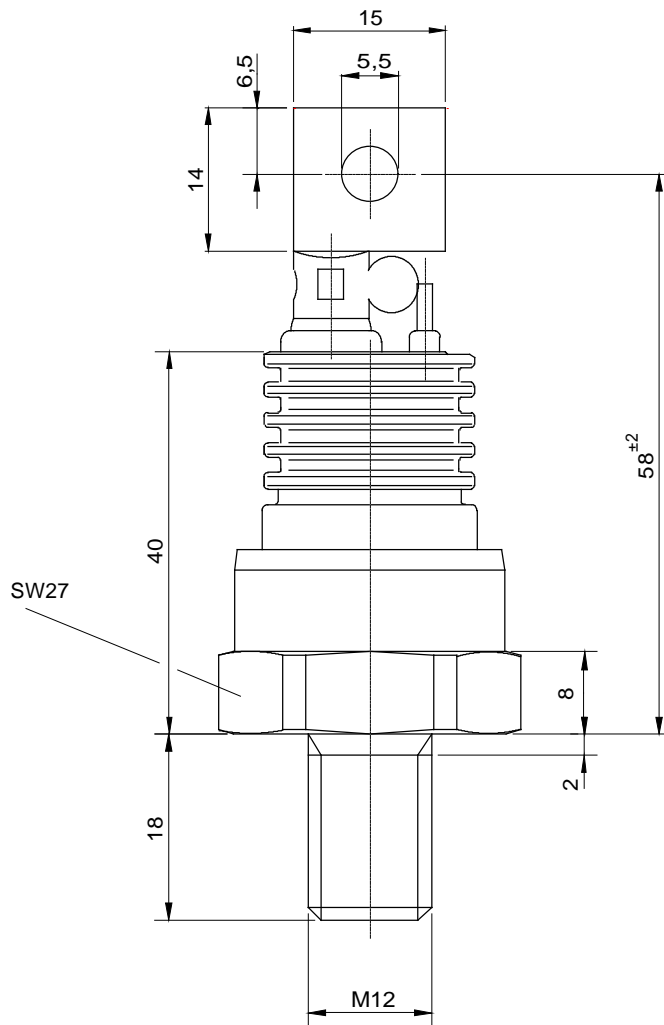

European Power-Semiconductor and Electronics Company GmbH + Co. KG

Leistungsgleichrichterdioden Power Rectifier Diodes D 126 A



Typ	Schalt-symbol	Kathode	Anode
D126A		Anschluß-lasche	Gehäuse-boden
D126B		Gehäuse-boden	Anschluß-lasche

D 126 A 45

Elektrische Eigenschaften

Electrical properties

Höchstzulässige Werte

Maximum rated values

Periodische Spitzensperrspannung	repetitive peak reverse voltage	$t_{vj} = -40^{\circ}\text{C} \dots t_{vj \text{ max}}$	V_{RRM}	4500	V
Stoßsperrverlustleistung	surge reverse power dissipation	$t_{vj} = 25^{\circ}\text{C}, t_w = 20 \mu\text{s}$	P_{RSM}	10	kW
Durchlaßstrom-Grenzeffektivwert	RMS forward current		I_{FRMSM}	315	A
Dauergrenzstrom	mean forward current	$t_c = 100^{\circ}\text{C}$	I_{FAVM}	126	A
		$t_c = 35^{\circ}\text{C}$		200	A
Stoßstrom-Grenzwert	surge forward current	$t_{vj} = 25^{\circ}\text{C}, t_p = 10 \text{ ms}$	I_{FSM}	2,95	kA
		$t_{vj} = t_{vj \text{ max}}, t_p = 10 \text{ ms}$		2,3	kA
Grenzlastintegral	$I^2 t$ -value	$t_{vj} = 25^{\circ}\text{C}, t_p = 10 \text{ ms}$	$I^2 t$	43,5	kA^2s
		$t_{vj} = t_{vj \text{ max}}, t_p = 10 \text{ ms}$		26,45	kA^2s

Charakteristische Werte

Characteristic values

Durchlaßspannung	on-state voltage	$t_{vj} = t_{vj \text{ max}}, i_F = 600 \text{ A}$	V_T	max.	2,8	V
Schleusenspannung	threshold voltage	$t_{vj} = t_{vj \text{ max}}$	$V_{T(TO)}$		0,86	V
Ersatzwiderstand	slope resistance	$t_{vj} = t_{vj \text{ max}}$	r_T		3,2	$\text{m}\Omega$
Sperrstrom	reverse current	$t_{vj} = t_{vj \text{ max}}, V_R = V_{RRM}$	i_R	max.	30	mA
Durchbruchspannung	breakdown voltage	$t_{vj} = +25^{\circ}\text{C} \dots t_{vj \text{ max}}$	$V_{(BR)}$	min.	4,8	kV

Thermische Eigenschaften

Thermal properties

Innerer Widerstand	thermal resistance, junction	$\Theta = 180^{\circ} \text{ sin}$	R_{thJC}	max.	0,257	$^{\circ}\text{C}/\text{W}$
	to case	DC		max.	0,250	$^{\circ}\text{C}/\text{W}$
Übergangs-Wärmewiderstand	thermal resistance, case to heatsink		R_{thCK}	max.	0,04	$^{\circ}\text{C}/\text{W}$
Höchstzul. Sperrschichttemperatur	max. junction temperature		$t_{vj \text{ max}}$		160	$^{\circ}\text{C}$
Betriebstemperatur	operating temperature		$t_{c \text{ op}}$		-40...+160	$^{\circ}\text{C}$
Lagertemperatur	storage temperature		t_{stg}		-40...+160	$^{\circ}\text{C}$

Mechanische Eigenschaften

Mechanical properties

Si-Element mit Druckkontakt	Si-pellet with pressure contact	$\varnothing = 21 \text{ mm}$				
Anzugsdrehmoment	tightening torque	Gehäuseform/case design C	M		20	Nm
Gewicht	weight		G	typ.	110	g
Kriechstrecke	creepage distance				25	mm
Feuchtekategorie	humidity classification	DIN 40040				C
Schwingfestigkeit	vibration resistance	$f = 50 \text{ Hz}$			50	m/s^2
Maßbild	outline					Seite/page
Polarität	polarity					Anode=Gehäuse/case

D 126 A

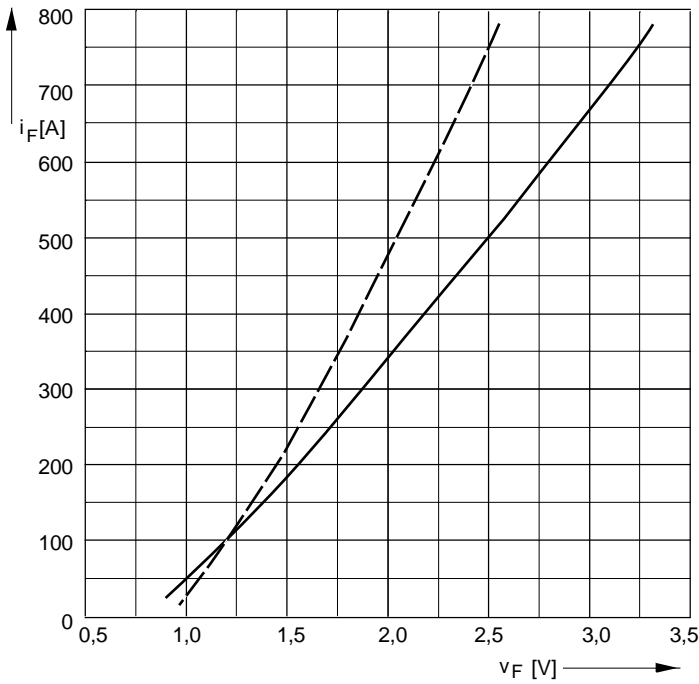

D126A_1

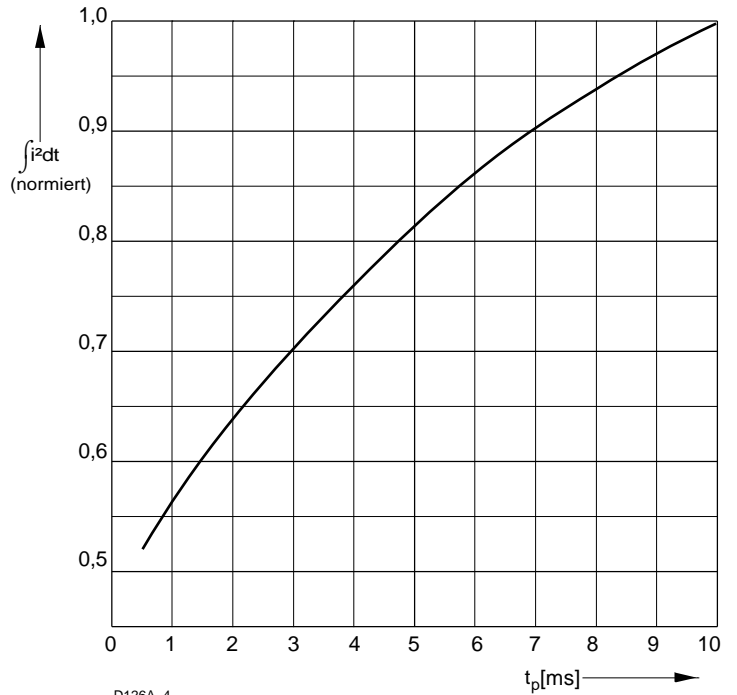

D126A_4

Bild / Fig. 1
 Grenzdurchlaßkennlinie
 Limiting forward characteristic $i_F = f(v_F)$
 — $t_{vj} = 160\text{ °C}$
 - - - $t_{vj} = 25\text{ °C}$

Bild / Fig. 2
 Normiertes Grenzlastintegral / Normalized i^2t
 $\int i^2 dt = f(t_p)$

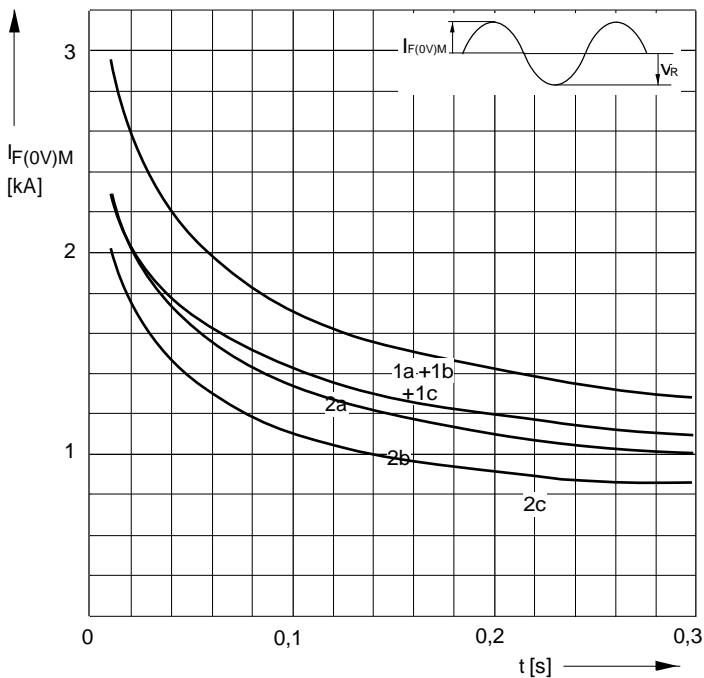

D126A_5

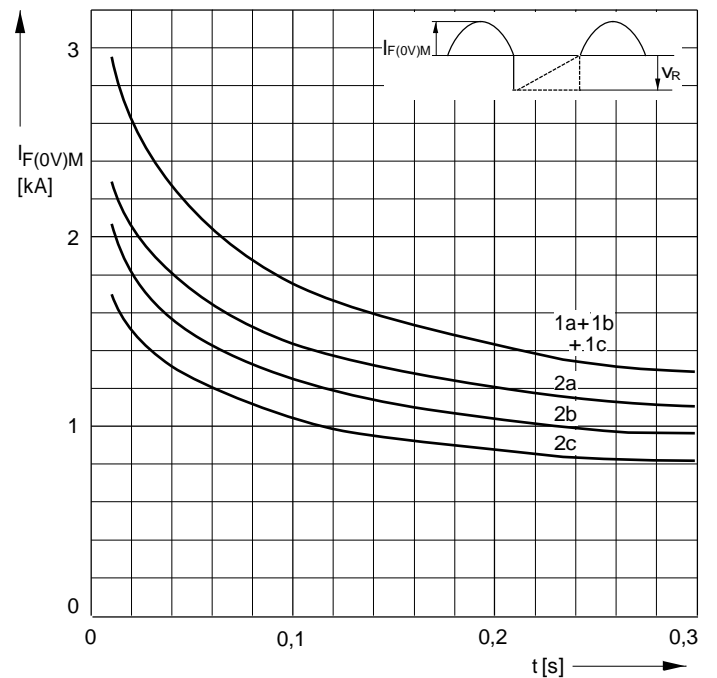

D126A_6

Bild / Fig. 3
 Grenzstrom / Maximum overload forward current $I_{F(0V)M} = f(t)$
 1 - $I_{FAV(vor)} = 0\text{ A}$; $t_{vj} = t_c = 25\text{ °C}$
 2 - $I_{FAV(vor)} = 126\text{ A}$; $t_c = 100\text{ °C}$; $t_{vj} = 160\text{ °C}$
 a - $v_R \leq 50\text{ V}$
 b - $v_R = 0,5\text{ V}_{RRM}$
 c - $v_R = 0,8\text{ V}_{RRM}$

Bild / Fig. 4
 Grenzstrom / Maximum overload forward current $I_{F(0V)M} = f(t)$
 1 - $I_{FAV(vor)} = 0\text{ A}$; $t_{vj} = t_c = 25\text{ °C}$
 2 - $I_{FAV(vor)} = 126\text{ A}$; $t_c = 100\text{ °C}$; $t_{vj} = 160\text{ °C}$
 a - $v_R \leq 50\text{ V}$
 b - $v_R = 0,5\text{ V}_{RRM}$
 c - $v_R = 0,8\text{ V}_{RRM}$

D 126 A



Bild / Fig. 5
 Differenz zwischen den Wärmewiderständen für Pulsstrom und DC
 Difference between the values of thermal resistance for pulse current and DC
 Parameter: Stromkurvenform / Current waveform



Bild / Fig. 6
 Sperrverzögerungsladung / Recovered charge $Q_r = f(-di_F/dt)$
 $t_{vj} = t_{vjmax}$; $V_R \leq 0,5 V_{RRM}$; $V_{RM} = 0,8 V_{RRM}$
 Beschaltung / Snubber: $C = 0,47 \mu F$; $R = 8,2 \Omega$
 Parameter: Durchlaßstrom / Forward current i_{FM}

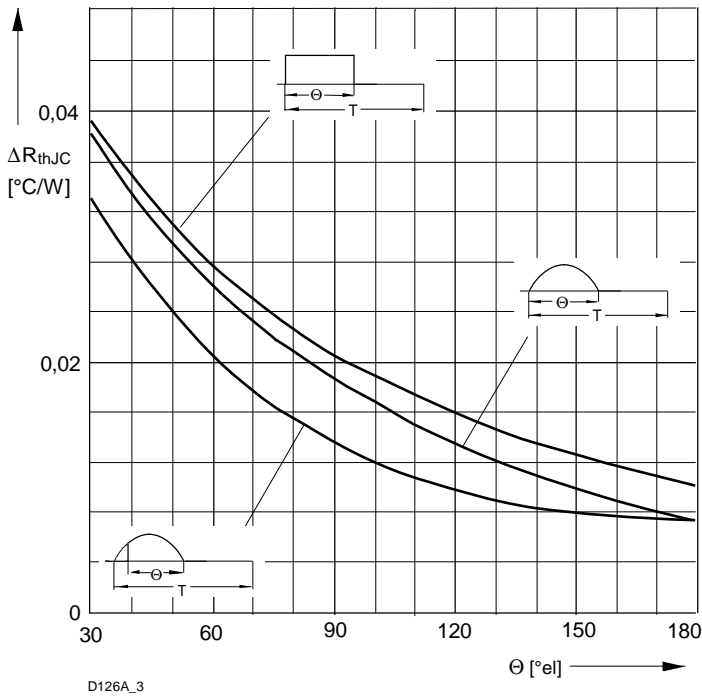

Bild / Fig. 7
 Transienter innerer Wärmewiderstand
 Transient thermal impedance $Z_{thJC} = f(t)$, DC
 1 - Beidseitige Kühlung / Two-sided cooling
 2 - Anodenseitige Kühlung / Anode-sided cooling
 3 - Kathodenseitige Kühlung / Cathode-sided cooling

Analytische Elemente des transienten Wärmewiderstandes Z_{thJC} für DC
 Analytical elements of transient thermal impedance Z_{thJC} for DC

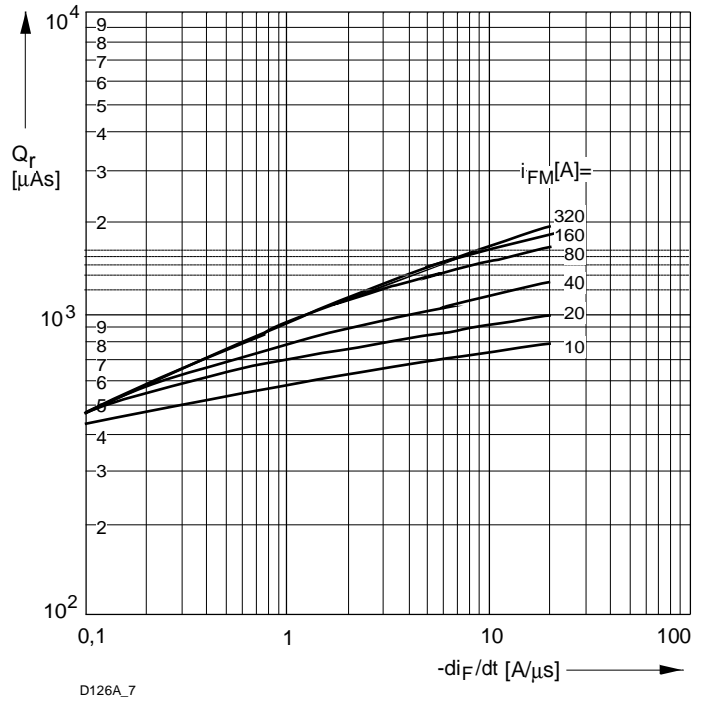
Pos. n	1	2	3	4	5	6	7
$R_{thn} \text{ } ^\circ\text{C/W}$	0,000058	0,003682	0,00761	0,0469	0,134	0,05775	
$t_n \text{ [s]}$	0,000167	0,00154	0,0102	0,162	0,592	4,09	

Analytische Funktion / Analytical function:

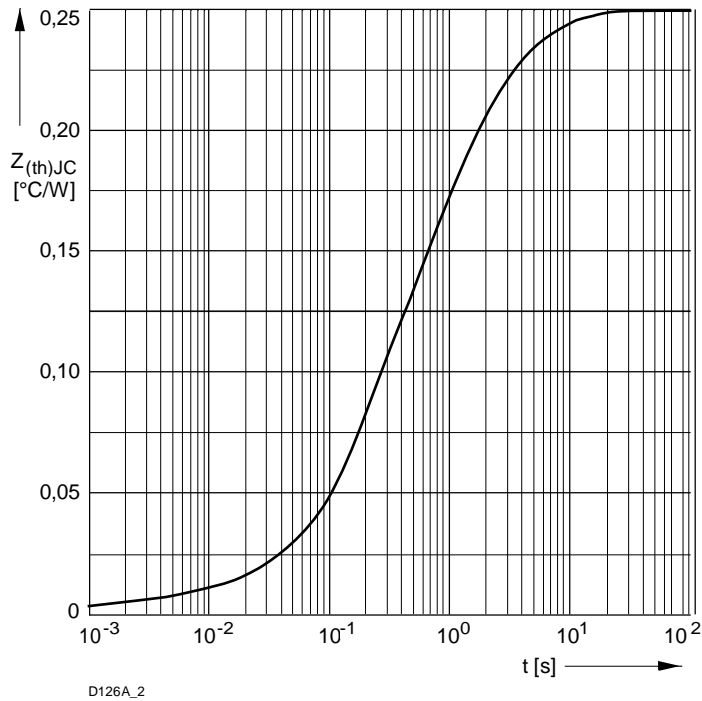
$$Z_{thJC} = \sum_{n=1}^{n_{max}} R_{thn}(1-EXP(-t/\tau_n))$$