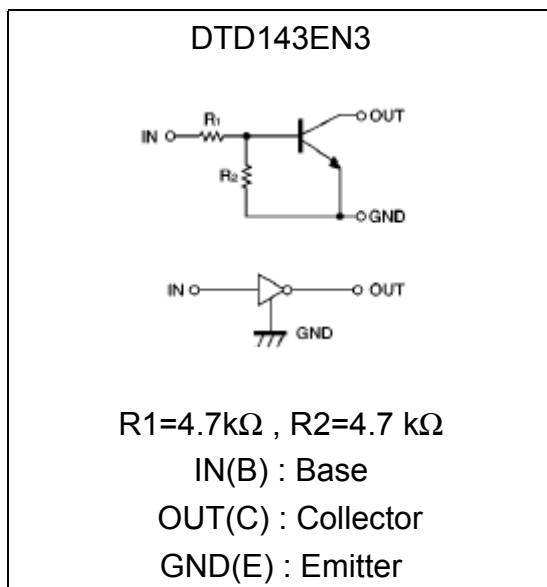
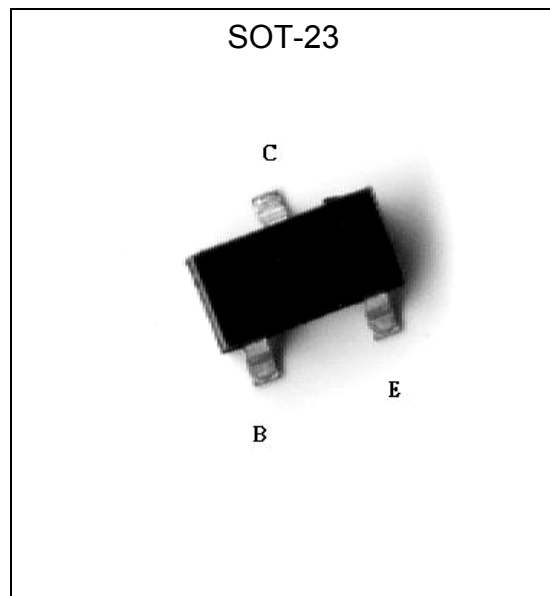

**NPN Digital Transistors (Built-in Resistors)**

# DTD143EN3

**Features**

- Built-in bias resistors enable the configuration of an inverter circuit without connecting external input resistors (see equivalent circuit).
- The bias resistors consist of thin-film resistors with complete isolation to allow negative biasing of the input. They also have the advantage of almost completely eliminating parasitic effects.
- Only the on/off conditions need to be set for operation, making device design easy.
- Complements the DTB143EN3

**Equivalent Circuit**

**Outline**

**Absolute Maximum Ratings (Ta=25°C)**

Parameter	Symbol	Limits	Unit
Supply Voltage	V <sub>CC</sub>	50	V
Input Voltage	V <sub>IN</sub>	-10~+30	V
Output Current	I <sub>o</sub>	500	mA
Power Dissipation	P <sub>d</sub>	200	mW
Junction Temperature	T <sub>j</sub>	150	°C
Storage Temperature	T <sub>stg</sub>	-55~+150	°C



**Characteristics (Ta=25°C)**

Parameter	Symbol	Min.	Typ.	Max.	Unit	Test Conditions
Input Voltage	$V_{I(off)}$	-	-	0.5	V	$V_{CC}=5V, I_o=100\mu A$
	$V_{I(on)}$	3	-	-	V	$V_o=0.3V, I_o=20mA$
Output Voltage	$V_{O(on)}$	-	0.1	0.3	V	$I_o/I_i=50mA/2.5mA$
Input Current	$I_i$	-	-	1.8	mA	$V_i=5V$
Output Current	$I_{O(off)}$	-	-	0.5	$\mu A$	$V_{CC}=50V, V_i=0V$
DC Current Gain	$G_i$	47	-	-	-	$V_o=5V, I_o=50mA$
Input Resistance	$R_i$	3.29	4.7	6.11	k $\Omega$	-
Resistance Ratio	$R_2/R_1$	0.8	1	1.2	-	-
Transition Frequency	$f_T$	-	200	-	MHz	$V_{CE}=10V, I_c=50\mu A, f=100MHz$ *

\* Transition frequency of the device



### Characteristic Curves

Current Gain vs Output Current

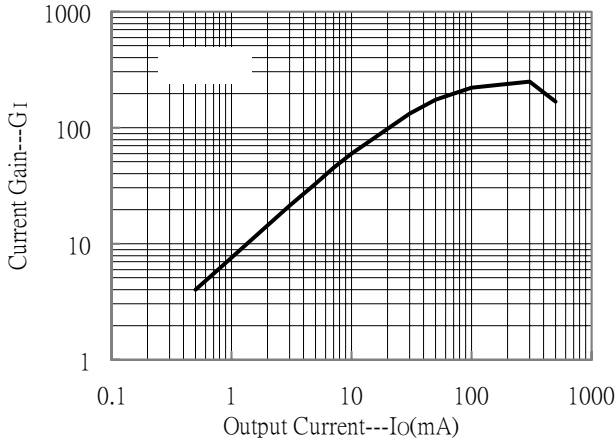

Output Voltage vs Output Current

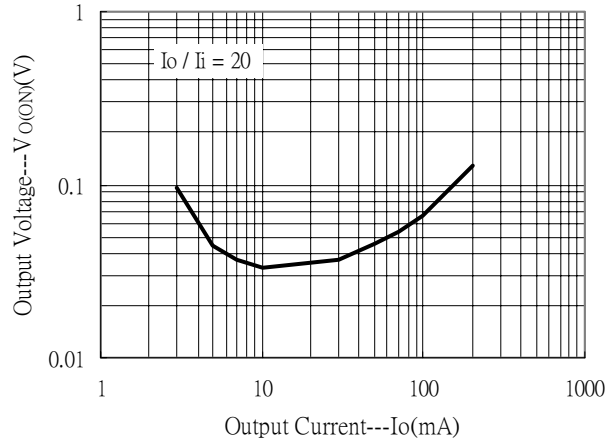

Input Voltage vs Output Current(ON characteristics)

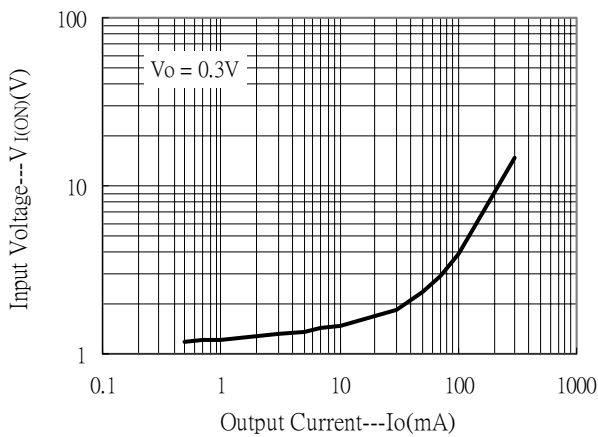

Output Current vs Input Voltage(OFF characteristics)

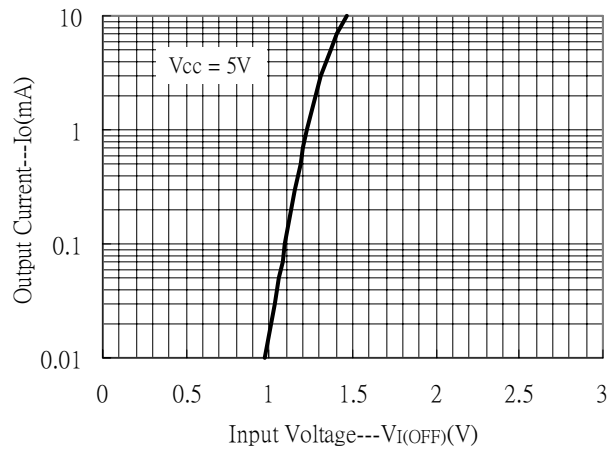

Power Derating Curve

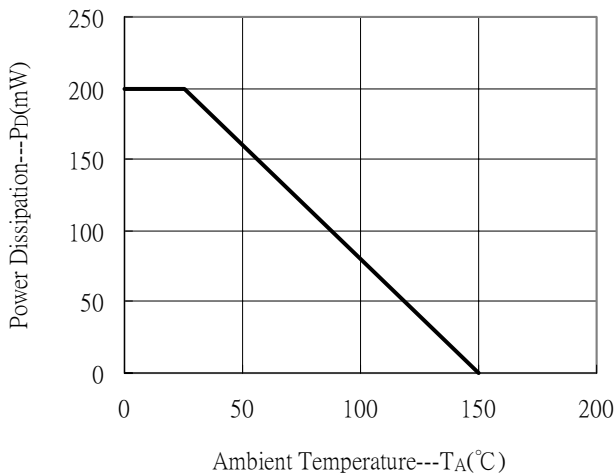

**SOT-23 Dimension**

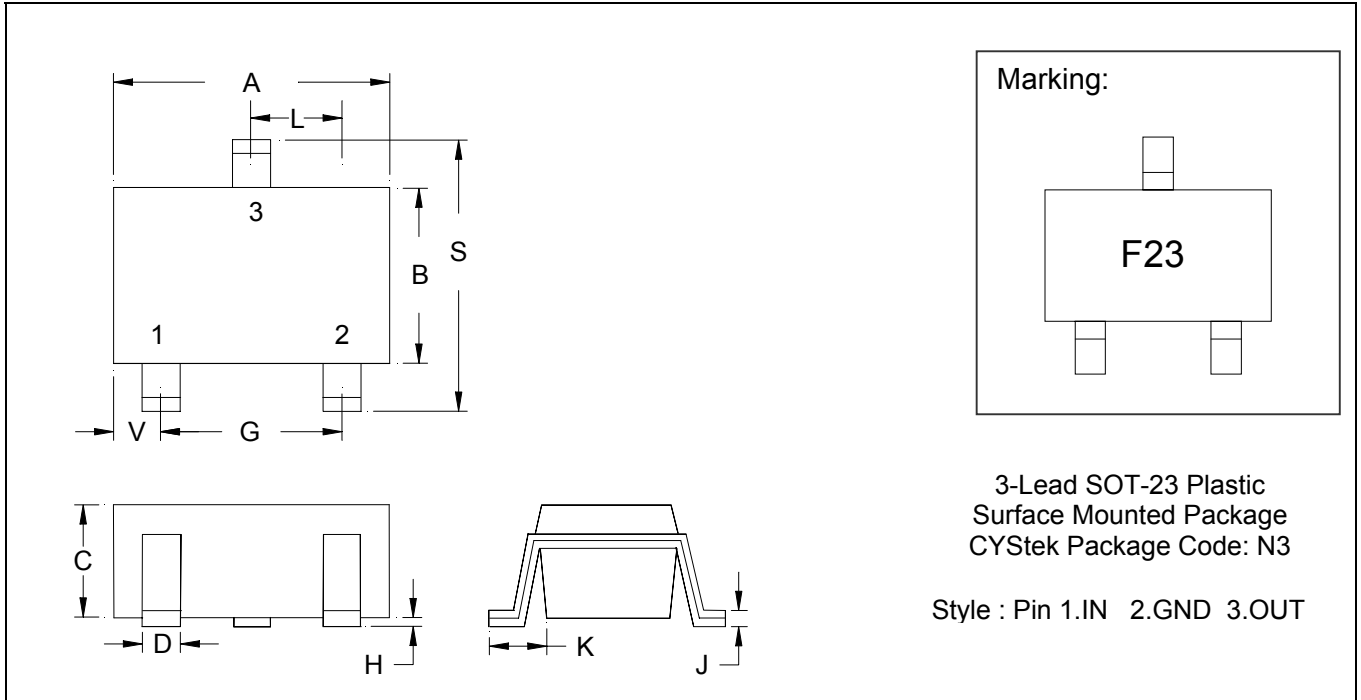

\*:Typical

DIM	Inches		Millimeters		DIM	Inches		Millimeters	
	Min.	Max.	Min.	Max.		Min.	Max.	Min.	Max.
A	0.1102	0.1204	2.80	3.04	J	0.0034	0.0070	0.085	0.177
B	0.0472	0.0630	1.20	1.60	K	0.0128	0.0266	0.32	0.67
C	0.0335	0.0512	0.89	1.30	L	0.0335	0.0453	0.85	1.15
D	0.0118	0.0197	0.30	0.50	S	0.0830	0.1083	2.10	2.75
G	0.0669	0.0910	1.70	2.30	V	0.0098	0.0256	0.25	0.65
H	0.0005	0.0040	0.013	0.10					

- Notes :**
- 1.Controlling dimension : millimeters.
  - 2.Maximum lead thickness includes lead finish thickness, and minimum lead thickness is the minimum thickness of base material.
  - 3.If there is any question with packing specification or packing method, please contact your local CYStek sales office.

**Material :**

- Lead : 42 Alloy ; solder plating
- Mold Compound : Epoxy resin family, flammability solid burning class:UL94V-0

**Important Notice:**

- All rights are reserved. Reproduction in whole or in part is prohibited without the prior written approval of CYStek.
- CYStek reserves the right to make changes to its products without notice.
- CYStek **semiconductor products are not warranted to be suitable for use in Life-Support Applications, or systems.**
- CYStek assumes no liability for any consequence of customer product design, infringement of patents, or application assistance.