

AH312 / ECP200G

2 Watt, High Linearity InGaP HBT Amplifier

Product Information



Product Features

- 400 – 2300 MHz
- +33 dBm P1dB
- +51 dBm Output IP3
- 18 dB Gain @ 900 MHz
- 11 dB Gain @ 1960 MHz
- Single Positive Supply (+5V)
- Lead-free/green/RoHS-compliant SOIC-8 SMT Pkg.

Applications

- Final stage amplifiers for Repeaters
- Mobile Infrastructure
- Defense / Homeland Security

Product Description

The AH312 / ECP200 is a high dynamic range driver amplifier in a low-cost surface mount package. The InGaP/GaAs HBT is able to achieve high performance for various narrowband-tuned application circuits with up to +49 dBm OIP3 and +33 dBm of compressed 1dB power. It is housed in a lead-free/green/RoHS-compliant SOIC-8 package. All devices are 100% RF and DC tested.

The AH312 / ECP200 is targeted for use as a driver amplifier in wireless infrastructure where high linearity and medium power is required. An internal active bias allows the AH312 to maintain high linearity over temperature and operate directly off a single +5V supply. This combination makes the device an excellent candidate for transceiver line cards in current and next generation multi-carrier 3G base stations.

Functional Diagram

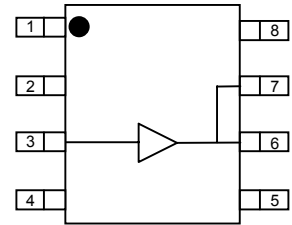

Function	Pin No.
Vref	1
Input	3
Output	6, 7
Vbias	8
GND	Backside Paddle
N/C or GND	2, 4, 5

Specifications ⁽¹⁾

Parameter	Units	Min	Typ	Max
Operational Bandwidth	MHz	400		2300
Test Frequency	MHz		2140	
Gain	dB	9	10	
Input R.L.	dB		20	
Output R.L.	dB		6.8	
Output P1dB	dBm	+32	+33.2	
Output IP3 ⁽²⁾	dBm	+47	+48	
IS-95A Channel Power @ -45 dBc ACPR, 1960 MHz	dBm		+27.5	
W-CDMA Channel Power @ -45 dBc ACLR, 2140 MHz	dBm		+25.3	
Noise Figure	dB		7.7	
Operating Current Range, Icc ⁽³⁾	mA	700	800	900
Device Voltage, Vcc	V		+5	

1. Test conditions unless otherwise noted: 25°C, +5V Vsupply, 2140 MHz, in tuned application circuit.
2. 3OIP measured with two tones at an output power of +17 dBm/tone separated by 1 MHz. The suppression on the largest IM3 product is used to calculate the 3OIP using a 2:1 rule.
3. This corresponds to the quiescent current or operating current under small-signal conditions into pins 6, 7, and 8. It is expected that the current can increase by an additional 200 mA at P1dB. Pin 1 is used as a reference voltage for the internal biasing circuitry. It is expected that Pin 1 will pull 22mA of current when used with a series bias resistor of R1=15Ω. (ie. total device current typically will be 822 mA.)

Typical Performance ⁽⁴⁾

Parameter	Units	Typical		
Frequency	MHz	900	1960	2140
S21 – Gain	dB	18	11	10
S11 – Input R.L.	dB	-18	-19	-20
S22 – Output R.L.	dB	-11	-6.8	-6.8
Output P1dB	dBm	+33	+33.4	+33.2
Output IP3	dBm	+49	+51	+48
IS-95A Channel Power @ -45 dBc ACPR	dBm	+27	+27.5	
W-CDMA Channel Power @ -45 dBc ACLR	dBm			+25.3
Noise Figure	dB	8.0	7.3	7.7
Device Bias ⁽³⁾		+5 V @ 800 mA		

4. Typical parameters reflect performance in a tuned application circuit at +25° C.

Absolute Maximum Rating

Parameter	Rating
Operating Case Temperature	-40 to +85 °C
Storage Temperature	-65 to +150 °C
RF Input Power (continuous)	+28 dBm
Device Voltage	+8 V
Device Current	1400 mA
Device Power	8 W
Junction Temperature	+250 °C

Operation of this device above any of these parameters may cause permanent damage.

Ordering Information

Part No.	Description
AH312-S8*	2 Watt, High Linearity InGaP HBT Amplifier (lead-tin SOIC-8 Pkg)
ECP200G*	2 Watt, High Linearity InGaP HBT Amplifier (lead-tin SOIC-8 Pkg)
AH312-S8G	2 Watt, High Linearity InGaP HBT Amplifier (lead-free/green/RoHS-compliant SOIC-8 Pkg)
AH312-S8PCB900	900 MHz Evaluation Board
AH312-S8PCB1960	1960 MHz Evaluation Board
AH312-S8PCB2140	2140 MHz Evaluation Board

* This package is being phased out in favor of the green package type which is backwards compatible for existing designs. Refer to Product Change Notification WJPCN06MAY05TC1 on the WJ website.

Specifications and information are subject to change without notice.

AH312 / ECP200G

2 Watt, High Linearity InGaP HBT Amplifier

Product Information



Typical Device Data

S-Parameters ($V_{CC} = +5\text{ V}$, $I_{CC} = 800\text{ mA}$, $T = 25^\circ\text{C}$, unmatched 50 ohm system)

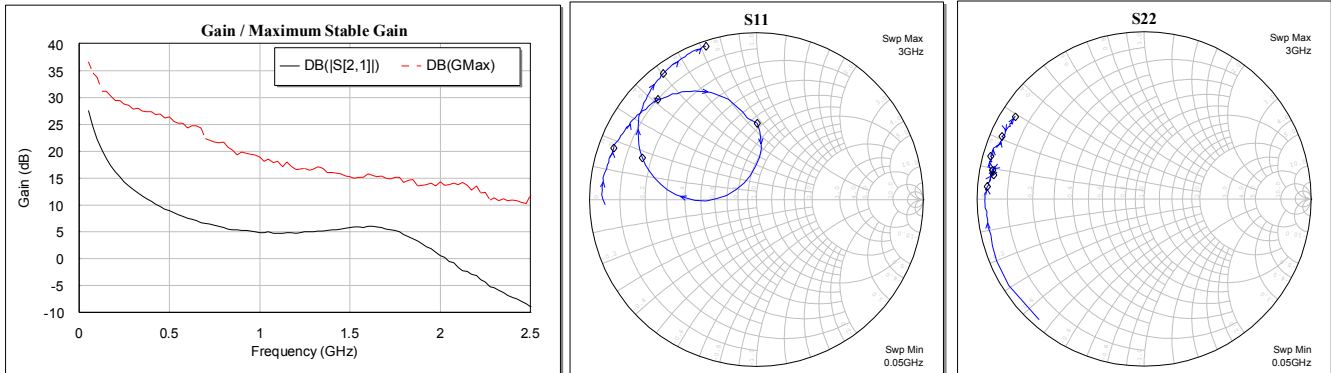

Notes:

The gain for the unmatched device in 50 ohm system is shown as the trace in black color. For a tuned circuit for a particular frequency, it is expected that actual gain will be higher, up to the maximum stable gain. The maximum stable gain is shown in the dashed red line. The impedance plots are shown from 50 – 3000 MHz, with markers placed at 0.5 – 3.0 GHz in 0.5 GHz increments.

S-Parameters ($V_{CC} = +5\text{ V}$, $I_{CC} = 800\text{ mA}$, $T = 25^\circ\text{C}$, unmatched 50 ohm system, calibrated to device leads)

Freq (MHz)	S11 (dB)	S11 (ang)	S21 (dB)	S21 (ang)	S12 (dB)	S12 (ang)	S22 (dB)	S22 (ang)
50	-0.86	-178.06	27.55	113.72	-45.75	30.91	-0.38	-130.98
100	-0.64	178.18	22.16	98.81	-45.46	12.80	-0.38	-157.30
200	-0.68	172.85	16.13	89.06	-42.65	6.09	-0.48	-172.51
400	-0.76	164.33	10.61	77.31	-43.96	4.69	-0.48	177.51
600	-0.93	155.56	7.46	67.94	-41.17	6.70	-0.61	173.63
800	-1.15	146.04	5.78	57.62	-41.65	-5.78	-0.66	170.49
1000	-1.50	134.58	4.87	46.90	-40.36	-7.84	-0.71	169.31
1200	-2.39	121.66	4.74	32.96	-40.22	-16.51	-0.80	168.22
1400	-4.47	104.01	5.33	14.01	-38.97	-48.82	-0.76	167.91
1600	-11.96	86.06	5.96	-17.55	-38.96	-86.32	-0.60	170.63
1800	-8.66	-179.11	4.41	-56.78	-39.35	-144.53	-0.52	167.41
2000	-2.76	159.91	0.53	-89.86	-43.55	145.94	-0.41	164.50
2200	-1.21	142.90	-3.21	-107.99	-41.56	104.25	-0.54	160.11
2400	-0.68	130.93	-7.27	-123.14	-42.46	73.64	-0.68	157.84
2600	-0.43	121.91	-10.41	-134.93	-39.71	64.28	-0.73	154.66
2800	-0.32	114.61	-13.28	-143.22	-40.99	58.20	-0.73	151.14
3000	-0.29	108.16	-15.94	-149.93	-39.65	48.40	-0.79	147.52

Application Circuit PC Board Layout

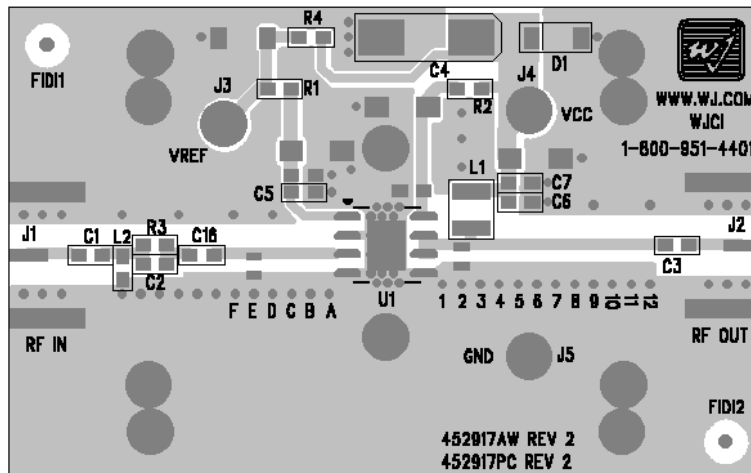

Circuit Board Material: .014" Getek, single layer, 1 oz copper, Microstrip line details: width = .026", spacing = .026"
 The silk screen markers 'A', 'B', 'C', etc. and '1', '2', '3', etc. are used as placemarkers for the input and output tuning shunt capacitors – C8 and C9. The markers and vias are spaced in .050" increments.

Specifications and information are subject to change without notice.

AH312 / ECP200G

2 Watt, High Linearity InGaP HBT Amplifier

Product Information



900 MHz Application Circuit (AH312-S8PCB900)

Typical RF Performance at 25°C

Frequency	900 MHz
S21 – Gain	18 dB
S11 – Input Return Loss	-18 dB
S22 – Output Return Loss	-11 dB
Output P1dB	+33 dBm
Output IP3 (+17 dBm / tone, 1 MHz spacing)	+49 dBm
Channel Power (@-45 dBc ACPR, IS-95 9 channels fwd)	+27 dBm
Noise Figure	8.0 dB
Device / Supply Voltage	+5 V
Quiescent Current ⁽¹⁾	800 mA

1. This corresponds to the quiescent current or operating current under small-signal conditions into pins 6, 7, and 8.

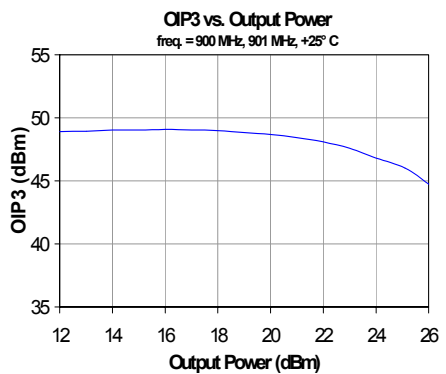
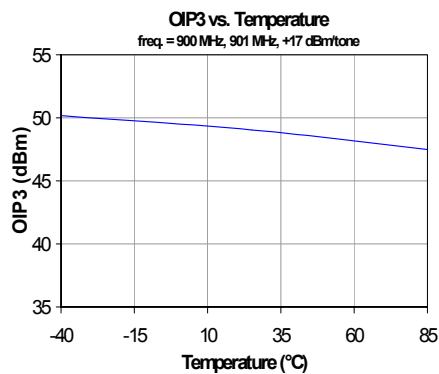
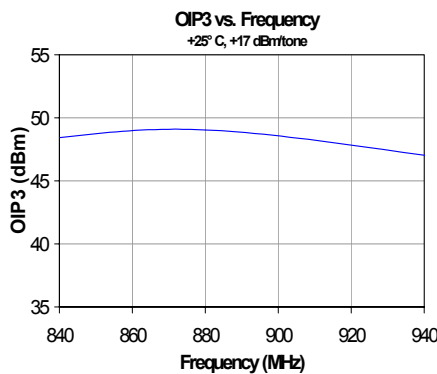
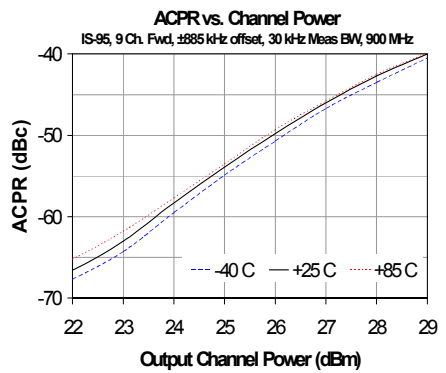
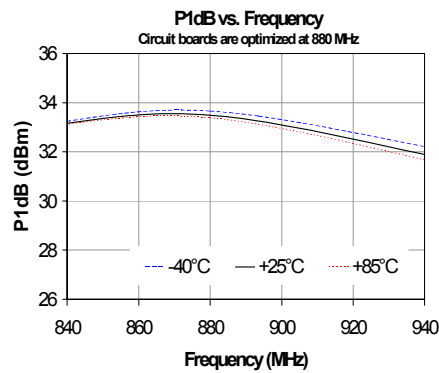
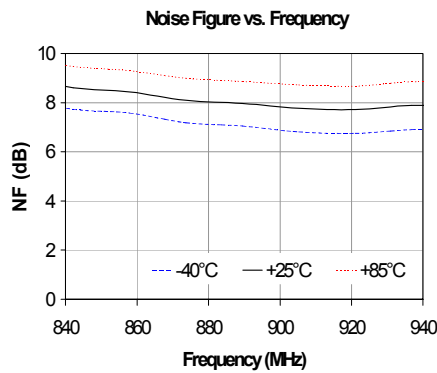
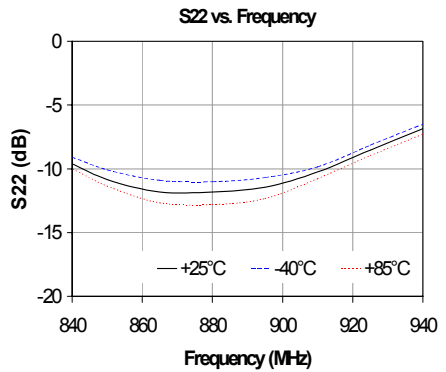
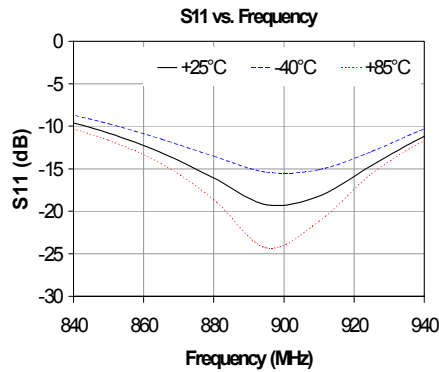
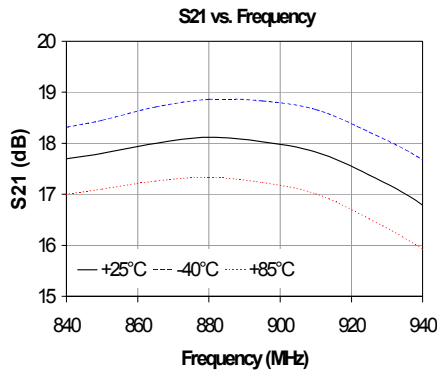
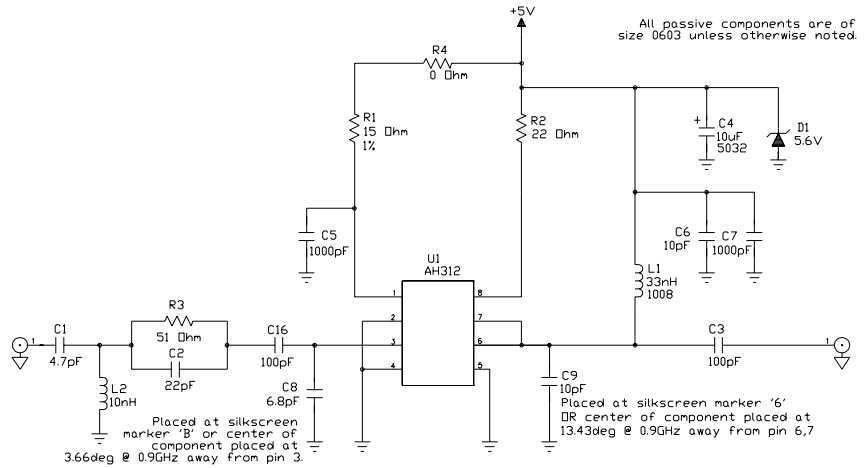

Specifications and information are subject to change without notice.

AH312 / ECP200G

2 Watt, High Linearity InGaP HBT Amplifier

Product Information



1960 MHz Application Circuit (AH312-S8PCB1960)

Typical RF Performance at 25°C

Frequency	1960 MHz
S21 – Gain	11 dB
S11 – Input Return Loss	-20 dB
S22 – Output Return Loss	-6.8 dB
Output P1dB	+33.4 dBm
Output IP3 (+17 dBm/ tone, 1 MHz spacing)	+51 dBm
Channel Power (@-45 dBc ACPR, IS-95 9 channels fwd)	+27.5 dBm
Noise Figure	7.3 dB
Device / Supply Voltage	+5 V
Quiescent Current ⁽¹⁾	800 mA

1. This corresponds to the quiescent current or operating current under small-signal conditions into pins 6, 7, and 8.

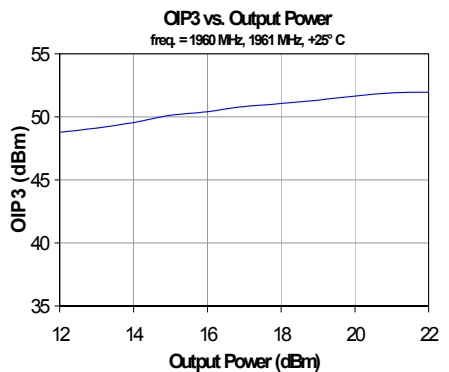
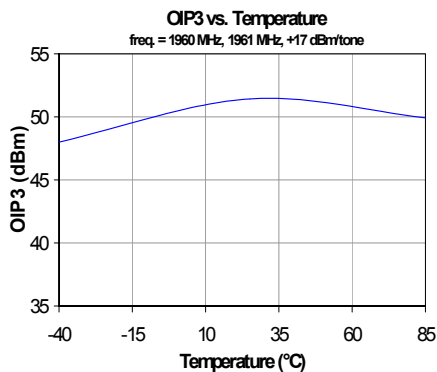
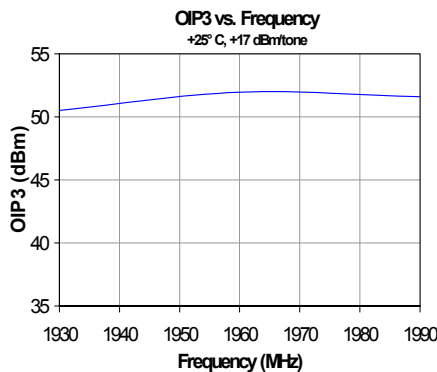
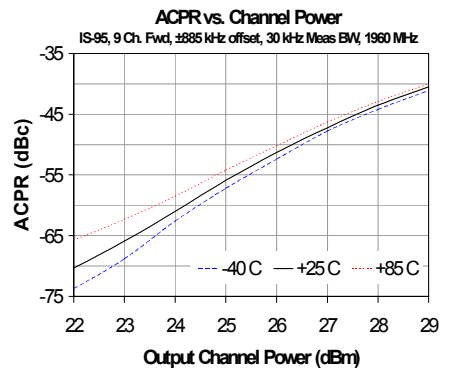
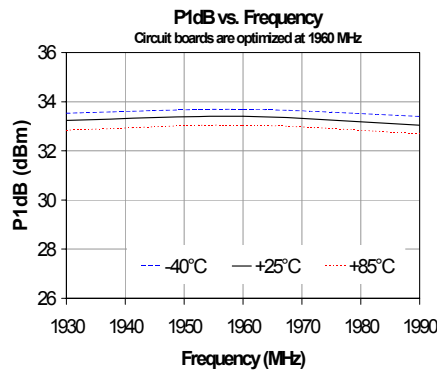
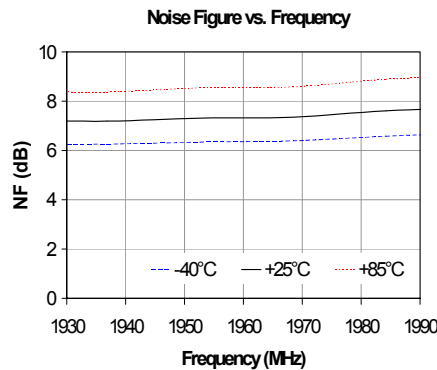
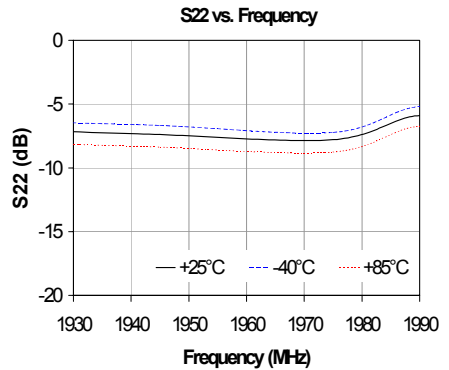
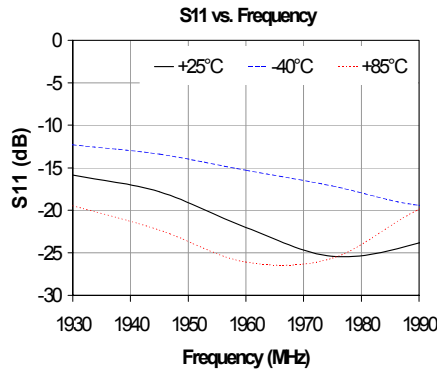
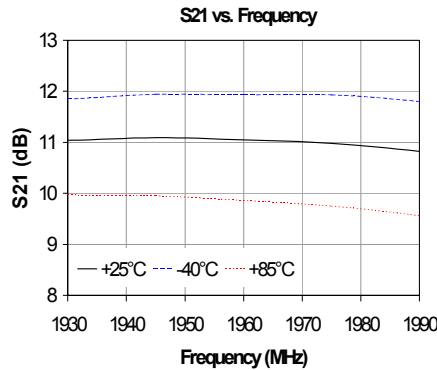
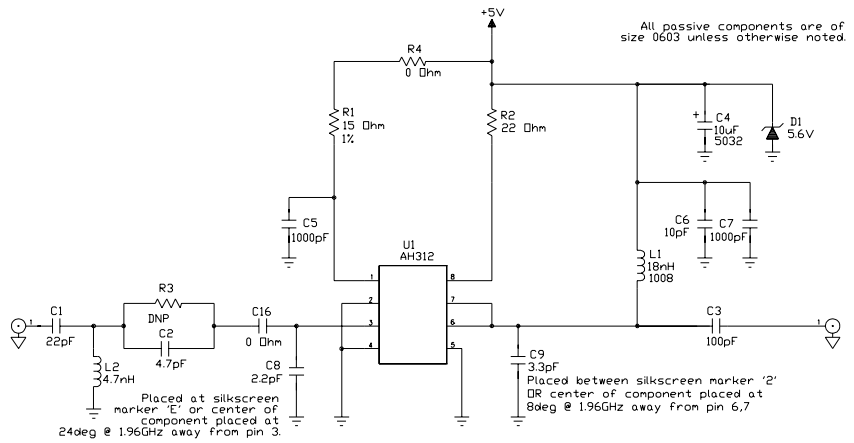

Specifications and information are subject to change without notice.

AH312 / ECP200G

2 Watt, High Linearity InGaP HBT Amplifier

Product Information



2140 MHz Application Circuit (AH312-S8PCB2140)

Typical RF Performance at 25°C

Frequency	2140 MHz
S21 – Gain	10 dB
S11 – Input Return Loss	-20 dB
S22 – Output Return Loss	-6.8 dB
Output P1dB	+33.2 dBm
Output IP3 (+17 dBm/ tone, 1 MHz spacing)	+48 dBm
W-CDMA Channel Power (@ -45 dBc ACLR)	+25.3 dBm
Noise Figure	7.7 dB
Device / Supply Voltage	+5 V
Quiescent Current ⁽¹⁾	800 mA

1. This corresponds to the quiescent current or operating current under small-signal conditions into pins 6, 7, and 8.

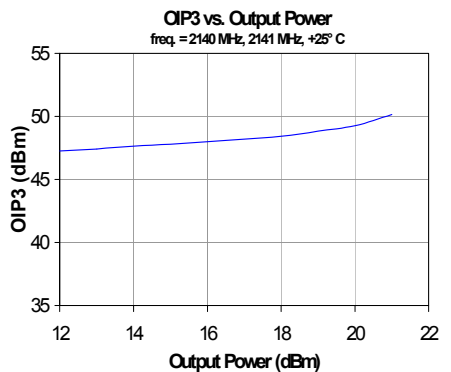
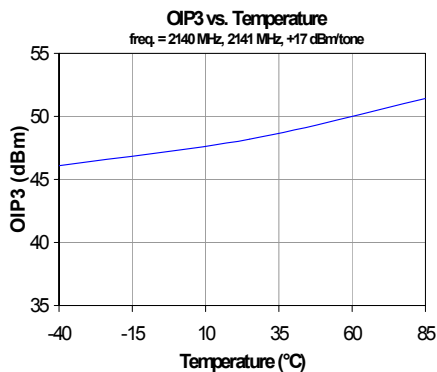
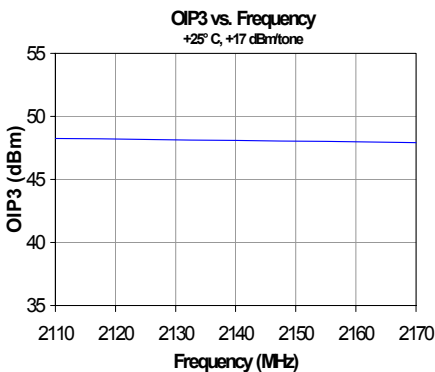
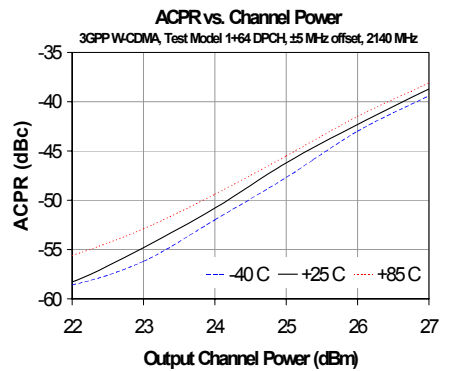
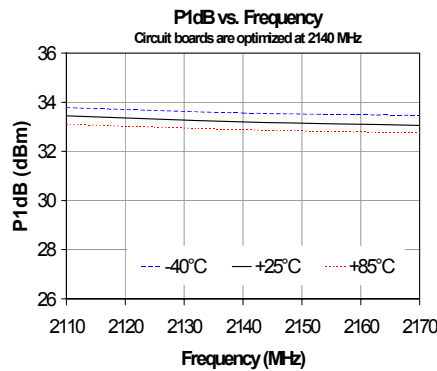
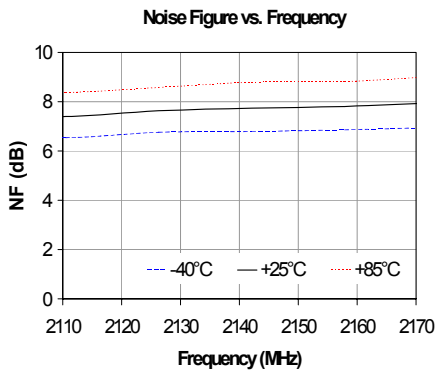
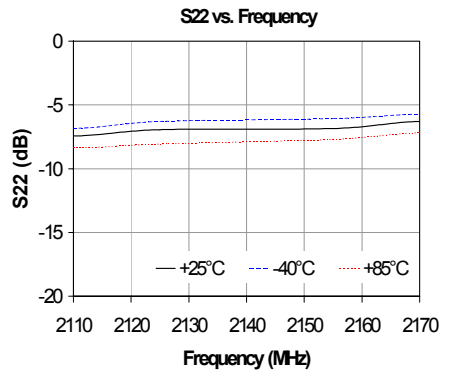
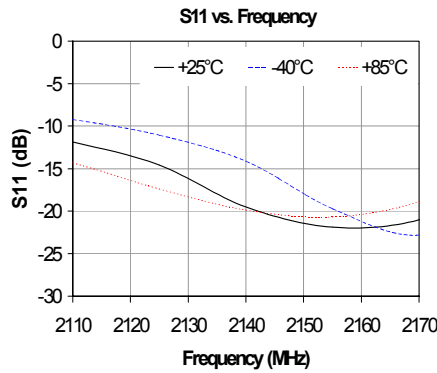
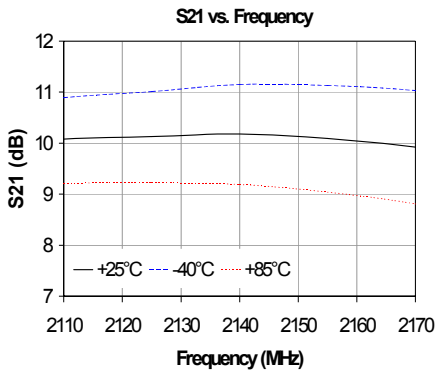
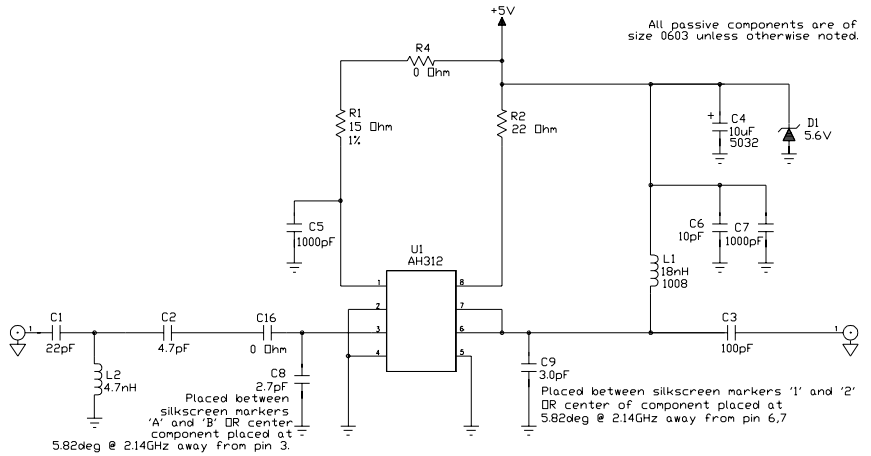

Specifications and information are subject to change without notice.

AH312 / ECP200G

2 Watt, High Linearity InGaP HBT Amplifier

Product Information



Application Note: Reduced Bias Configurations

The AH312 / ECP200 can be configured to be operated with lower bias current by varying the bias-adjust resistor – R1. The recommended circuit configurations shown previously in this datasheet have the device operating in Class A operation. Lowering the current has little effect on the gain, OIP3, and P1dB performance of the device, but will slightly lower the ACLR/ACPR performance of the device as shown below. An example of the measured data below represents the AH312 / ECP200 measured and configured for 2.14 GHz applications. It is expected that variation of the bias current for other frequency applications will produce similar performance results.

AH312-PCB2140 Performance Data

R1 (ohms)	I _{dc} (mA)	P _{diss} (W)	P1dB (dBm)	OIP3 (dBm)
15	800	4.0	+33.3	+51.4
22	700	3.5	+33.3	+50.9
43	600	3.0	+33.1	+50.9
62	500	2.5	+33.0	+50.7
110	400	2.0	+32.9	+47.3

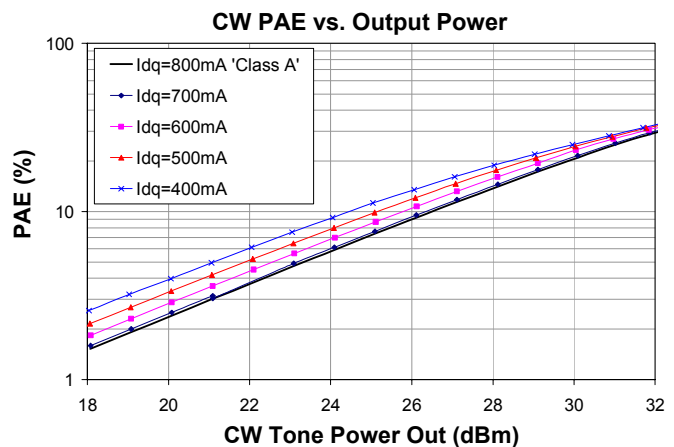
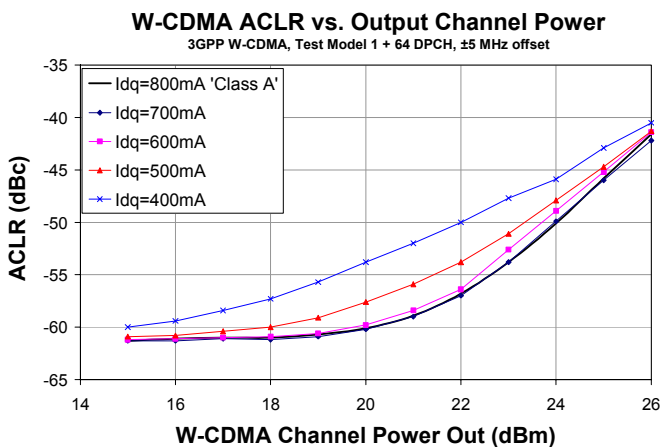
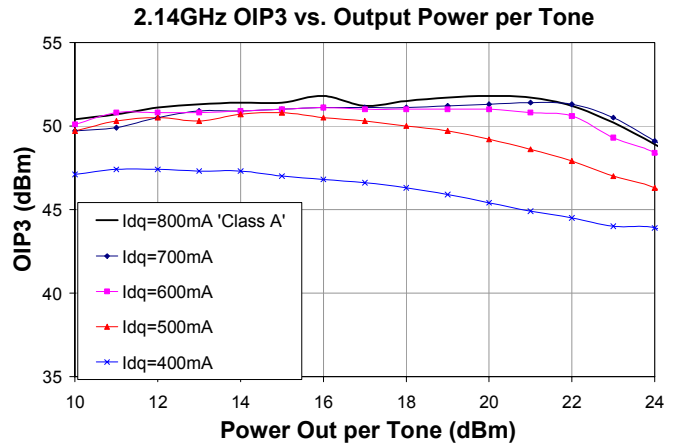
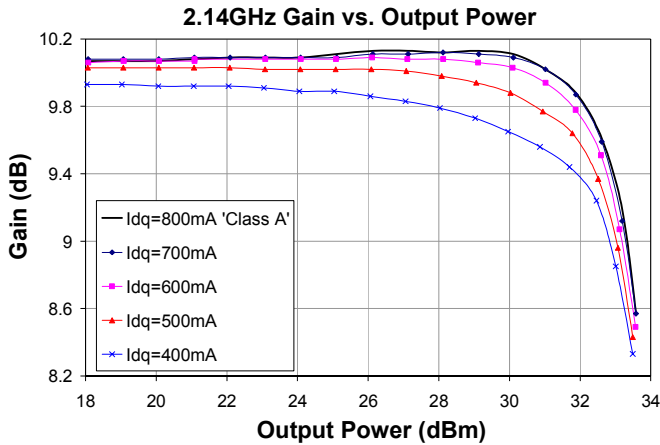
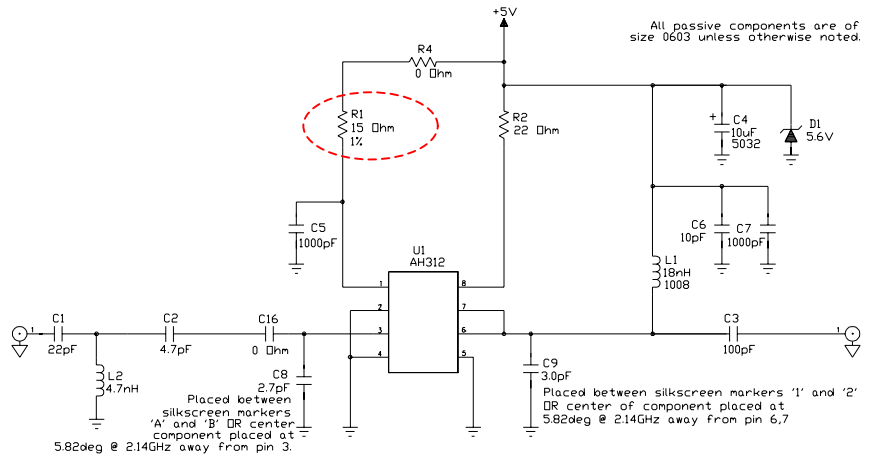

Specifications and information are subject to change without notice.

AH312 / ECP200G

2 Watt, High Linearity InGaP HBT Amplifier

Product Information



AH312-S8 (SOIC-8 Package) Mechanical Information

This package may contain lead-bearing materials. The plating material on the leads is SnPb.

Outline Drawing

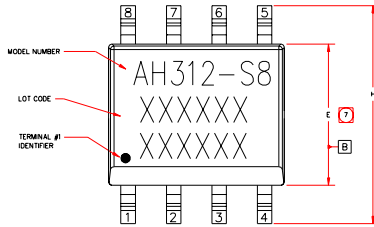

- NOTES:
- EXCEPT WHERE NOTED, THIS PART OUTLINE CONFORMS TO JEDEC STANDARD MS-012 ISSUE C FOR SMALL OUTLINE (SO) PERIPHERAL TERMINALS 3.75mm BODY WIDTH (PLASTIC).
 - DIMENSIONING & TOLERANCING CONFORM TO ASME Y14.4M-1994.
 - ALL DIMENSIONS ARE IN MILLIMETERS. ANGLES ARE IN DEGREES.
 - DOES NOT INCLUDE MOLD FLASH, PROTRUSIONS OR GATE BURRS, WHICH SHALL NOT EXCEED .15mm(.006in) PER SIDE.
 - DEVIATION FROM JEDEC MS-012 STANDARD.
 - LENGTH OF TERMINAL FOR SOLDERING TO A SUBSTRATE.
 - DOES NOT INCLUDE INTER-LEAD FLASH OR PROTRUSIONS, WHICH SHALL NOT EXCEED .25mm(.010in) PER SIDE.

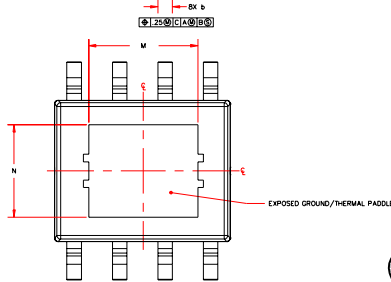
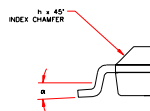
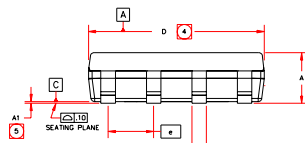

SYMBOL	MILLIMETERS	
	MIN.	MAX.
A	1.30	1.35
A1	0	0.059
D	3.75	3.80
b	.38	.017
C	.16	.009
D	.189	.197
E	1.15	.150
h	.050 BSC	
M	.90	.228
N	.27	.016
s	3.15	.124
5x	2.54	.100
5x	.61	.025

Product Marking

The component will be marked with an "AH312-S8" designator with an alphanumeric lot code on the top surface of the package.

Tap reel specifications for this part are located on the website "Application" section.

ESD, MSL Information

ESD Sensitive device.

- ESD Rating: Class 1B
- Value: Passes between 500 and 1000V
- Test Method: Human Body Model (HBM)
- Standard: JEDEC Standard JESD22-A114
- Thermal Rating: Level 3 at +235°C convection reflow
- Standard: JEDEC Standard J-STD-020

Land Pattern

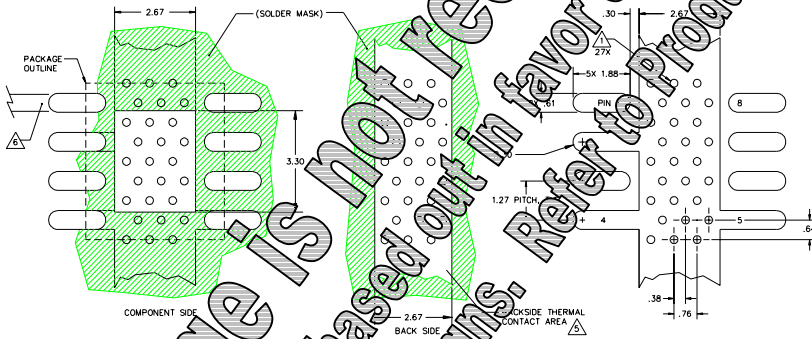

Mounting Config. Notes

- A heatsink underneath the area of the PCB for the mounted device is strictly required for proper thermal operation. Damage to the device can occur without the use of one.
- Ground / thermal vias are critical for the proper performance of this device. Vias should use a .35mm (#80 / .0135") diameter drill and have a final plated thru diameter of .25 mm (.010").
- Add as much copper as possible to inner and outer layers near the part to ensure optimal thermal performance.
- Mounting screws can be added near the part to fasten the board to a heatsink. Ensure that the ground / thermal via region contacts the heatsink.
- Do not put solder mask on the backside of the PC board in the region where the board contacts the heatsink.
- RF trace width depends upon the PC board material and construction.
- Use 1 oz. Copper minimum.
- All dimensions are in millimeters (inches). Angles are in degrees.

Thermal Specifications

Parameter	Ratio
Operating Case Temperature (T _{OC})	-40 to +85°C
Thermal Power Dissipation (P _D)	W
Junction Temperature (T _{JC})	°C

Notes:
 1. The thermal resistance is referenced from the hottest part of the junction to the ground slug (beneath the device). It corresponds to the typical biasing condition of 800mA at an ambient case temperature. A minimum MTF of 1 million hours is achieved for junction temperature at 247°C. T_{JC} is a function of the package area and 7 and the current applied to pins 6, 7, and 8 can be calculated by:
 $T_{JC} = T_{OC} + R_{th} * V_{cc} * I_{cc}$

MTTF vs. GND Tab Temperature

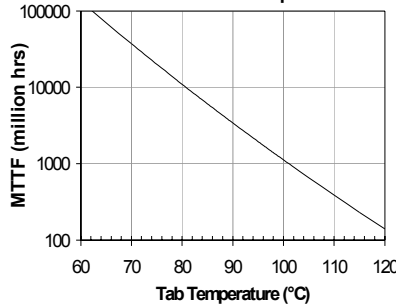

Specifications and information are subject to change without notice.

AH312 / ECP200G

2 Watt, High Linearity InGaP HBT Amplifier

Product Information



AH312-S8G (Lead-Free Package) Mechanical Information

This package is lead-free/green/RoHS-compliant. The plating material on the leads is NiPdAu. It is compatible with both lead-free (maximum 260°C reflow temperature) and lead (maximum 245°C reflow temperature) soldering processes.

Outline Drawing

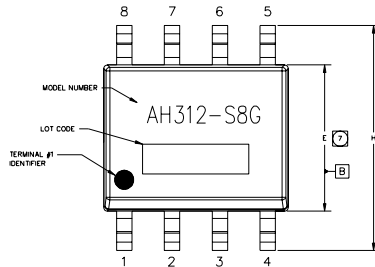

- NOTES:
- EXCEPT WHERE NOTED, THIS PART OUTLINE CONFORMS TO JEDEC STANDARD MS-012, ISSUE C FOR SMALL OUTLINE (SO) PERIPHERAL TERMINALS 3.75mm BODY WIDTH (PLASTIC).
 - DIMENSIONING & TOLERANCING CONFORM TO ANSI Y14.4M-1994.
 - ALL DIMENSIONS ARE IN MILLIMETERS (INCHES). ANGLES ARE IN DEGREES.
 - DOES NOT INCLUDE MOLD FLASH, PROTRUSIONS OR GATE BURRS, WHICH SHALL NOT EXCEED .15mm(.005in) PER SIDE.
 - DEVIATION FROM JEDEC MS-012 STANDARD.
 - LENGTH OF TERMINAL FOR SOLDERING TO A SUBSTRATE.
 - DOES NOT INCLUDE INTER-LEAD FLASH OR PROTRUSIONS, WHICH SHALL NOT EXCEED .25mm(.010in) PER SIDE.

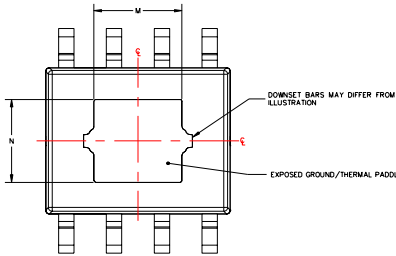
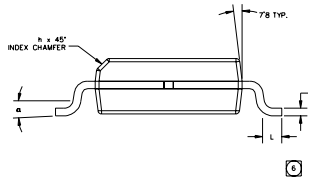
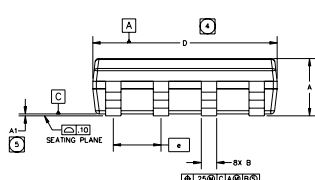

SYMBOL	MILLIMETERS			INCHES		
	MIN	NOM	MAX	MIN	NOM	MAX
A	1.42	1.52	1.62	.056	.060	.064
AT	0	.05	.10	0	.002	.004
B	.38	.41	.43	.015	.016	.017
C	.19	.20	.25	.007	.008	.010
D	4.80	4.90	5.00	.189	.193	.197
E	3.80	3.90	4.00	.150	.154	.157
e	1.27 BSC			.050 BSC		
H	5.80	6.0	6.20	.228	.236	.244
h	.25	.33	.50	.01	.013	.02
L	.40	.84	1.27	.016	.033	.050
M	2.21	2.34	2.47	.087	.092	.097
N	2.08	2.21	2.34	.082	.087	.092
a	0	4.8	8.8	0	4.8	8.8

Product Marking

The component will be marked with an "AH312-S8G" designator with an alphanumeric lot code on the top surface of the package.

Tape and reel specifications for this part are located on the website in the "Application Notes" section.

ESD / MSL Information



Caution! ESD sensitive device.

ESD Rating: Class 1B
 Value: Passes between 500 and 1000V
 Test: Human Body Model (HBM)
 Standard: JEDEC Standard JESD22-A114

MSL Rating: Level 2 at +260° C convection reflow
 Standard: JEDEC Standard J-STD-020

Mounting Config. Notes

- A heatsink underneath the area of the PCB for the mounted device is strictly required for proper thermal operation. Damage to the device can occur without the use of one.
- Ground / thermal vias are critical for the proper performance of this device. Vias should use a .35mm (#80 / .0135") diameter drill and have a final plated thru diameter of .25 mm (.010").
- Add as much copper as possible to inner and outer layers near the part to ensure optimal thermal performance.
- Mounting screws can be added near the part to fasten the board to a heatsink. Ensure that the ground / thermal via region contacts the heatsink.
- Do not put solder mask on the backside of the PC board in the region where the board contacts the heatsink.
- RF trace width depends upon the PC board material and construction.
- Use 1 oz. Copper minimum.
- All dimensions are in millimeters (inches). Angles are in degrees.

Mounting Configuration / Land Pattern

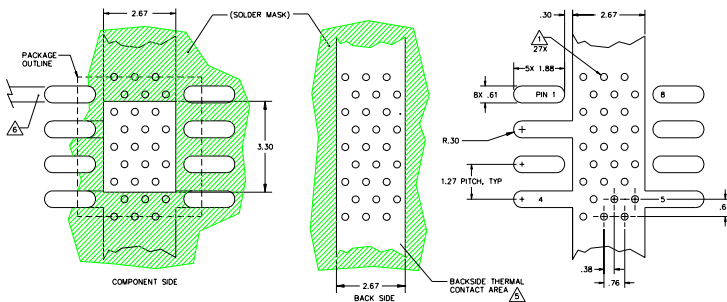

Thermal Specifications

Parameter	Rating
Operating Case Temperature	-40 to +85° C
Thermal Resistance, Rth ⁽¹⁾	17.5° C / W
Junction Temperature, Tjc ⁽²⁾	155° C

Notes:

- The thermal resistance is referenced from the hottest part of the junction to the ground slug underneath the device.
- This corresponds to the typical biasing condition of +5V, 800 mA at an 85° C case temperature. A minimum MTTF of 1 million hours is achieved for junction temperatures below 247° C. Tjc is a function of the voltage at pins 6 and 7 and the current applied to pins 6, 7, and 8 and can be calculated by:

$$T_{jc} = T_{case} + R_{th} * V_{cc} * I_{cc}$$

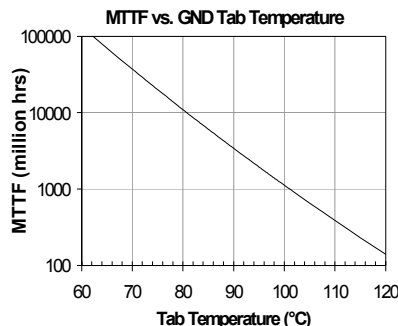

Specifications and information are subject to change without notice.

AH312 / ECP200G

2 Watt, High Linearity InGaP HBT Amplifier

Product Information



ECP200G (SOIC-8 Package) Mechanical Information

This package may contain lead-bearing materials. The plating material on the leads is SnPb.

Outline Drawing

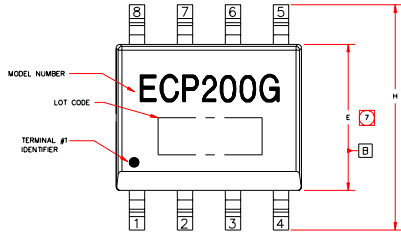

- NOTES:
- EXCEPT WHERE NOTED, THIS PART OUTLINE CONFORMS TO JEDEC STANDARD MS-012, ISSUE C FOR SMALL OUTLINE (SO) PERIPHERAL TERMINALS 3.75mm BODY WIDTH (PLASTIC).
 - DIMENSIONING & TOLERANCING CONFORM TO ASME Y14.4M-1994.
 - ALL DIMENSIONS ARE IN MILLIMETERS. ANGLES ARE IN DEGREES.
 - DOES NOT INCLUDE MOLD FLASH, PROTRUSIONS OR GATE BURRS, WHICH SHALL NOT EXCEED .15mm(.006in) PER SIDE.
 - DEVIATION FROM JEDEC MS-012 STANDARD.
 - LENGTH OF TERMINAL FOR SOLDERING TO A SUBSTRATE.
 - DOES NOT INCLUDE INTER-LEAD FLASH OR PROTRUSIONS, WHICH SHALL NOT EXCEED .25mm(.010in) PER SIDE.

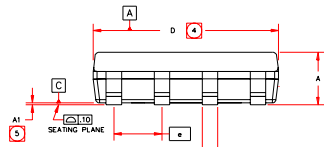

h x 45° INDEX CHAMFER

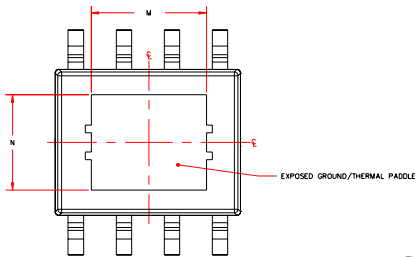

Land Pattern

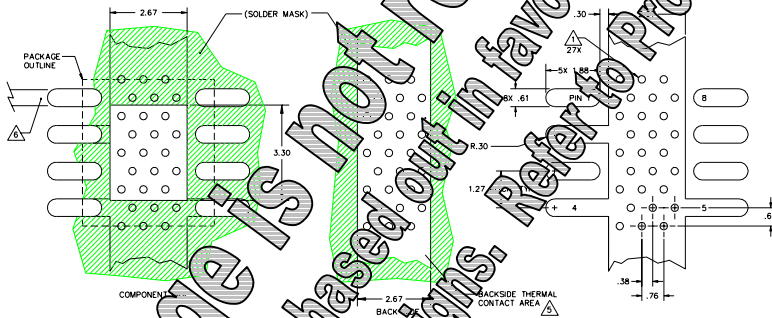

SYMBOL	MILLIMETERS	
	MIN.	MAX.
A	1.30	.059
A1	0	.004
B	.35	.017
C	0	.009
D	1.89	.15
E	1.50	.150
e	0	.050
h	.50	.228
h1	1.27	.016
h2	3.15	.127
h3	2.54	.100
h4	0	.87

Product Marking

The component will be marked with an "ECP200G" identifier with an alphanumeric lot code on the top surface of the package.

Tap reel specifications for this part are located on the website "Application" section.

ESD, MSL Information

- ESD Sensitive Device
- ESD Rating: Class 1B
- Value: Passes between 500 and 1000V
- Test Method: Human Body Model (HBM)
- Standard: JEDEC Standard JESD22-A114
- Thermal Rating: Level 3 at +235° C convection reflow
- Standard: JEDEC Standard J-STD-020

Mounting Config. Notes

- A heatsink underneath the area of the PCB for the mounted device is strictly required for proper thermal operation. Damage to the device can occur without the use of one.
- Ground / thermal vias are critical for the proper performance of this device. Vias should use a .35mm (#80 / .0135") diameter drill and have a final plated thru diameter of .25 mm (.010").
- Add as much copper as possible to inner and outer layers near the part to ensure optimal thermal performance.
- Mounting screws can be added near the part to fasten the board to a heatsink. Ensure that the ground / thermal via region contacts the heatsink.
- Do not put solder mask on the backside of the PC board in the region where the board contacts the heatsink.
- RF trace width depends upon the PC board material and construction.
- Use 1 oz. Copper minimum.
- All dimensions are in millimeters (inches). Angles are in degrees.

Thermal Specifications

Parameter	Rating
Operating Case Temperature	40 to 125° C
Thermal Resistance, Rth(j-c)	1.5 C / W
Junction Temperature (2)	125° C

Notes:

- The thermal resistance is referenced from the junction to case at a temperature of 85° C. Tjc is a function of the voltage across the device and the current applied to pins 6, 7, and 8 and can be calculated by: $T_{jc} = R_{th(j-c)} * I_{cc} * I_{cc}$
- This corresponds to a typical biasing condition of +5V, 80 mA, at 85° C case temperature. A minimum MTTF of 1 million hours is achieved for junction temperatures below 247° C.

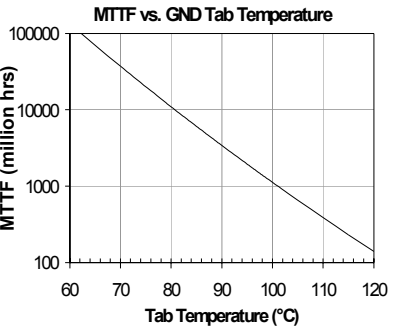

Specifications and information are subject to change without notice.