

FAN4113

1.2V, 36MHz, Low Power Rail-to-Rail Amplifier

Features at +1.2V

- 640 μ A supply current per amplifier
- 36MHz gain bandwidth product
- Output voltage range: 0.06V to 1.10V
- Input voltage range: -0.4V to +0.2V
- 8V/ μ s slew rate
- 12nV/ $\sqrt{\text{Hz}}$ input voltage noise
- Package option (SC70-5)
- Fully specified at +1.2V, +2.7V, and +5V supplies

Applications

- Cellular phones
- Personal data assistants
- A/D buffer
- DSP interface
- Smart card readers
- Portable test instruments
- Single cell NiCd/Ni MH powered systems
- Keyless entry
- Infrared receivers for remote controls
- Telephone systems
- Audio applications

Description

The FAN4113 is a low cost, voltage feedback amplifier that consumes only 640 μ A of supply current. The FAN4113 is designed to operate from +1.2V to 5.5V (± 2.75 V) supplies. The common mode voltage range extends below the negative rail and the output provides rail-to-rail performance.

The FAN4113 is designed on a complementary bipolar process and provides 36MHz of bandwidth and 8V/ μ s of slew rate at a low supply voltage of 1.2V. The combination of low power, rail-to-rail performance, low voltage operation, and tiny package options make the FAN4113 well suited for use in personal electronics equipment such as cellular handsets, pagers, PDAs, and other battery powered applications.

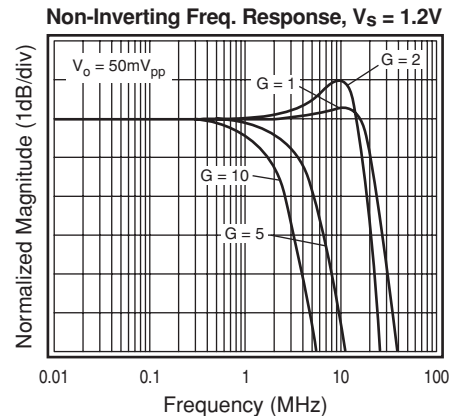

Typical Application

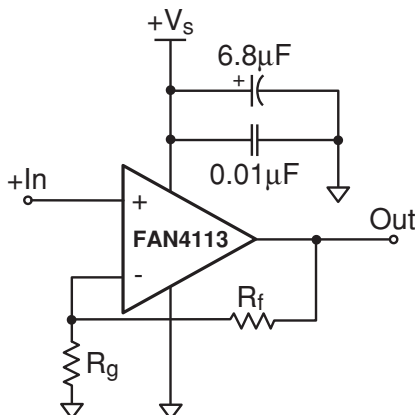

Pin Assignments

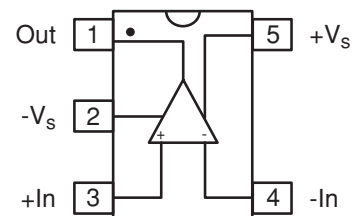

Absolute Maximum Ratings

Parameter	Min.	Max.	Unit
Supply Voltages	0	+6	V
Maximum Junction Temperature	–	+175	°C
Storage Temperature Range	-65	+150	°C
Lead Temperature, 10 seconds	–	+260	°C
Operating Temperature Range, recommended	-40	+85	°C
Input Voltage Range	$-V_S - 0.5$	$+V_S + 0.5$	V
θ_{ja} for 5 load SC70	331.4°C/W		

Electrical Specifications

($T_C = 25^\circ\text{C}$, $V_S = +1.2\text{V}$, $G = 2$, $R_L = 5\text{k}\Omega$ to $V_S/2$, $R_f = 5\text{k}\Omega$, $V_O(\text{DC}) = V_{CC}/2$; unless otherwise noted)

Parameter	Conditions	Min.	Typ.	Max.	Unit
AC Performance					
-3dB Bandwidth ¹	$G = +2$, $V_O = 50\text{mV}_{pp}$		20		MHz
Full Power Bandwidth	$G = +2$, $V_O = 500\text{mV}_{pp}$		9		MHz
Gain Bandwidth Product			36		MHz
Rise and Fall Time	200mV_{pp}		25		ns
Overshoot	200mV_{pp}		6		%
Slew Rate	500mV_{pp}		8		V/ μs
2nd Harmonic Distortion	0.5V_{pp} , 500kHz		75		dBc
3rd Harmonic Distortion	0.5V_{pp} , 500kHz		84		dBc
THD	0.5V_{pp} , 500kHz		0.018		%
Input Voltage Noise	>100kHz		12		nV/ $\sqrt{\text{Hz}}$
DC Performance					
Input Offset Voltage			0.5		mV
Average Drift			2		$\mu\text{V}/^\circ\text{C}$
Input Bias Current			400		nA
Average Drift			2		nA/ $^\circ\text{C}$
Input Offset Current			30		nA
Power Supply Rejection Ratio	DC		80		dB
Open Loop Gain			65		dB
Supply Current			640		μA
Input Characteristics					
Input Resistance			25		M Ω
Input Capacitance			1.8		pF
Input Common Mode Voltage Range			-0.4 to 0.2		V
Common Mode Rejection Ratio			72		dB
Output Characteristics					
Output Voltage Swing	$R_L = 5\text{k}\Omega$ to $V_S/2$		0.05 to 1.11		V
	$R_L = 1\text{k}\Omega$ to $V_S/2$		0.07 to 1.03		V
Output Current			± 1.2		mA
Short Circuit Output Current			± 1.8		mA
Power Supply Operating Range		1.2	1.2	5.5	V

Min/max ratings are based on product characterization and simulation. Individual parameters are tested as noted. Outgoing quality levels are determined from tested parameters.

Notes:

1. For $G = +1$, $R_f = 0$.

Electrical Specifications

($T_C = 25^\circ\text{C}$, $V_S = +2.7\text{V}$, $G = 2$, $R_L = 5\text{k}\Omega$ to $V_S/2$, $R_f = 5\text{k}\Omega$, $V_O(\text{DC}) = V_{CC}/2$; unless otherwise noted)

Parameter	Conditions	Min.	Typ.	Max.	Unit
AC Performance					
-3dB Bandwidth ¹	$G = +1$, $V_O = 50\text{mV}_{pp}$		42		MHz
	$G = +2$, $V_O = 50\text{mV}_{pp}$		20		MHz
Full Power Bandwidth	$G = +2$, $V_O = 500\text{mV}_{pp}$		9		MHz
Gain Bandwidth Product			35		MHz
Rise and Fall Time	200mV_{pp}		25		ns
Settling Time to 1%	1V_{pp}		200		ns
Overshoot	200mV_{pp}		4		%
Slew Rate	1V_{pp}		8		V/ μs
2nd Harmonic Distortion	0.5V_{pp} , 500kHz		75		dBc
3rd Harmonic Distortion	0.5V_{pp} , 500kHz		84		dBc
THD	0.5V_{pp} , 500kHz		0.018		%
Input Voltage Noise	>100kHz		12		nV/ $\sqrt{\text{Hz}}$
DC Performance					
Input Offset Voltage ²		-2.5	0.5	+2.5	mV
Average Drift			2		$\mu\text{V}/^\circ\text{C}$
Input Bias Current ²			400	800	nA
Average Drift			2		nA/ $^\circ\text{C}$
Input Offset Current			30		nA
Power Supply Rejection Ratio ²	DC	66	80		dB
Open Loop Gain			70		dB
Supply Current ²			750	900	μA
Input Characteristics					
Input Resistance			25		M Ω
Input Capacitance			1.4		pF
Input Common Mode Voltage Range			-0.4 to 1.7		V
Common Mode Rejection Ratio ²		66	75		dB
Output Characteristics					
Output Voltage Swing	$R_L = 5\text{k}\Omega$ to $V_S/2^2$	0.085 to 2.55	0.04 to 2.64		V
	$R_L = 1\text{k}\Omega$ to $V_S/2$		0.07 to 2.56		V
Output Current			± 9		mA
Short Circuit Output Current			± 11		mA
Power Supply Operating Range		1.2	2.7	5.5	V

Min/max ratings are based on product characterization and simulation. Individual parameters are tested as noted. Outgoing quality levels are determined from tested parameters.

Notes:

- For $G = +1$, $R_f = 0$.
- 100% tested at $+25^\circ\text{C}$.

Electrical Specifications

($T_C = 25^\circ\text{C}$, $V_S = +5\text{V}$, $G = 2$, $R_L = 5\text{k}\Omega$ to $V_S/2$, $R_f = 5\text{k}\Omega$, $V_O(\text{DC}) = V_{CC}/2$; unless otherwise noted)

Parameter	Conditions	Min.	Typ.	Max.	Unit
AC Performance					
-3dB Bandwidth ¹	$G = +1$, $V_O = 50\text{mV}_{pp}$		36		MHz
	$G = +2$, $V_O = 50\text{mV}_{pp}$		20		MHz
Full Power Bandwidth	$G = +2$, $V_O = 500\text{mV}_{pp}$		9		MHz
Gain Bandwidth Product			31		MHz
Rise and Fall Time	200mV_{pp}		25		ns
Settling Time to 1%	$2V_{pp}$		250		ns
Overshoot	200mV_{pp}		2		%
Slew Rate	$2V_{pp}$		8		V/ μs
2nd Harmonic Distortion	$0.5V_{pp}$, 500kHz		75		dBc
3rd Harmonic Distortion	$0.5V_{pp}$, 500kHz		84		dBc
THD	$0.5V_{pp}$, 500kHz		0.018		%
Input Voltage Noise	>100kHz		12		nV/ $\sqrt{\text{Hz}}$
DC Performance					
Input Offset Voltage			0.5		mV
Average Drift			2		$\mu\text{V}/^\circ\text{C}$
Input Bias Current			400		nA
Average Drift			2		nA/ $^\circ\text{C}$
Input Offset Current			30		nA
Power Supply Rejection Ratio	DC		80		dB
Open Loop Gain			70		dB
Supply Current			750		μA
Input Characteristics					
Input Resistance			25		M Ω
Input Capacitance			1.25		pF
Input Common Mode Voltage Range			-0.4 to 4.0		V
Common Mode Rejection Ratio			76		dB
Output Characteristics					
Output Voltage Swing	$R_L = 5\text{k}\Omega$ to $V_S/2$		0.03 to 4.92		V
	$R_L = 1\text{k}\Omega$ to $V_S/2$		0.07 to 4.79		V
Output Current			± 9		mA
Short Circuit Output Current			± 13		mA
Power Supply Operating Range		1.2	5	5.5	V

Min/max ratings are based on product characterization and simulation. Individual parameters are tested as noted. Outgoing quality levels are determined from tested parameters.

Notes:

- For $G = +1$, $R_f = 0$.

Typical Operating Characteristics

($T_C = 25^\circ\text{C}$, $V_S = +2.7\text{V}$, $G = 2$, $R_L = 5\text{k}\Omega$ to $V_S/2$, $R_f = 5\text{k}\Omega$, $V_O(\text{DC}) = V_{CC}/2$; unless otherwise noted)

Non-Inverting Frequency Response

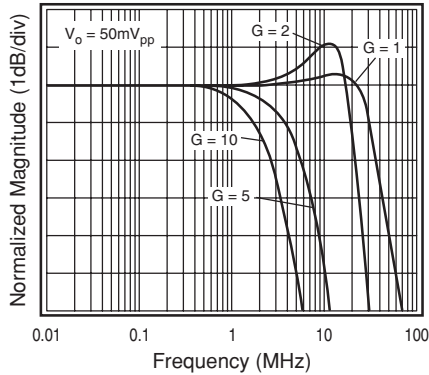

Inverting Frequency Response

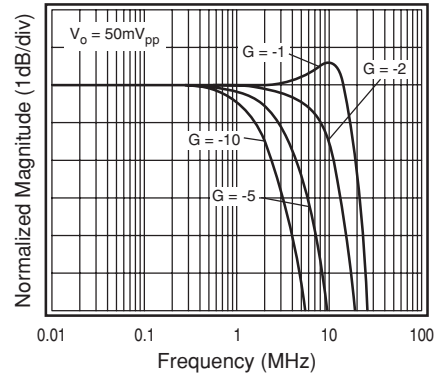

Non-Inverting Freq. Response, $V_S = 1.2\text{V}$

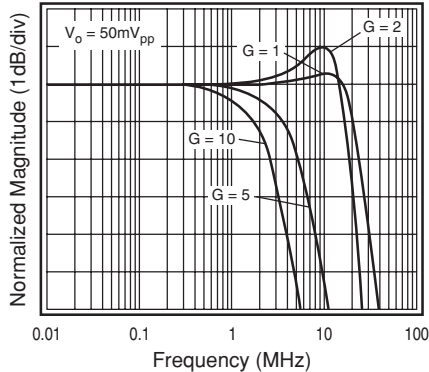

Inverting Freq. Response, $V_S = 1.2\text{V}$

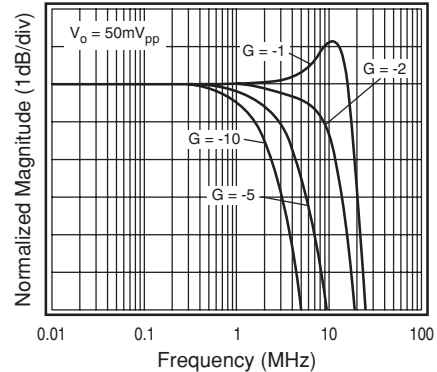

Large Signal Frequency Response

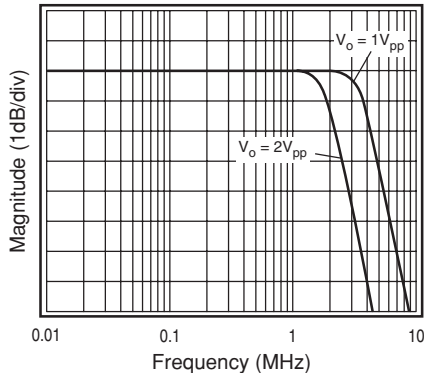

Open Loop Gain & Phase vs. Frequency

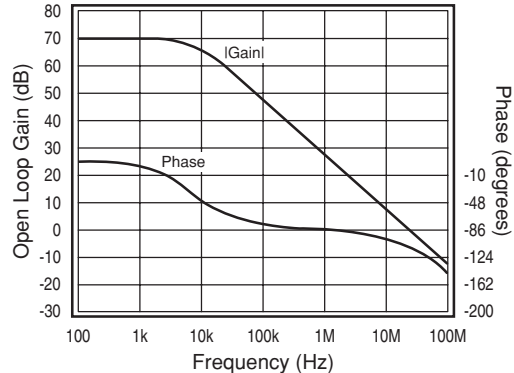

Input Voltage Noise

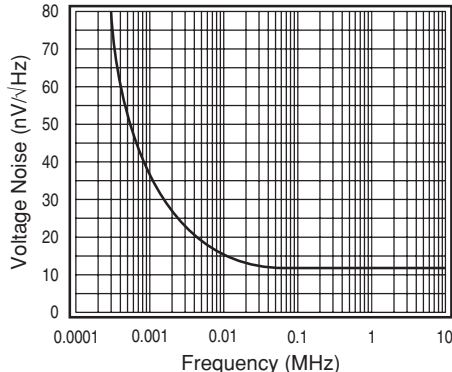

Harmonic Distortion vs. Frequency

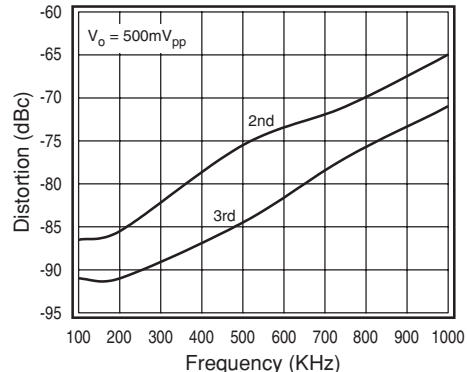

Typical Operating Characteristics

($T_C = 25^\circ\text{C}$, $V_S = +2.7\text{V}$, $G = 2$, $R_L = 5\text{k}\Omega$ to $V_S/2$, $R_f = 5\text{k}\Omega$, $V_O(\text{DC}) = V_{CC}/2$; unless otherwise noted)

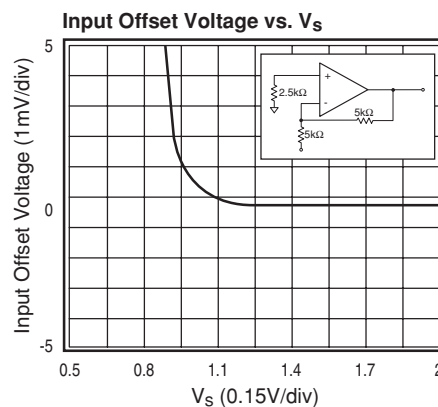
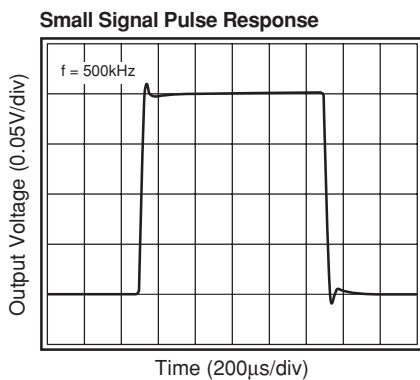
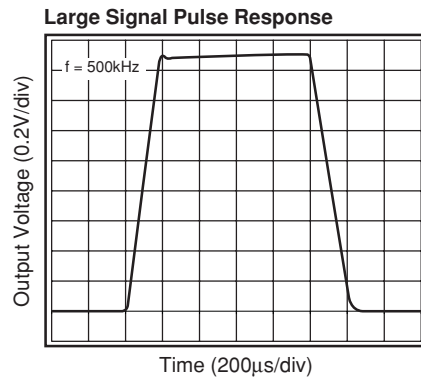
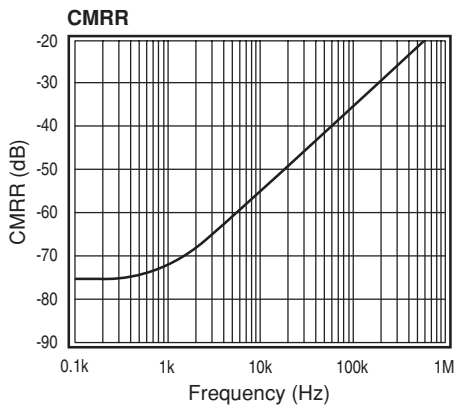
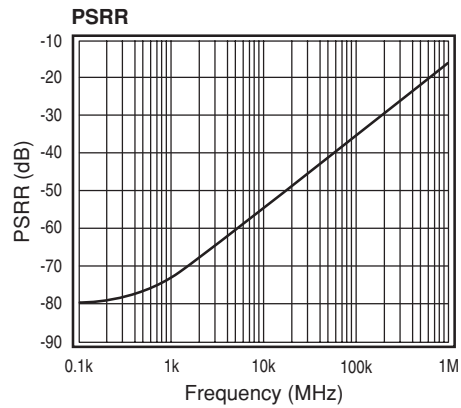
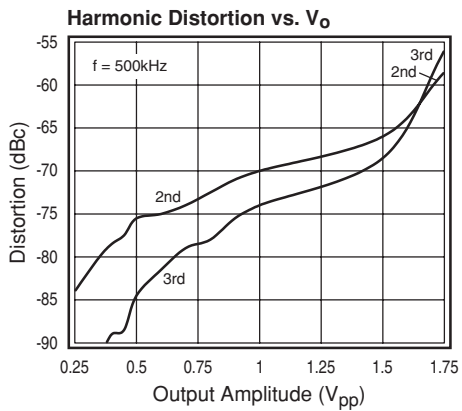
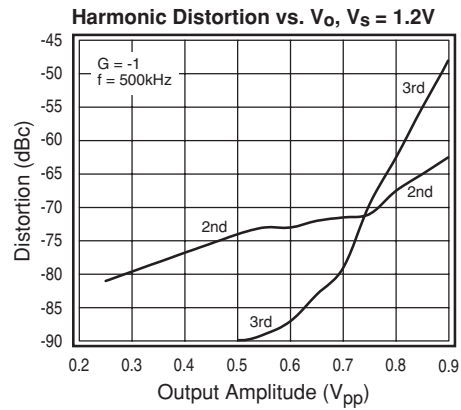
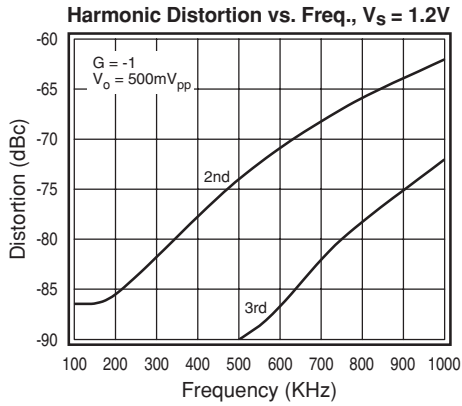

Application Information

General Description

The FAN4113 is single supply, general purpose, voltage-feedback amplifier. The FAN4113 is fabricated on a complimentary bipolar process, features a rail-to-rail output, and its unity gain stable.

The typical non-inverting circuit schematic is shown in Figure 1.

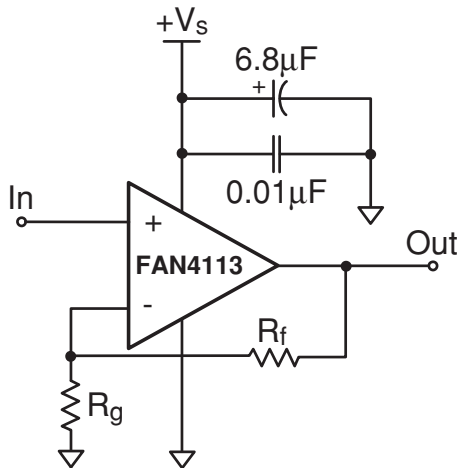

Figure 1: Typical Non-inverting Configuration

RR Applications and Beyond

The FAN4113 can be used with input signals that exceed its common mode input voltage range. Simply attenuate the input signal and increase the gain of the FAN4113, see Figure 2. First, select A_1 so the FAN4113 common voltage range is not exceeded. Second, select R_f and R_g to get the desired overall gain for signal V_{in} . Finally, pick V_{DC} for the desired output offset.

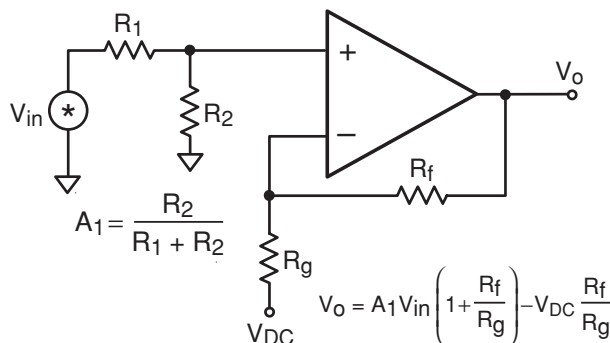

Figure 2: RR Applications and Beyond

Power Dissipation

The maximum internal power dissipation allowed is directly related to the maximum junction temperature. If the maximum junction temperature exceeds 150°C, some performance degradation will occur. If the maximum junction temperature exceeds 175°C for an extended time, device failure may occur.

Overdrive Recovery

Overdrive of an amplifier occurs when the output and/or input ranges are exceeded. The recovery time varies based on whether the input or output is overdriven and by how much the ranges are exceeded. The FAN4113 will typically recover in less than 50ns from an overdrive condition. Figure 3 shows the FAN4113 in an overdriven condition.

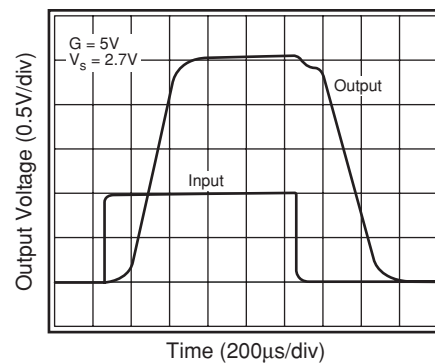

Figure 3: Overdrive Recovery

Driving Capacitive Loads

The Frequency Response vs. C_L plot, illustrates the response of the FAN4113. A small series resistance (R_s) at the output of the amplifier, illustrated in Figure 4, will improve stability and settling performance.

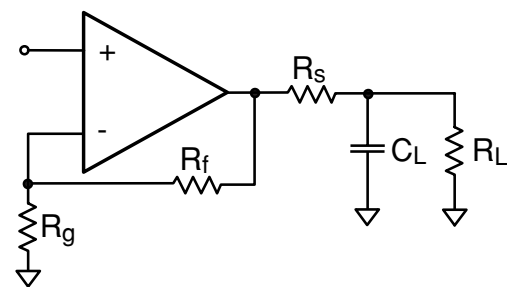

Figure 4: Typical Topology for driving a capacitive load

Layout Considerations

General layout and supply bypassing play major roles in high frequency performance. Fairchild has evaluation boards to use as a guide for high frequency layout and as aid in device testing and characterization. Follow the steps below as a basis for high frequency layout:

- Include 6.8 μ F and 0.01 μ F ceramic capacitors
- Place the 6.8 μ F capacitor within 0.75 inches of the power pin
- Place the 0.01 μ F capacitor within 0.1 inches of the power pin
- Remove the ground plane under and around the part, especially near the input and output pins to reduce parasitic capacitance
- Minimize all trace lengths to reduce series inductances

Refer to the evaluation board layouts shown in Figure 6 for more information.

Evaluation Board Information

The following evaluation boards are available to aid in the testing and layout of this device:

Eval Bd	Description	Products
KEB011	Single Channel, Dual Supply, 5 and 6 lead SC70	FAN4113IP5

Evaluation board schematics and layouts are shown in Figure 5 and Figure 6.

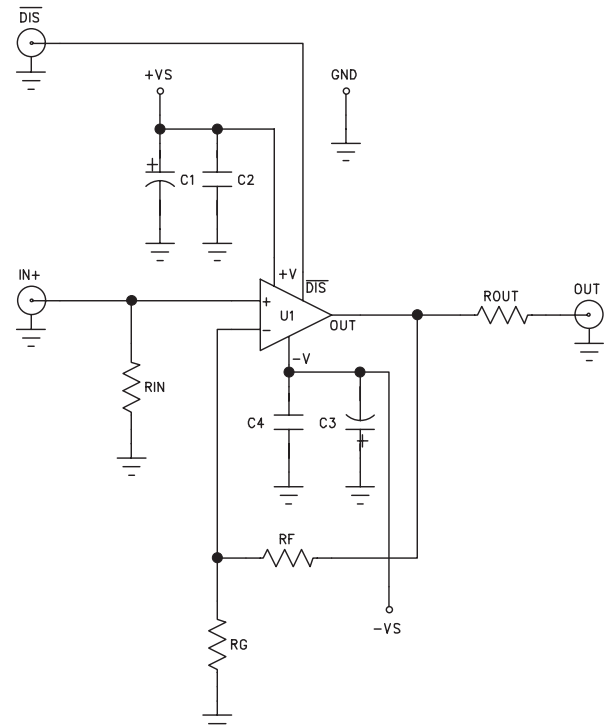

Figure 5: Evaluation Board Schematic

FAN4113 Evaluation Board Layout

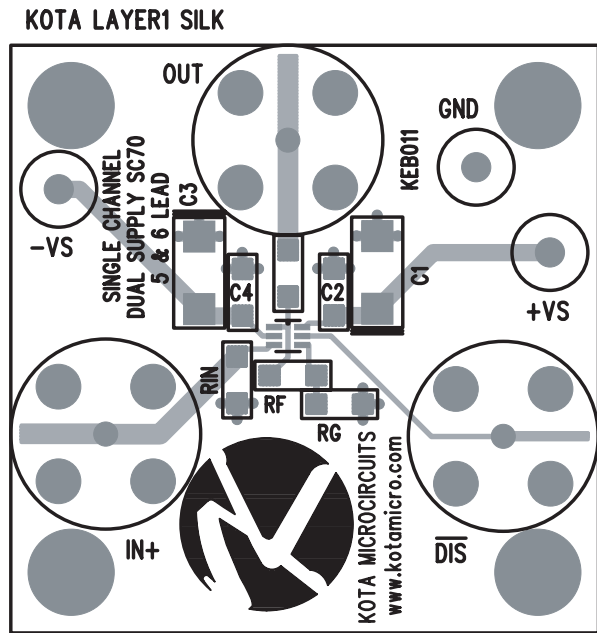

Figure 6a: KEB011 (top side)

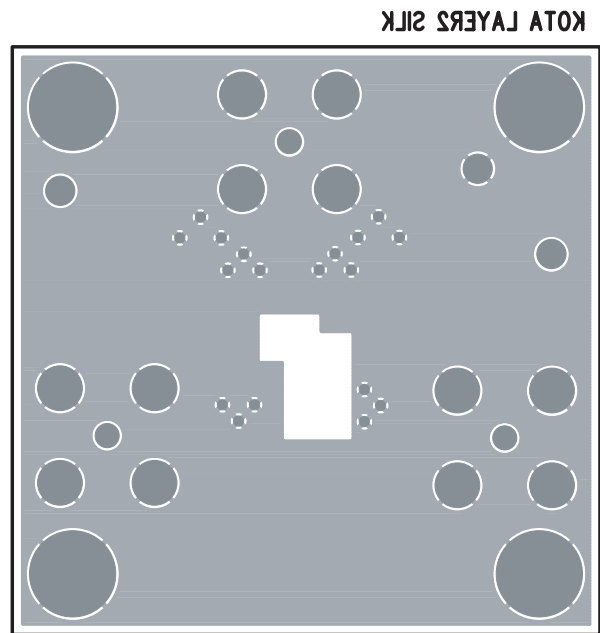
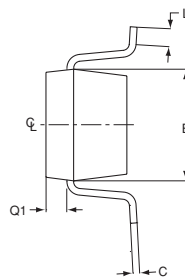
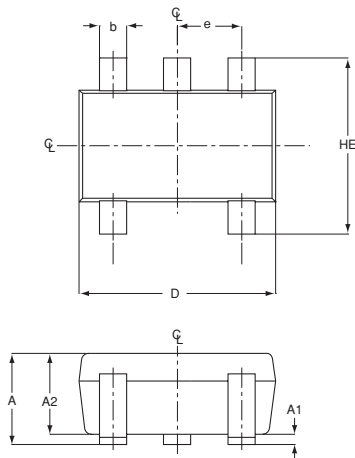

Figure 6b: KEB011 (bottom side)

FAN4113 Package Dimensions

SC70-5



SYMBOL	MIN	MAX
e	0.65 BSC	
D	1.80	2.20
b	0.15	0.30
E	1.15	1.35
HE	1.80	2.40
Q1	0.10	0.40
A2	0.80	1.00
A1	0.00	0.10
A	0.80	1.10
c	0.10	0.18
L	1.10	0.30

NOTE:

1. All dimensions are in millimeters.
2. Dimensions are inclusive of plating.
3. Dimensions are exclusive of mold flashing and metal burr.
4. All specifications comply to EIAJ SC70.

Ordering Information

Model	Part Number	Package	Container	Pack Qty
FAN4113	FAN4113IP5	SC70-5	Partial Reel	<3000
FAN4113	FAN4113IP5X	SC70-5	Reel	3000

Temperature range for all parts: -40°C to +85°C.

DISCLAIMER

FAIRCHILD SEMICONDUCTOR RESERVES THE RIGHT TO MAKE CHANGES WITHOUT FURTHER NOTICES TO ANY PRODUCTS HEREIN TO IMPROVE RELIABILITY, FUNCTION OR DESIGN. FAIRCHILD DOES NOT ASSUME ANY LIABILITY ARISING OUT OF THE APPLICATION OR USE OF ANY PRODUCT OR CIRCUIT DESCRIBED HEREIN; NEITHER DOES IT CONVEY ANY LICENSE UNDER ITS PATENT RIGHTS, NOR THE RIGHTS OF OTHERS.

LIFE SUPPORT POLICY

FAIRCHILD'S PRODUCTS ARE NOT AUTHORIZED FOR USE AS CRITICAL COMPONENTS IN LIFE SUPPORT DEVICES OR SYSTEMS WITHOUT THE EXPRESS WRITTEN APPROVAL OF THE PRESIDENT OF FAIRCHILD SEMICONDUCTOR CORPORATION. As used herein:

1. Life support devices or systems are devices or systems which, (a) are intended for surgical implant into the body, or (b) support or sustain life, and (c) whose failure to perform when properly used in accordance with instructions for use provided in the labeling, can be reasonably expected to result in a significant injury of the user.
2. A critical component in any component of a life support device or system whose failure to perform can be reasonably expected to cause the failure of the life support device or system, or to affect its safety or effectiveness.