

63A, 1200V, NPT Series N-Channel IGBT with Anti-Parallel Hyperfast Diode

The HGTG20N120CND is a **Non-Punch Through (NPT)** IGBT design. This is a new member of the MOS gated high voltage switching IGBT family. IGBTs combine the best features of MOSFETs and bipolar transistors. This device has the high input impedance of a MOSFET and the low on-state conduction loss of a bipolar transistor.

The IGBT is ideal for many high voltage switching applications operating at moderate frequencies where low conduction losses are essential, such as: AC and DC motor controls, power supplies and drivers for solenoids, relays and contactors.

Formerly Developmental Type TA49305.

Ordering Information

PART NUMBER	PACKAGE	BRAND
HGTG20N120CND	TO-247	20N120CND

NOTE: When ordering, use the entire part number.

Features

- 63A, 1200V, $T_C = 25^\circ\text{C}$
- 1200V Switching SOA Capability
- Typical Fall Time 340ns at $T_J = 150^\circ\text{C}$
- Short Circuit Rating
- Low Conduction Loss

Packaging

JEDEC STYLE TO-247

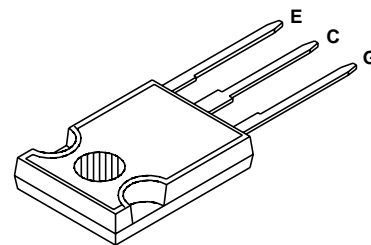

Symbol

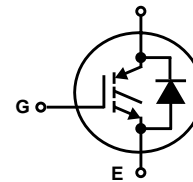

INTERSIL CORPORATION IGBT PRODUCT IS COVERED BY ONE OR MORE OF THE FOLLOWING U.S. PATENTS

4,364,073	4,417,385	4,430,792	4,443,931	4,466,176	4,516,143	4,532,534	4,587,713
4,598,461	4,605,948	4,620,211	4,631,564	4,639,754	4,639,762	4,641,162	4,644,637
4,682,195	4,684,413	4,694,313	4,717,679	4,743,952	4,783,690	4,794,432	4,801,986
4,803,533	4,809,045	4,809,047	4,810,665	4,823,176	4,837,606	4,860,080	4,883,767
4,888,627	4,890,143	4,901,127	4,904,609	4,933,740	4,963,951	4,969,027	

HGTG20N120CND

Absolute Maximum Ratings $T_C = 25^\circ\text{C}$, Unless Otherwise Specified

	HGTG20N120CND	UNITS
Collector to Emitter Voltage	1200	V
Collector Current Continuous		
At $T_C = 25^\circ\text{C}$	63	A
At $T_C = 110^\circ\text{C}$	30	A
Collector Current Pulsed (Note 1)	160	A
Gate to Emitter Voltage Continuous	± 20	V
Gate to Emitter Voltage Pulsed	± 30	V
Switching Safe Operating Area at $T_J = 150^\circ\text{C}$ (Figure 2)	100A at 1200V	
Power Dissipation Total at $T_C = 25^\circ\text{C}$	390	W
Power Dissipation Derating $T_C > 25^\circ\text{C}$	3.12	W/ $^\circ\text{C}$
Operating and Storage Junction Temperature Range	-55 to 150	$^\circ\text{C}$
Maximum Lead Temperature for Soldering	260	$^\circ\text{C}$
Short Circuit Withstand Time (Note 2) at $V_{GE} = 15\text{V}$	8	μs
Short Circuit Withstand Time (Note 2) at $V_{GE} = 12\text{V}$	15	μs

CAUTION: Stresses above those listed in "Absolute Maximum Ratings" may cause permanent damage to the device. This is a stress only rating and operation of the device at these or any other conditions above those indicated in the operational sections of this specification is not implied.

NOTES:

- Pulse width limited by maximum junction temperature.
- $V_{CE(PK)} = 960\text{V}$, $T_J = 125^\circ\text{C}$, $R_G = 3\Omega$.

Electrical Specifications $T_C = 25^\circ\text{C}$, Unless Otherwise Specified

PARAMETER	SYMBOL	TEST CONDITIONS	MIN	TYP	MAX	UNITS	
Collector to Emitter Breakdown Voltage	BV_{CES}	$I_C = 250\mu\text{A}$, $V_{GE} = 0\text{V}$	1200	-	-	V	
Emitter to Collector Breakdown Voltage	BV_{ECS}	$I_C = 10\text{mA}$, $V_{GE} = 0\text{V}$	15	-	-	V	
Collector to Emitter Leakage Current	I_{CES}	$V_{CE} = BV_{CES}$	$T_C = 25^\circ\text{C}$	-	-	250	μA
			$T_C = 125^\circ\text{C}$	-	450	-	μA
			$T_C = 150^\circ\text{C}$	-	-	6	mA
Collector to Emitter Saturation Voltage	$V_{CE(SAT)}$	$I_C = 20\text{A}$, $V_{GE} = 15\text{V}$	$T_C = 25^\circ\text{C}$	-	2.1	2.4	V
			$T_C = 150^\circ\text{C}$	-	2.9	3.5	V
Gate to Emitter Threshold Voltage	$V_{GE(TH)}$	$I_C = 150\mu\text{A}$, $V_{CE} = V_{GE}$	6.0	6.9	-	V	
Gate to Emitter Leakage Current	I_{GES}	$V_{GE} = \pm 20\text{V}$	-	-	± 250	nA	
Switching SOA	SSOA	$T_J = 150^\circ\text{C}$, $R_G = 3\Omega$, $V_{GE} = 15\text{V}$, $L = 200\mu\text{H}$, $V_{CE(PK)} = 1200\text{V}$	100	-	-	A	
Gate to Emitter Plateau Voltage	V_{GEP}	$I_C = 20\text{A}$, $V_{CE} = 0.5 BV_{CES}$	-	10.2	-	V	
On-State Gate Charge	$Q_{G(ON)}$	$I_C = 20\text{A}$, $V_{CE} = 0.5 BV_{CES}$	$V_{GE} = 15\text{V}$	-	155	200	nC
			$V_{GE} = 20\text{V}$	-	200	250	nC
Current Turn-On Delay Time	$t_{d(ON)I}$	IGBT and Diode at $T_J = 25^\circ\text{C}$ $I_{CE} = 20\text{A}$ $V_{CE} = 0.8 BV_{CES}$ $V_{GE} = 15\text{V}$ $R_G = 3\Omega$ $L = 1\text{mH}$ Test Circuit (Figure 20)	-	23	28	ns	
Current Rise Time	t_{rI}		-	17	22	ns	
Current Turn-Off Delay Time	$t_{d(OFF)I}$		-	200	240	ns	
Current Fall Time	t_{fI}		-	220	270	ns	
Turn-On Energy	E_{ON}		-	2.0	2.5	mJ	
Turn-Off Energy (Note 3)	E_{OFF}	-	2.8	3.3	mJ		

HGTG20N120CND

Electrical Specifications $T_C = 25^\circ\text{C}$, Unless Otherwise Specified (Continued)

PARAMETER	SYMBOL	TEST CONDITIONS	MIN	TYP	MAX	UNITS
Current Turn-On Delay Time	$t_{d(ON)I}$	IGBT and Diode at $T_J = 150^\circ\text{C}$ $I_{CE} = 20\text{A}$ $V_{CE} = 0.8 V_{CES}$ $V_{GE} = 15\text{V}$ $R_G = 3\Omega$ $L = 1\text{mH}$ Test Circuit (Figure 20)	-	21	26	ns
Current Rise Time	t_{rI}		-	17	22	ns
Current Turn-Off Delay Time	$t_{d(OFF)I}$		-	225	270	ns
Current Fall Time	t_{fI}		-	340	400	ns
Turn-On Energy	E_{ON}		-	3.8	5.0	mJ
Turn-Off Energy (Note 3)	E_{OFF}		-	4.6	5.3	mJ
Diode Forward Voltage	V_{EC}		$I_{EC} = 20\text{A}$	-	2.6	3.2
Diode Reverse Recovery Time	t_{rr}	$I_{EC} = 20\text{A}, dI_{EC}/dt = 200\text{A}/\mu\text{s}$	-	62	75	ns
		$I_{EC} = 2\text{A}, dI_{EC}/dt = 200\text{A}/\mu\text{s}$	-	44	55	ns
Thermal Resistance Junction To Case	$R_{\theta JC}$	IGBT	-	-	0.32	$^\circ\text{C}/\text{W}$
		Diode	-	-	0.75	$^\circ\text{C}/\text{W}$

NOTE:

- Turn-Off Energy Loss (E_{OFF}) is defined as the integral of the instantaneous power loss starting at the trailing edge of the input pulse and ending at the point where the collector current equals zero ($I_{CE} = 0\text{A}$). All devices were tested per JEDEC Standard No. 24-1 Method for Measurement of Power Device Turn-Off Switching Loss. This test method produces the true total Turn-Off Energy Loss.

Typical Performance Curves Unless Otherwise Specified

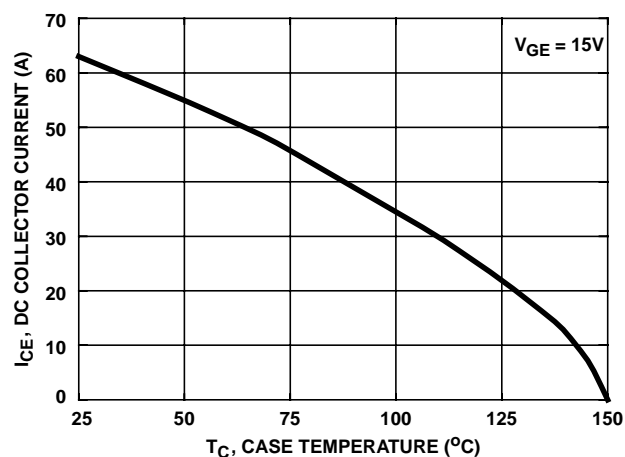

FIGURE 1. DC COLLECTOR CURRENT vs CASE TEMPERATURE

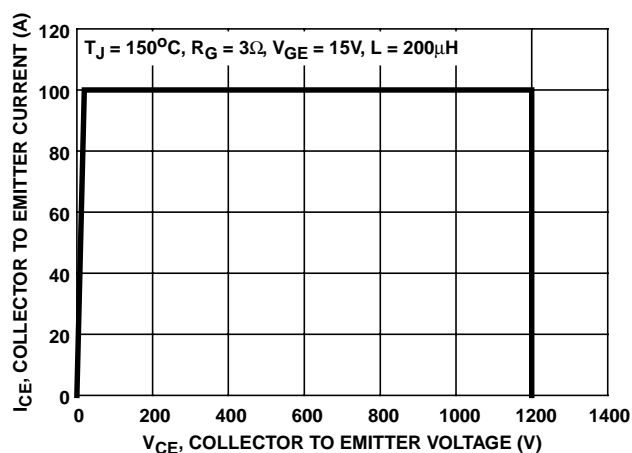

FIGURE 2. MINIMUM SWITCHING SAFE OPERATING AREA

Typical Performance Curves Unless Otherwise Specified (Continued)

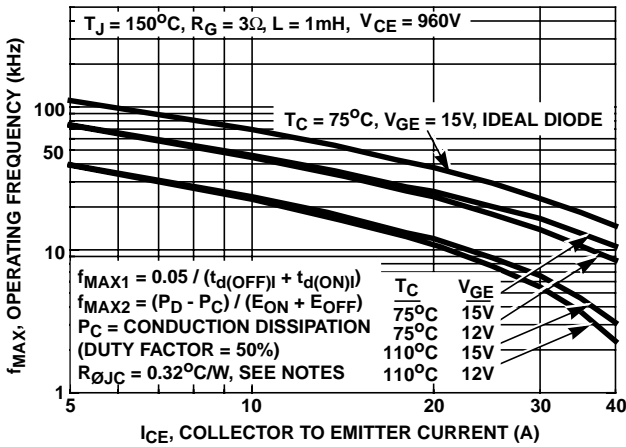

FIGURE 3. OPERATING FREQUENCY vs COLLECTOR TO EMITTER CURRENT

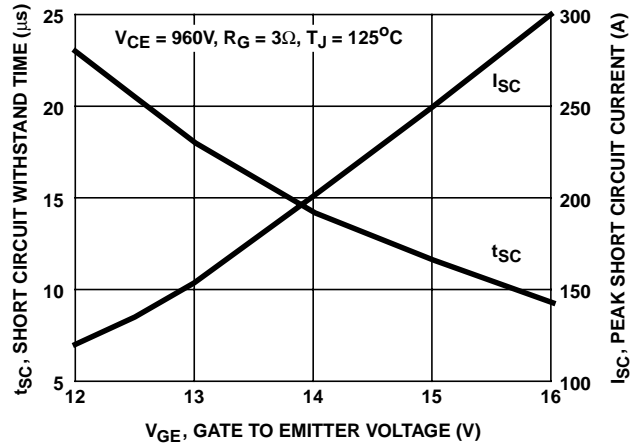

FIGURE 4. SHORT CIRCUIT WITHSTAND TIME

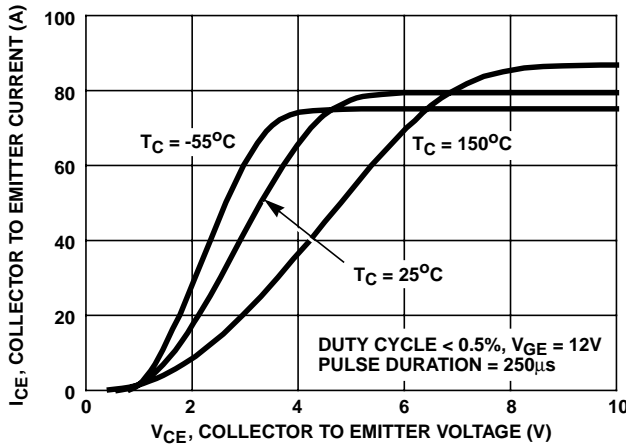

FIGURE 5. COLLECTOR TO EMITTER ON-STATE VOLTAGE

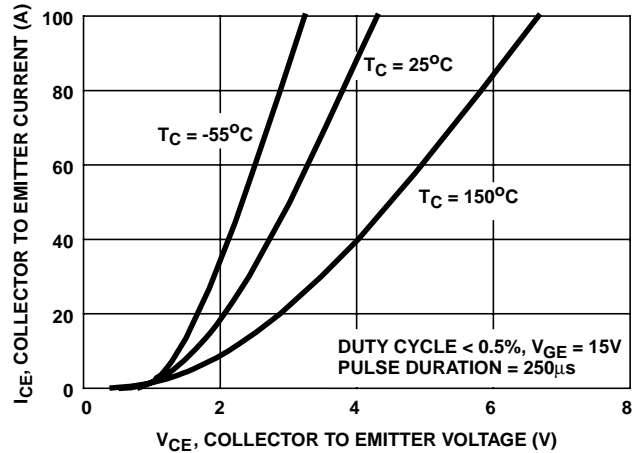

FIGURE 6. COLLECTOR TO EMITTER ON-STATE VOLTAGE

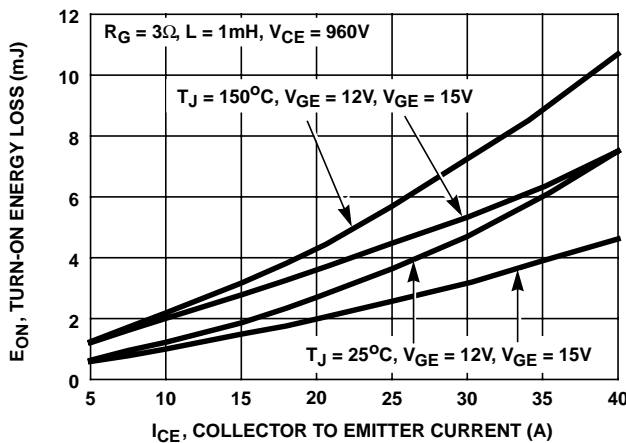

FIGURE 7. TURN-ON ENERGY LOSS vs COLLECTOR TO EMITTER CURRENT

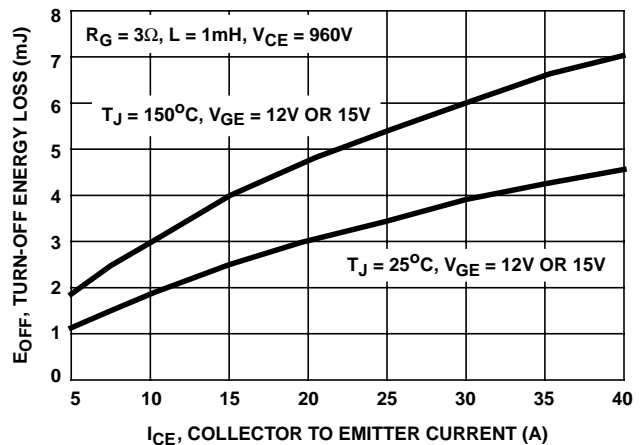

FIGURE 8. TURN-OFF ENERGY LOSS vs COLLECTOR TO EMITTER CURRENT

Typical Performance Curves Unless Otherwise Specified (Continued)

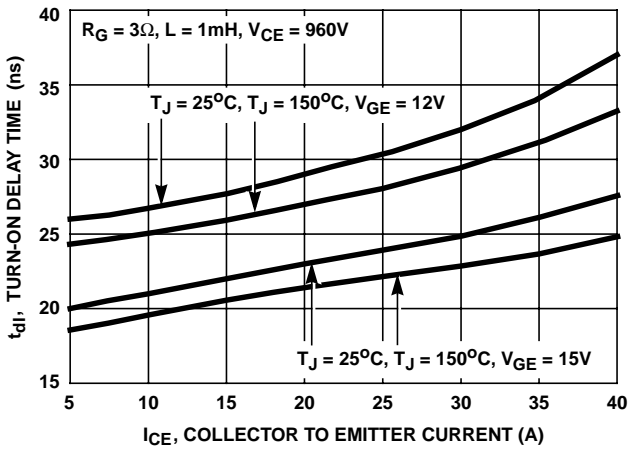

FIGURE 9. TURN-ON DELAY TIME vs COLLECTOR TO EMITTER CURRENT

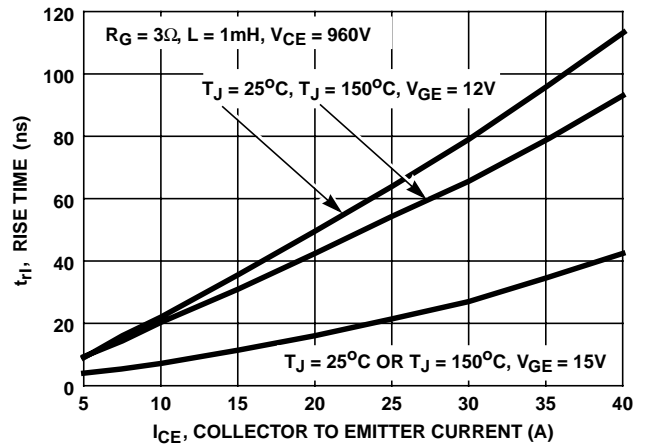

FIGURE 10. TURN-ON RISE TIME vs COLLECTOR TO EMITTER CURRENT

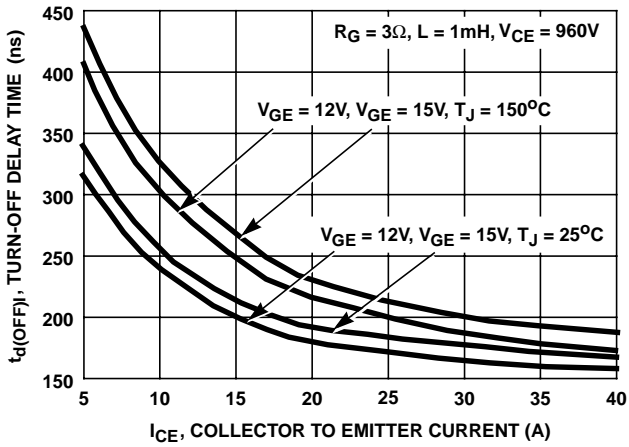

FIGURE 11. TURN-OFF DELAY TIME vs COLLECTOR TO EMITTER CURRENT

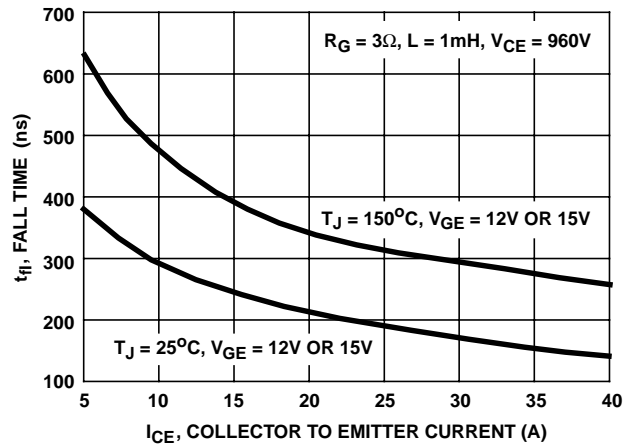

FIGURE 12. FALL TIME vs COLLECTOR TO EMITTER CURRENT

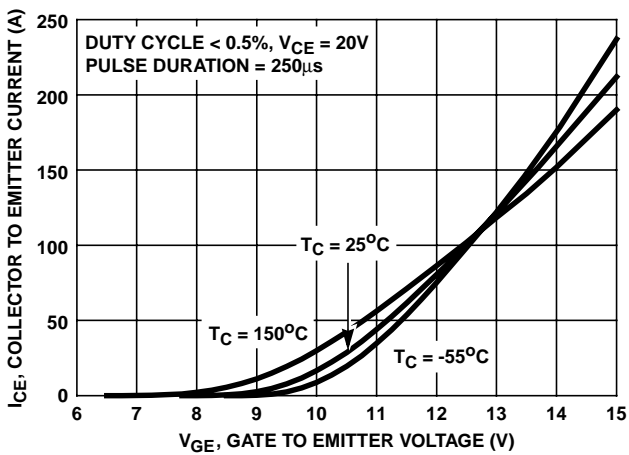

FIGURE 13. TRANSFER CHARACTERISTIC

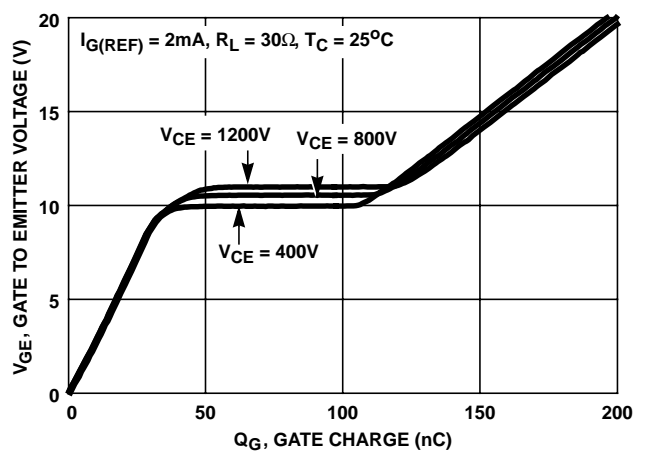

FIGURE 14. GATE CHARGE WAVEFORMS

Typical Performance Curves Unless Otherwise Specified (Continued)

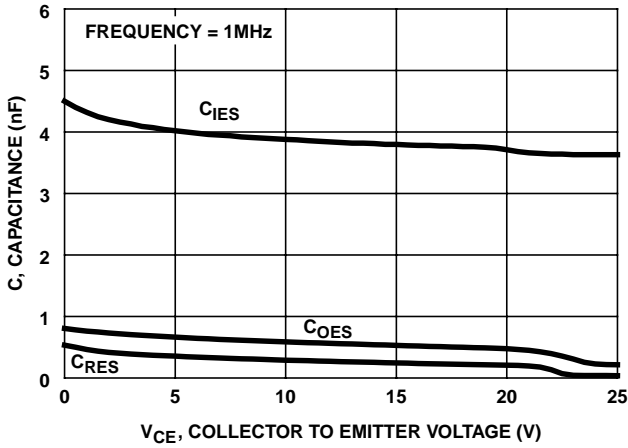

FIGURE 15. CAPACITANCE vs COLLECTOR TO EMITTER VOLTAGE

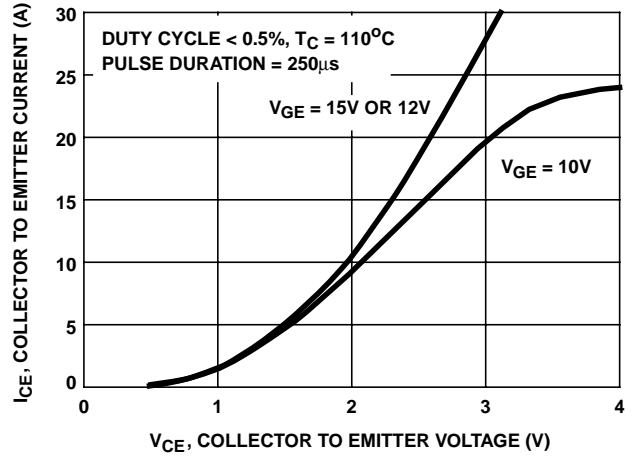

FIGURE 16. COLLECTOR TO EMITTER ON-STATE VOLTAGE

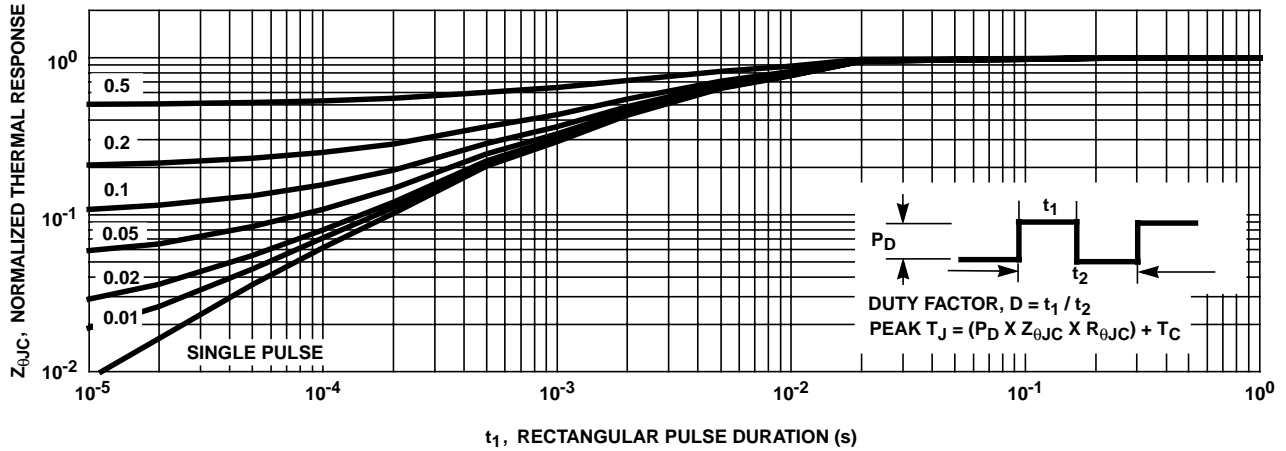

FIGURE 17. NORMALIZED TRANSIENT THERMAL RESPONSE, JUNCTION TO CASE

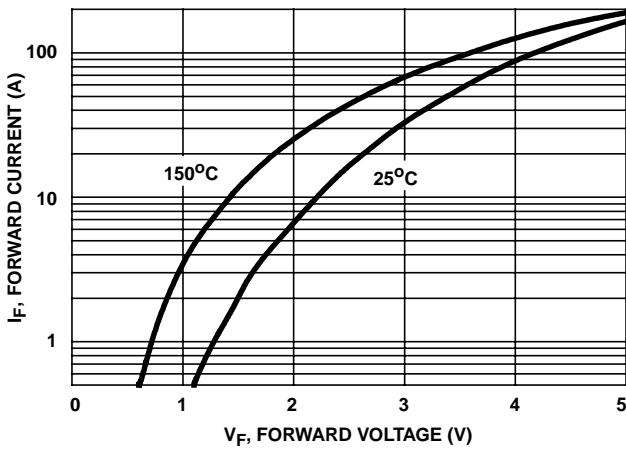

FIGURE 18. DIODE FORWARD CURRENT vs FORWARD VOLTAGE DROP

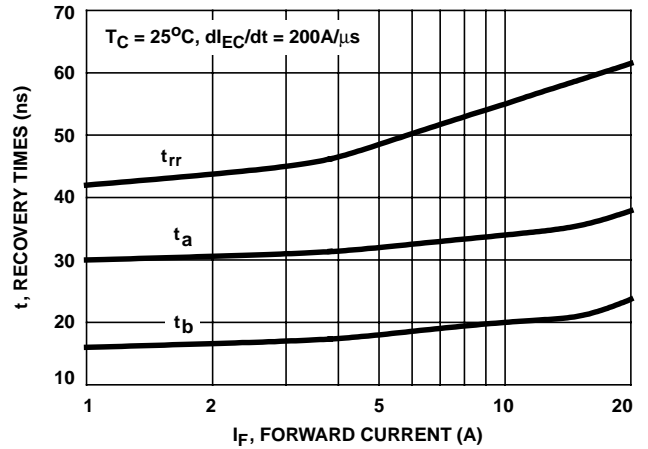

FIGURE 19. RECOVERY TIMES vs FORWARD CURRENT

Test Circuit and Waveforms

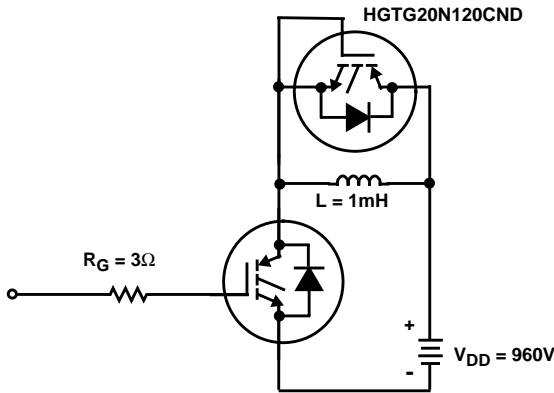

FIGURE 20. INDUCTIVE SWITCHING TEST CIRCUIT

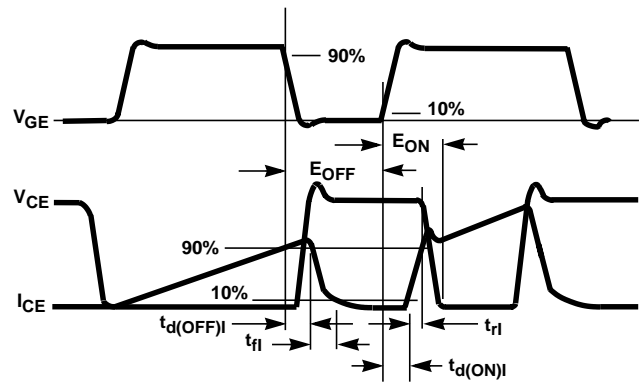

FIGURE 21. SWITCHING TEST WAVEFORMS

Handling Precautions for IGBTs

Insulated Gate Bipolar Transistors are susceptible to gate-insulation damage by the electrostatic discharge of energy through the devices. When handling these devices, care should be exercised to assure that the static charge built in the handler's body capacitance is not discharged through the device. With proper handling and application procedures, however, IGBTs are currently being extensively used in production by numerous equipment manufacturers in military, industrial and consumer applications, with virtually no damage problems due to electrostatic discharge. IGBTs can be handled safely if the following basic precautions are taken:

1. Prior to assembly into a circuit, all leads should be kept shorted together either by the use of metal shorting springs or by the insertion into conductive material such as "ECCOSORBD™ LD26" or equivalent.
2. When devices are removed by hand from their carriers, the hand being used should be grounded by any suitable means - for example, with a metallic wristband.
3. Tips of soldering irons should be grounded.
4. Devices should never be inserted into or removed from circuits with power on.
5. **Gate Voltage Rating** - Never exceed the gate-voltage rating of V_{GEM} . Exceeding the rated V_{GE} can result in permanent damage to the oxide layer in the gate region.
6. **Gate Termination** - The gates of these devices are essentially capacitors. Circuits that leave the gate open-circuited or floating should be avoided. These conditions can result in turn-on of the device due to voltage buildup on the input capacitor due to leakage currents or pickup.
7. **Gate Protection** - These devices do not have an internal monolithic Zener diode from gate to emitter. If gate protection is required an external Zener is recommended.

All Intersil semiconductor products are manufactured, assembled and tested under **ISO9000** quality systems certification.

Intersil semiconductor products are sold by description only. Intersil Corporation reserves the right to make changes in circuit design and/or specifications at any time without notice. Accordingly, the reader is cautioned to verify that data sheets are current before placing orders. Information furnished by Intersil is believed to be accurate and reliable. However, no responsibility is assumed by Intersil or its subsidiaries for its use; nor for any infringements of patents or other rights of third parties which may result from its use. No license is granted by implication or otherwise under any patent or patent rights of Intersil or its subsidiaries.

For information regarding Intersil Corporation and its products, see web site www.intersil.com

Operating Frequency Information

Operating frequency information for a typical device (Figure 3) is presented as a guide for estimating device performance for a specific application. Other typical frequency vs collector current (I_{CE}) plots are possible using the information shown for a typical unit in Figures 5, 6, 7, 8, 9 and 11. The operating frequency plot (Figure 3) of a typical device shows f_{MAX1} or f_{MAX2} ; whichever is smaller at each point. The information is based on measurements of a typical device and is bounded by the maximum rated junction temperature.

f_{MAX1} is defined by $f_{MAX1} = 0.05 / (t_{d(OFF)I} + t_{d(ON)I})$. Deadtime (the denominator) has been arbitrarily held to 10% of the on-state time for a 50% duty factor. Other definitions are possible. $t_{d(OFF)I}$ and $t_{d(ON)I}$ are defined in Figure 21. Device turn-off delay can establish an additional frequency limiting condition for an application other than T_{JM} . $t_{d(OFF)I}$ is important when controlling output ripple under a lightly loaded condition.

f_{MAX2} is defined by $f_{MAX2} = (P_D - P_C) / (E_{OFF} + E_{ON})$. The allowable dissipation (P_D) is defined by $P_D = (T_{JM} - T_C) / R_{\theta JC}$. The sum of device switching and conduction losses must not exceed P_D . A 50% duty factor was used (Figure 3) and the conduction losses (P_C) are approximated by $P_C = (V_{CE} \times I_{CE}) / 2$.

E_{ON} and E_{OFF} are defined in the switching waveforms shown in Figure 21. E_{ON} is the integral of the instantaneous power loss ($I_{CE} \times V_{CE}$) during turn-on and E_{OFF} is the integral of the instantaneous power loss ($I_{CE} \times V_{CE}$) during turn-off. All tail losses are included in the calculation for E_{OFF} ; i.e., the collector current equals zero ($I_{CE} = 0$).