

Photon Coupled Isolator H11V1, H11V2, H11V3

T-41-89

GaAlAs Infrared Emitting Diode & Silicon Integrated Circuit Video Signal Amplifier

The GE Solid State H11V series consists of a high speed Ga Al As infrared emitting diode coupled across a glass isolating medium to a photosensitive, high frequency, linear integrated circuit amplifier. The input and output are matched to optimize video linearity at minimum quiescent power. These devices are mounted in dual-in-line packages. These devices are also available in Surface-Mount packaging.

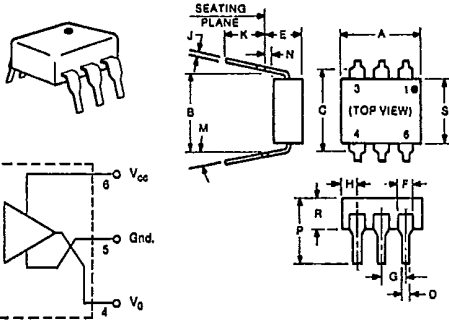

FEATURES

- High gain, typical transimpedance, 1000Ω
- Low input current requirement, typical 3.5mA at 1.6V
- 0 to 10MHz operating bandwidth
- 100mA peak output drive capability

ABSOLUTE MAXIMUM RATINGS (25°C)

Infrared Emitting Diode	
Power Dissipation	50mW*
Forward Current	30mA
Reverse Voltage	6V
*Derate 1.67mW/°C above 70°C ambient	

Integrated Circuit Detector	
Power Dissipation	150mW**
V _{IS} allowed range	0 to 16V
V _{OS} allowed range	0 to 16V
Output Current	50mA
**Derate 5.0mW per °C above 70°C	

Total Device	
Storage Temperature:	-40°C to +100°C
Operating Temperature:	-25°C to +80°C
Lead Solder Temperature:	(≤10sec) 260°C
Surge Isolation Voltage:	4000 VRMS
Steady State Isolation Voltage:	3750 VRMS

SYMBOL	MILLIMETERS		INCHES		NOTES
	MIN.	MAX.	MIN.	MAX.	
A	8.18	8.89	.320	.350	1
B	7.62 REF.		.300 REF.		
C	—	8.64	—	.340	2
D	.406	.508	0.16	.020	
E	—	5.08	—	.200	3
F	1.01	1.78	.040	.070	
G	2.28	2.80	.090	.110	4
H	—	2.16	—	.085	
J	.203	.305	.008	.012	4
K	2.54	—	.100	—	
M	—	15°	—	15°	4
N	.381	—	.015	—	
P	—	9.53	—	.375	4
R	2.92	3.43	.115	.135	
S	6.10	6.86	.240	.270	4

- NOTES
 1. INSTALLED POSITION LEAD CENTERS.
 2. OVERALL INSTALLED DIMENSION.
 3. THESE MEASUREMENTS ARE MADE FROM THE SEATING PLANE.
 4. FOUR PLACES.

INDIVIDUAL ELECTRICAL CHARACTERISTICS (25°C)

Infrared Emitting Diode	Min.	Typ.	Max.	Units
Forward voltage (I _F = 5mA)	1.2	1.5	2.0	V
Dynamic Resistance (I _F = 5mA)	—	10	—	Ω
Reverse Current (V _R = 5V)	—	—	10	μA
Capacitance (V _R = 0V, 1MHz)	—	60	—	pF

Infrared Circuit Detector	Min.	Typ.	Max.	Units
Operating Voltage Range	5	10	15	V
Supply Current (V _{CC} = 10V, R _L = ∞, I _F = 0)	—	6.0	—	mA
Output Voltage (V _{CC} = 10V, R _L = 390Ω, I _F = 0)	0.25	0.75	1.50	V

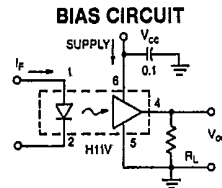

COUPLED ELECTRICAL CHARACTERISTICS (25°C) (V _{CC} = 10V, R _L = 390Ω, Bias Ckt.)	Min.	Typ.	Max.	Units
D.C. Output Voltage (I _F = 3.5 mA)	2.0	4.0	7.0	V
A.C. Output Voltage (I _F = 3.5 mA, i _F = 1mA pk-pk, 1KHz)	H11V1: 0.50	0.90	1.25	Vpk-pk
	H11V2: 0.75	1.00	—	Vpk-pk
	H11V3: 0.33	0.80	—	Vpk-pk
Dynamic Output Impedance (I _F = 3.5 mA, i _F = 1mA pk-pk, 1KHz)	—	15	—	Ω
Supply Current (I _F = 10 mA)	—	30	—	mA
6db Down High Frequency (I _F = 3.5 mA, i _F = 1mA pk-pk)	—	10	—	MHz
Short Circuit Output Current (I _F = 10 mA)	—	.100	—	mA
Isolation Capacitance (V _{IO} = 0, f = 1MHz)	—	0.8	2.0	pF
Isolation Resistance (V _{IO} = 500V)	100	—	—	GΩ

Covered under U.L. Component Recognition Program File E51868

VDE approved to 0883/6.80 0110b

TYPICAL CHARACTERISTICS

...S... HAS

T-4-89

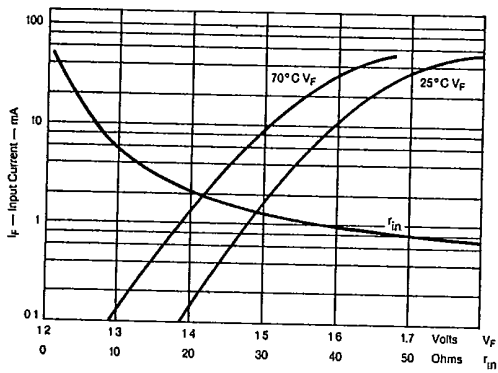

H11V INPUT CHARACTERISTICS

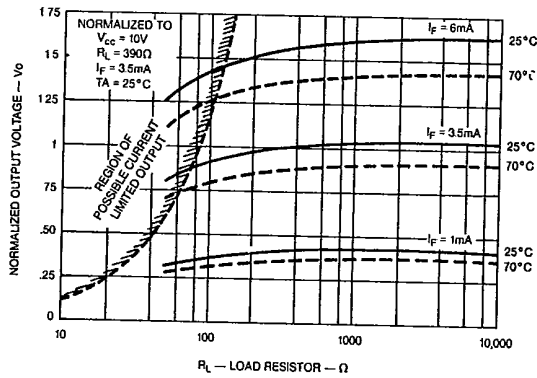

H11V OUTPUT VOLTAGE vs. LOAD RESISTOR

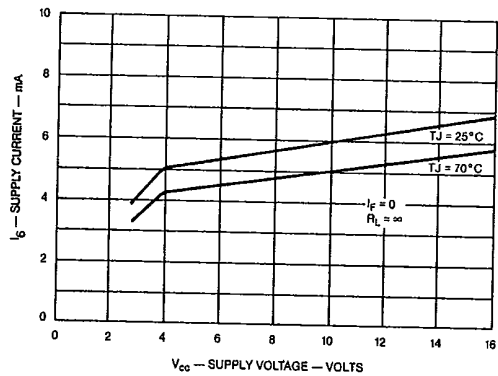

H11V SUPPLY CURRENT vs. SUPPLY VOLTAGE

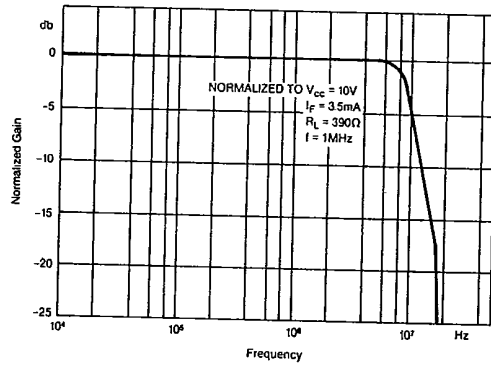

H11V GAIN ROLLOFF

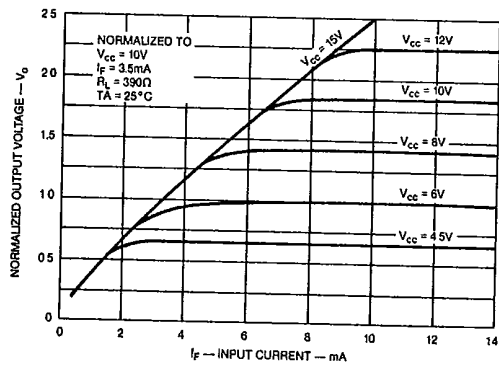

H11V TRANSFER CHARACTERISTICS

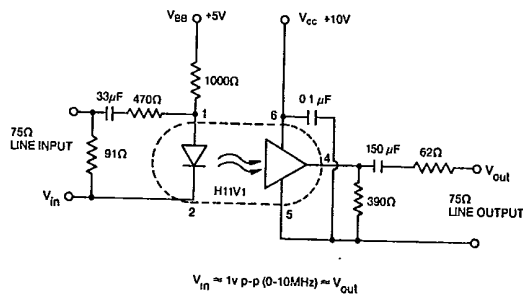

TYPICAL VIDEO COMPOSITE COUPLING CIRCUIT

Surface-Mount Optoisolators

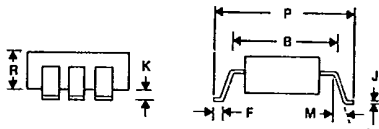
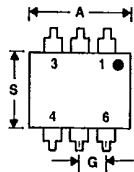

Surface-mount packaging for the entire 6-pin DIP optoisolator line!

Add the "SMA" or "SMB" suffix to any 6-pin optoisolator part number when ordering.

DIMENSIONAL OUTLINE NO. 298
All Surface-Mount Types

SMB (Standard) Surface-Mount Package

SYMBOL	INCHES		MILLIMETERS		NOTES
	MIN.	MAX.	MIN.	MAX.	
A	0.330	0.350	8.38	8.89	
B	0.330 REF		8.38 REF		
F	0.020	0.040	0.508	1.02	
J	0.008	0.012	0.203	0.305	
K	0.0040	0.0098	0.102	0.249	
M	—	15°	—	15°	
P	0.375	0.395	9.53	10.03	
R	0.115	0.135	2.92	3.43	
S	0.240	0.270	6.10	6.86	
Coplanarity	0	0.002	0	0.051	1

92CS-42862

1. Coplanarity is the distance from a plane, defined by the end of the three longest legs to the end of the shortest leg.

SMA (Low Profile) Surface-Mount Package

SYMBOL	INCHES		MILLIMETERS		NOTES
	MIN.	MAX.	MIN.	MAX.	
A	0.330	0.350	8.38	8.89	
B	0.330 REF		8.38 REF		
F	0.020	0.040	0.508	1.02	
J	0.008	0.012	0.203	0.305	
K	0.0005	0.0040	0.013	0.102	
M	—	15°	—	15°	
P	0.373	0.393	9.47	9.98	
R	0.115	0.135	2.92	3.43	
S	0.240	0.270	6.10	6.86	
Coplanarity	0	0.002	0	0.051	1

92CS-42861

1. Coplanarity is the distance from a plane, defined by the end of the three longest legs to the end of the shortest leg.

