

IGBT with Diode

IXSK 50N60AU1

$$V_{CES} = 600 \text{ V}$$

$$I_{C25} = 75 \text{ A}$$

$$V_{CE(sat)} = 2.7 \text{ V}$$

Combi Pack

Short Circuit SOA Capability

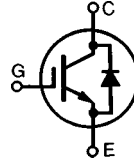

Symbol	Test Conditions	Maximum Ratings	
V_{CES}	$T_J = 25^\circ\text{C}$ to 150°C	600	V
V_{CGR}	$T_J = 25^\circ\text{C}$ to 150°C ; $R_{GE} = 1 \text{ M}\Omega$	600	V
V_{GES}	Continuous	± 20	V
V_{GEM}	Transient	± 30	V
I_{C25}	$T_C = 25^\circ\text{C}$, limited by leads	75	A
I_{C90}	$T_C = 90^\circ\text{C}$	50	A
I_{CM}	$T_C = 25^\circ\text{C}$, 1 ms	200	A
SSOA (RBSOA)	$V_{GE} = 15 \text{ V}$, $T_{VJ} = 125^\circ\text{C}$, $R_G = 22 \Omega$ Clamped inductive load, $L = 30 \mu\text{H}$	$I_{CM} = 100$ @ $0.8 V_{CES}$	A
t_{SC} (SCSOA)	$V_{GE} = 15 \text{ V}$, $V_{CE} = 360 \text{ V}$, $T_J = 125^\circ\text{C}$ $R_G = 22 \Omega$, non repetitive	10	μs
P_c	$T_C = 25^\circ\text{C}$	300	W
T_J		-55 ... +150	$^\circ\text{C}$
T_{JM}		150	$^\circ\text{C}$
T_{stg}		-55 ... +150	$^\circ\text{C}$
M_d	Mounting torque	0.9/6	Nm/lb.in.
Weight		10	g
Maximum lead temperature for soldering 1.6 mm (0.062 in.) from case for 10 s		300	$^\circ\text{C}$

TO-264 AA

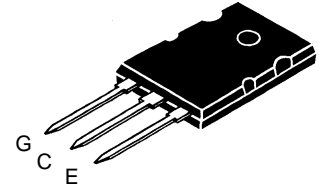

G = Gate, C = Collector,
E = Emitter, TAB = Collector

Features

- International standard package JEDEC TO-264 AA
- Guaranteed Short Circuit SOA capability
- High frequency IGBT and anti-parallel FRED in one package
- 2nd generation HDMOS™ process
- Low $V_{CE(sat)}$
 - for minimum on-state conduction losses
- MOS Gate turn-on
 - drive simplicity
- Fast Recovery Epitaxial Diode (FRED)
 - soft recovery with low I_{RM}

Applications

- AC motor speed control
- DC servo and robot drives
- DC choppers
- Uninterruptible power supplies (UPS)
- Switch-mode and resonant-mode power supplies

Advantages

- Space savings (two devices in one package)
- Easy to mount with 1 screw (isolated mounting screw hole)
- Reduces assembly time and cost

Symbol	Test Conditions	Characteristic Values ($T_J = 25^\circ\text{C}$, unless otherwise specified)		
		min.	typ.	max.
BV_{CES}	$I_C = 3 \text{ mA}$, $V_{GE} = 0 \text{ V}$	600		V
$V_{GE(th)}$	$I_C = 4 \text{ mA}$, $V_{CE} = V_{GE}$	4		V
I_{CES}	$V_{CE} = 0.8 \cdot V_{CES}$, $T_J = 25^\circ\text{C}$ $V_{GE} = 0 \text{ V}$, $T_J = 125^\circ\text{C}$			750 μA 15 mA
I_{GES}	$V_{CE} = 0 \text{ V}$, $V_{GE} = \pm 20 \text{ V}$			$\pm 100 \text{ nA}$
$V_{CE(sat)}$	$I_C = I_{C90}$, $V_{GE} = 15 \text{ V}$			2.7 V

IXYS reserves the right to change limits, test conditions and dimensions.

© IXYS Corporation. All rights reserved.

92822G (4/96)

Symbol	Test Conditions	Characteristic Values ($T_J = 25^\circ\text{C}$, unless otherwise specified)		
		min.	typ.	max.
g_{fs}	$I_C = I_{C90}$; $V_{CE} = 10\text{ V}$, Pulse test, $t \leq 300\ \mu\text{s}$, duty cycle $\leq 2\%$	20	23	S
Q_g	$I_C = I_{C90}$, $V_{GE} = 15\text{ V}$, $V_{CE} = 0.5\ V_{CES}$		190	250 nC
Q_{ge}			45	60 nC
Q_{gc}			88	120 nC
$t_{d(on)}$	Inductive load, $T_J = 25^\circ\text{C}$ $I_C = I_{C90}$, $V_{GE} = 15\text{ V}$, $L = 100\ \mu\text{H}$, $V_{CE} = 0.8\ V_{CES}$, $R_G = 2.7\ \Omega$ Remarks: Switching times may increase for V_{CE} (Clamp) $> 0.8 \cdot V_{CES}$, higher T_J or increased R_G		70	ns
t_{ri}			220	ns
$t_{d(off)}$			200	ns
t_{fi}			400	600 ns
E_{off}			6	mJ
$t_{d(on)}$	Inductive load, $T_J = 125^\circ\text{C}$ $I_C = I_{C90}$, $V_{GE} = 15\text{ V}$, $L = 100\ \mu\text{H}$ $V_{CE} = 0.8\ V_{CES}$, $R_G = 2.7\ \Omega$ Remarks: Switching times may increase for V_{CE} (Clamp) $> 0.8 \cdot V_{CES}$, higher T_J or increased R_G		70	ns
t_{ri}			230	ns
E_{on}			4.5	mJ
$t_{d(off)}$			340	ns
t_{fi}			400	ns
E_{off}		7	mJ	
R_{thJC}				0.42 K/W
R_{thCK}		0.15		K/W

Symbol	Test Conditions	Characteristic Values ($T_J = 25^\circ\text{C}$, unless otherwise specified)		
		min.	typ.	max.
V_F	$I_F = I_{C90}$, $V_{GE} = 0\text{ V}$, Pulse test, $t \leq 300\ \mu\text{s}$, duty cycle $d \leq 2\%$			1.8 V
I_{RM}	$I_F = I_{C90}$, $V_{GE} = 0\text{ V}$, $-di_F/dt = 480\text{ A}/\mu\text{s}$ $V_R = 360\text{ V}$ $T_J = 125^\circ\text{C}$ $I_F = 1\text{ A}$; $-di/dt = 200\text{ A}/\mu\text{s}$; $V_R = 30\text{ V}$ $T_J = 25^\circ\text{C}$		19	33 A
t_{tr}			175	ns
			35	50 ns
R_{thJC}				0.75 K/W

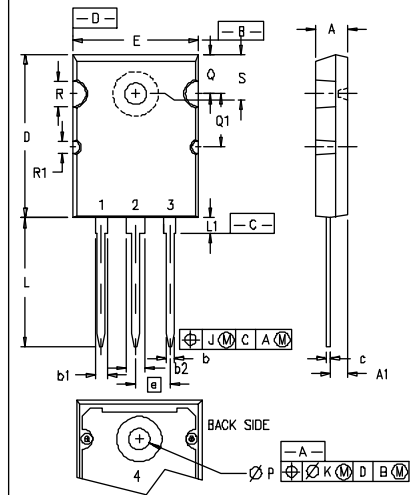
TO-264 AA Outline

SYM	INCHES		MILLIMETERS	
	MIN	MAX	MIN	MAX
A	.185	.209	4.70	5.31
A1	.102	.118	2.59	3.00
b	.037	.055	0.94	1.40
b1	.087	.102	2.21	2.59
b2	.110	.126	2.79	3.20
c	.017	.029	0.43	0.74
D	1.007	1.047	25.58	26.59
E	.760	.799	19.30	20.29
e	.215 BSC		5.46 BSC	
J	.000	.010	0.00	0.25
K	.000	.010	0.00	0.25
L	.779	.842	19.79	21.39
L1	.087	.102	2.21	2.59
$\varnothing P$.122	.138	3.10	3.51
Q	.240	.256	6.10	6.50
Q1	.330	.346	8.38	8.79
$\varnothing R$.155	.187	3.94	4.75
$\varnothing R1$.085	.093	2.16	2.36
S	.243	.253	6.17	6.43

- 1 - GATE
- 2, 4 - DRAIN (COLLECTOR)
- 3 - SOURCE (EMITTER)

IXYS MOSFETs and IGBTs are covered by one of the following U.S.patents: 4,835,592 4,881,108 5,017,508 5,049,961 5,187,117 5,486,715
4,850,072 4,931,844 5,034,796 5,063,307 5,237,481 5,381,025

IXYS reserves the right to change limits, test conditions, and dimensions.

IXYS Corporation
3540 Bassett Street, Santa Clara CA 95054

IXYS Semiconductor GmbH
Edisonstr. 15, D-68623 Lampertheim
Phone: +49-6206-503-0, Fax: +49-6206-503627

Fig. 1 Saturation Characteristics

Fig. 2 Output Characteristics

Fig. 3 Collector-Emitter Voltage vs. Gate-Emitter Voltage

Fig. 4 Temperature Dependence of Output Saturation Voltage

Fig. 5 Input Admittance

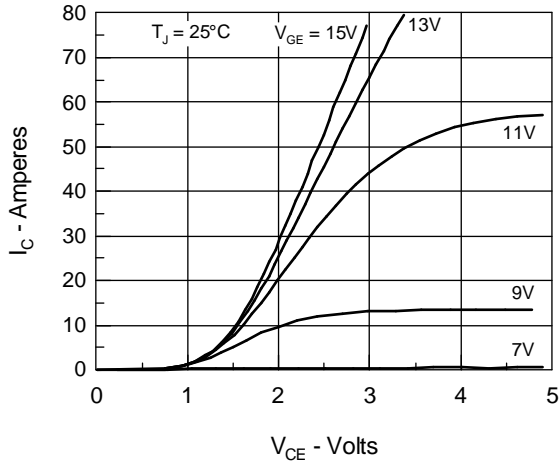
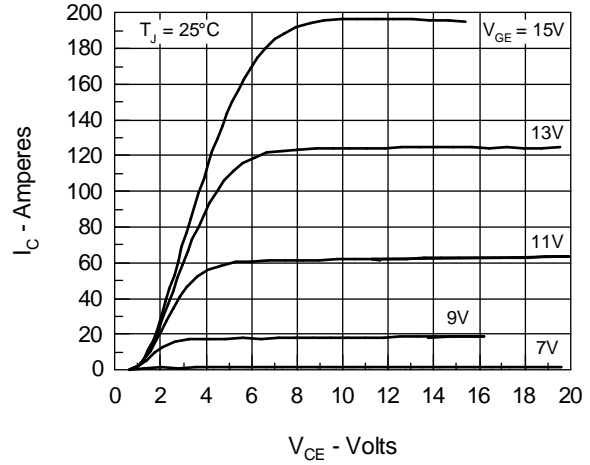
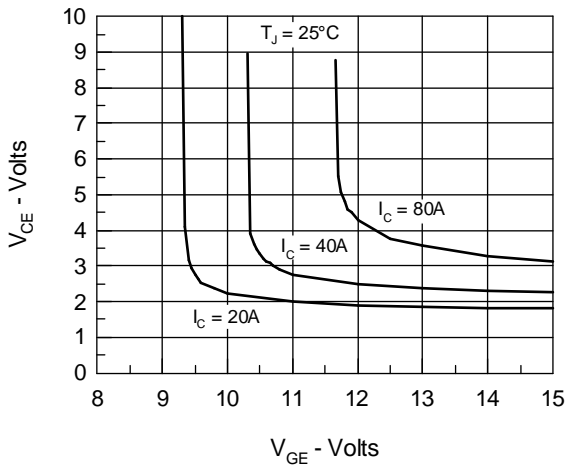
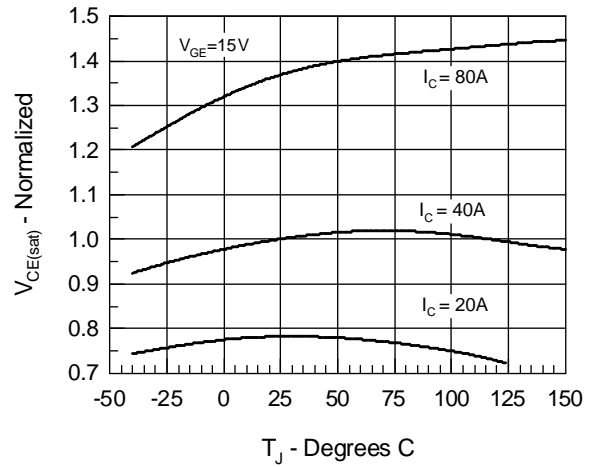
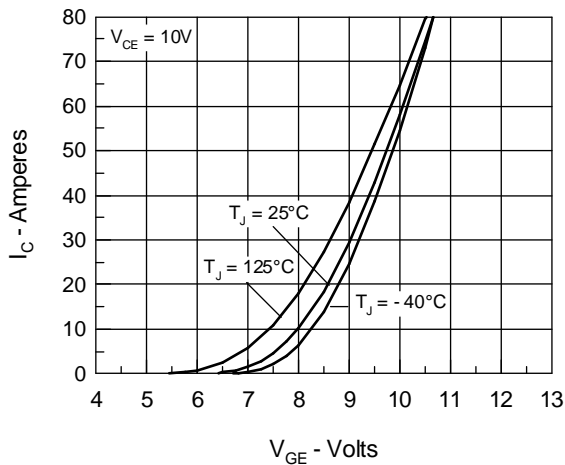
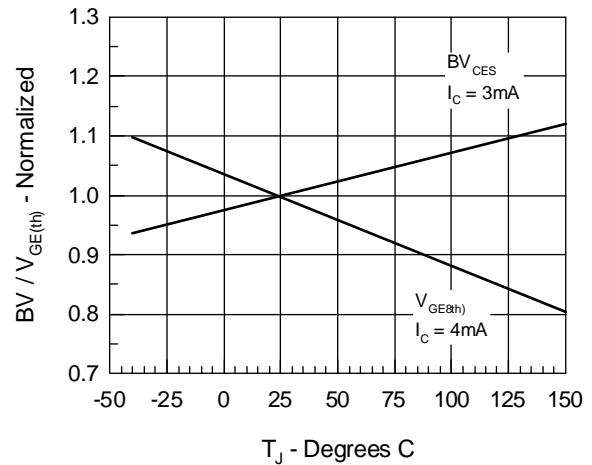
Fig. 6 Temperature Dependence of Breakdown and Threshold Voltage

Fig.7 Turn-Off Energy per Pulse and Fall Time on Collector Current

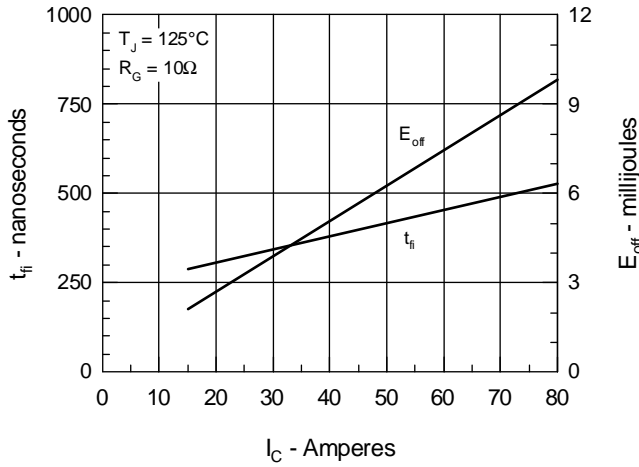

Fig.8 Dependence of Turn-Off Energy Per Pulse and Fall Time on R_G

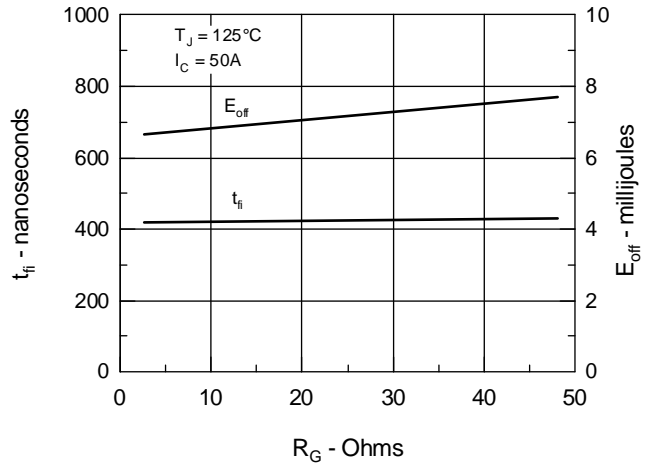

Fig.9 Gate Charge Characteristic Curve

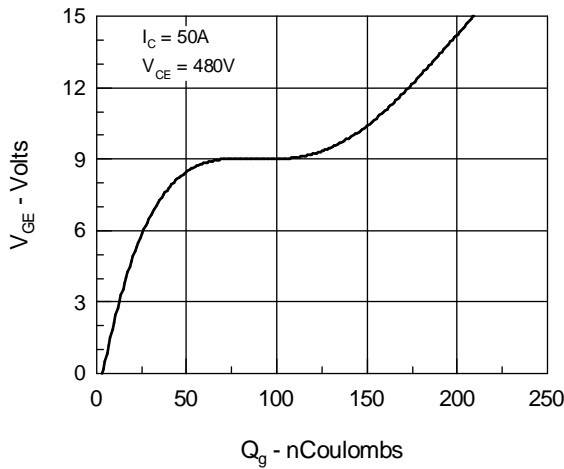

Fig.10 Turn-Off Safe Operating Area

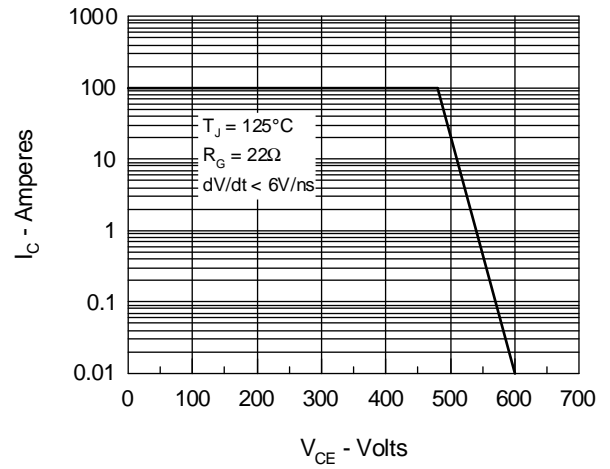
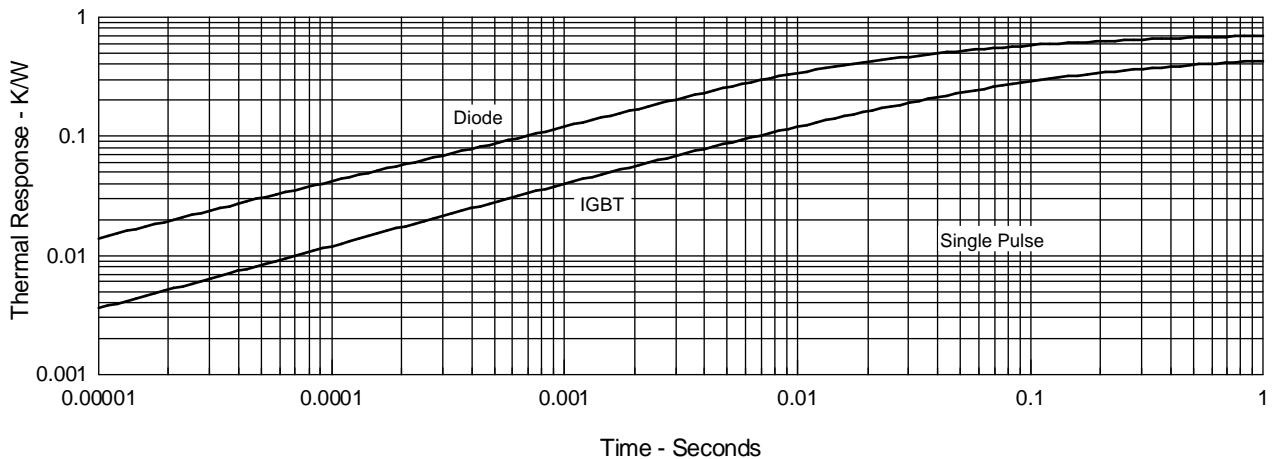

Fig.11 Transient Thermal Impedance



IXYS reserves the right to change limits, test conditions, and dimensions.

Fig.12 Typical Forward Voltage Drop

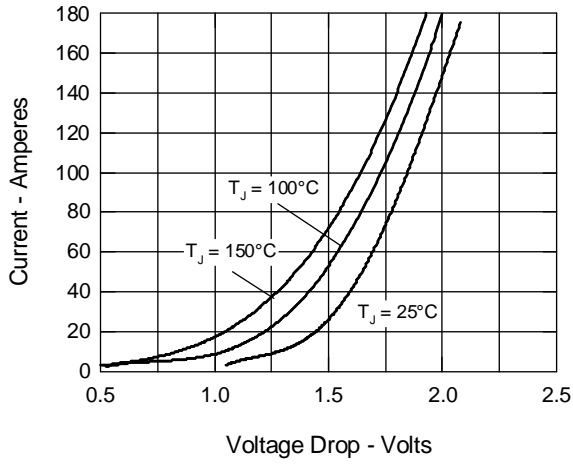

Fig.13 Peak Forward Voltage V_{FR} and Forward Recovery Time t_{fr}

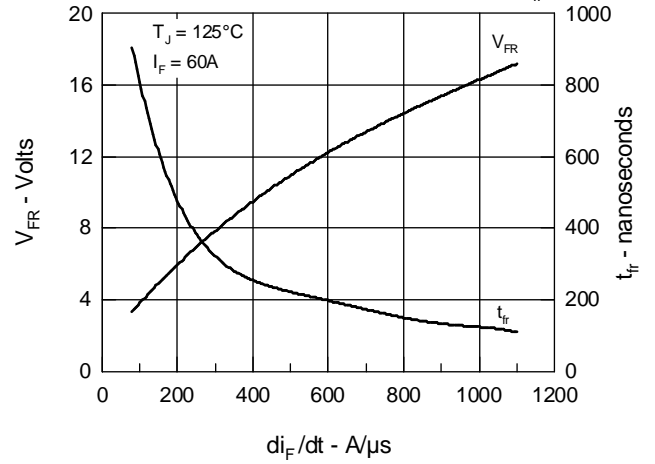

Fig.14 Junction Temperature Dependence of I_{RM} and Q_r

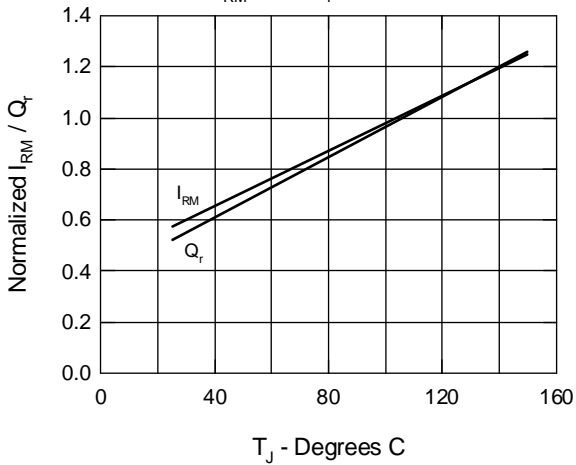

Fig.15 Reverse Recovery Charge

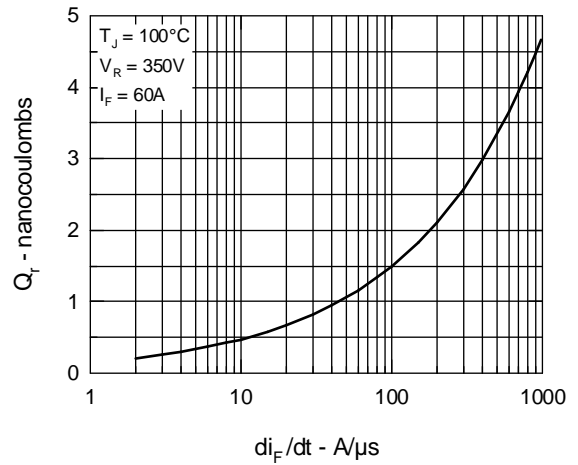

Fig.16 Peak Reverse Recovery Current

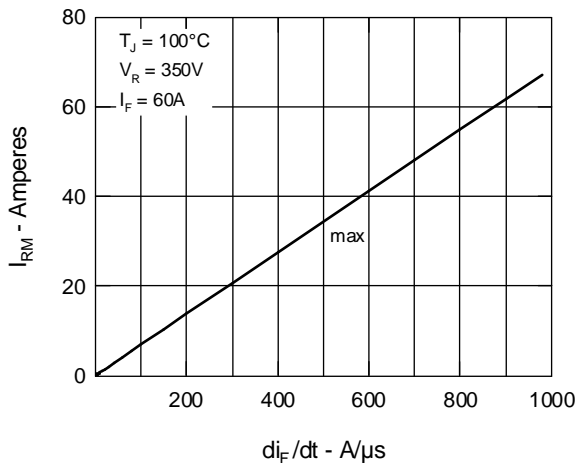
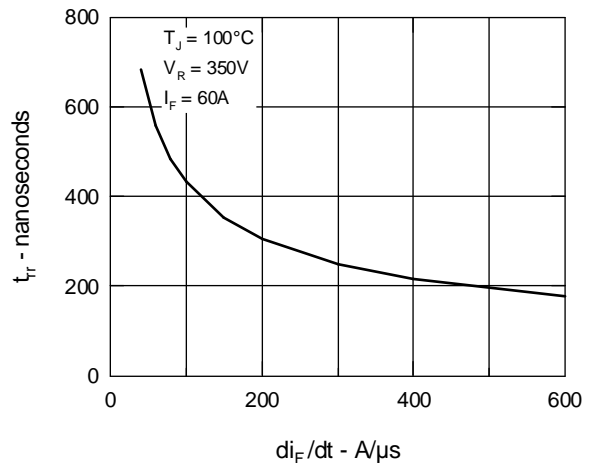

Fig.17 Reverse Recovery Time



IXYS reserves the right to change limits, test conditions, and dimensions.

IXYS Corporation
3540 Bassett Street, Santa Clara CA 95054
Phone: 408-982-0700, Fax: 408-496-0670

IXYS Semiconductor GmbH
Edisonstr. 15, D-68623 Lampertheim
Phone: +49-6206-503-0, Fax: +49-6206-503627