

5V Crystal Clock Oscillators

- 4-pin Package, Compatible with 14-pin DIL
- 40 to 160MHz Frequency Range (Discrete Higher Frequencies Available)
- Designed to Drive Standard ECL 10K and 10KH Families
- ECL and PECL Options Available
- Dual Complementary Output Available
- 50Ω Drive Capability
- Internal 470W Output Pull-Down Resistor Available

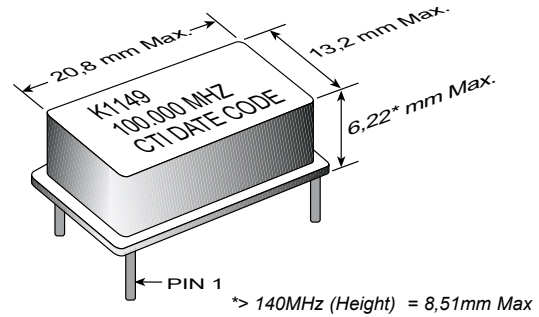

ELECTRICAL SPECIFICATIONS

MODEL	See Part Numbering Guide Below
Frequency Range (MHz)	40 to 160
Higher Frequency Available (MHz)	180, 200, 220
Frequency Stability (ppm)	
Overall	Inclusive of calibration, temperature, voltage, load, shock, vibration, aging
0°C to 70°C	±100
Temperature Range (°C)	
Operating	0°C to +70°C
Storage	-55°C to +125°C
Supply Voltage (V)	
ECL (V_{EE})	-5.2 ± 5%
PECL (V_{CC})	+5.0 ± 5%
Supply Current (mA)	
Typical	28; 55 on R-Suffix (Option 3)
Maximum	60; 90 on R-Suffix (Option 3)
Jitter (Typical)	5ps RMS @ 40MHz
Start up Time (ms)	<10

PART NUMBERING GUIDE (Use this chart for ordering)

PIN	K1149AA	K1149AB	K1149AC	K1149AM	K1149BA	K1149BC	K1149BM	K1149CA
1	Case GND	Case GND	N/C	N/C	Comp. Out	Comp Out	Comp Out	N/C
7	V_{EE}	V_{SS}	V_{EE}	V_{SS} & Case GND	V_{SS} & Case GND	V_{EE}	V_{SS} & Case GND	V_{EE} & Case GND
8	ECL Out	ECL Out	ECL Out	ECL Out	PECL Out	ECL Out	ECL Out	PECL Out
14	V_{SS}	V_{EE}	V_{SS} & Case GND	V_{EE}	V_{CC}	V_{SS} & Case GND	V_{EE}	V_{CC}
Frequency (MHz)	40 to 125			40 to 160				
Option	1, 2, 3			2, 3				
Options Available								
1. Optional +5.0 ± 10% Operation at V_{SS}								
2. 50ppm (K1149XX5 available only in frequency range of 40MHz to 160MHz)								
3. Optional internal pull down resistor available only in the range of 40MHz to 160MHz - K1149XX-R								

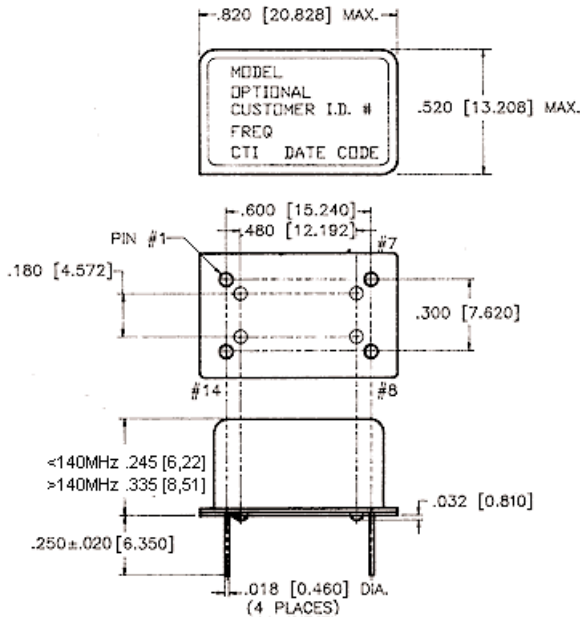

TEST CIRCUIT DIAGRAM

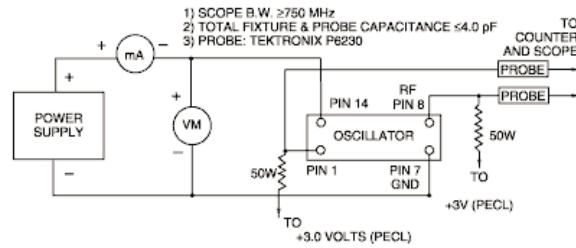

OUTPUT WAVEFORM

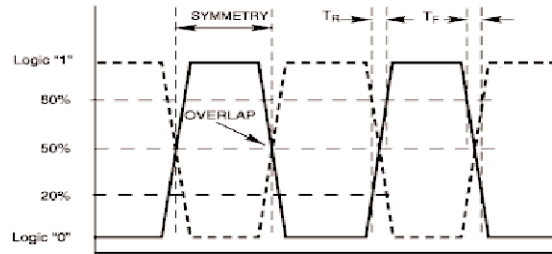

Parameter	Symbol	Units	ECL			PECL				
			Test Condition	Min.	Typ.	Max.	Test Condition	Min.	Typ.	Max.
Ground Reference	V _{SS}	Volts	Reference		0		Reference		0	
Power Supply (ECL)	V _{EE}	Volts	Reference		-5.2		N/A			
Power Supply (PECL)	V _{CC}	Volts	N/A		-		Reference	4.75	5.0	5.25
"0" Level	V _{OL}	Volts	50Ω into V _{SS} -2	V _{SS} -1.95		V _{SS} -1.6	50Ω into V _{CC} -2	V _{CC} -1.95		V _{CC} -1.6
"1" Level	V _{OH}	Volts	50Ω into V _{SS} -2	V _{SS} -1.02		V _{SS} -0.74	50Ω into V _{CC} -2	V _{CC} -1.02		V _{CC} -1.74
Rise Time	T _R	ps	50Ω into, 20% to 80%		1.0	2.0	50Ω into, 20% to 80%		1.0	2.0
Fall Time	T _F	ps	50Ω into, 20% to 80%		1.0	2.0	50Ω into, 80% to 20%		1.0	2.0
Overlap	T _{OL}	ps	50%			1.0	50%			1.0
Symmetry	S	%	V _{SS} -1.3	40		60	V _{CC} -1.3	40		60

MECHANICAL AND ENVIRONMENTAL SPECIFICATIONS

TEST METHODS	REFERENCE PROCEDURES	DESCRIPTION
Temperature Cycle	MIL-STD-883, Mtd 1010, Cond. B	-55°C to +125°C; Air-to-Air; 100 cycles; 10 min. dwell
Mechanical Shock	MIL-STD-883, Mtd 2002, Cond. B	1500 g's
Vibration	MIL-STD 883, Mtd 2007, Cond. B	20-2000 Hz; 0.06 inch; 15g's; 3 planes
Humidity Steady State	MIL-STD-202, Mtd 103	40°C; 90%-95% R.H.; 56 days
Thermal Shock	MIL-STD-883, Mtd 1011.7 Cond. B	100°C to 0°C; Water-to-Water; 15 cycles
Electrostatic Discharge	MIL-STD-883, Mtd 3015 Class II	2 KV to 4 KV Threshold
Solderability	MIL-STD-883, Mtd 2022.2	Solder dip; Meniscograph Criteria
Hermeticity	MIL-STD-883, Mtd 1014.8, Cond. A1	Mass spectro. 2 x 10 ⁻⁸ atmos. CC/sec He
Resistance to Soldering	MIL-STD-202, Mtd 210D, Cond. J	235°C; 30 seconds
Lead Integrity	MIL-STD-883, Mtd 2004.5, Cond. A, B1	Lead tension & bend stress
Marking Permanence	MIL-STD-883, Mtd 2015.8	Resistance to solvents
Life Test	MIL-STD-883, Mtd 1005.6	125°C, powered, 1000 hours minimum