

LM3045/LM3046/LM3086 Transistor Arrays

General Description

The LM3045, LM3046 and LM3086 each consist of five general purpose silicon NPN transistors on a common monolithic substrate. Two of the transistors are internally connected to form a differentially-connected pair. The transistors are well suited to a wide variety of applications in low power system in the DC through VHF range. They may be used as discrete transistors in conventional circuits however, in addition, they provide the very significant inherent integrated circuit advantages of close electrical and thermal matching. The LM3045 is supplied in a 14-lead cavity dual-in-line package rated for operation over the full military temperature range. The LM3046 and LM3086 are electrically identical to the LM3045 but are supplied in a 14-lead molded dual-in-line package for applications requiring only a limited temperature range.

Features

- Two matched pairs of transistors
 V_{BE} matched ± 5 mV
 Input offset current $2 \mu\text{A}$ max at $I_C = 1$ mA
- Five general purpose monolithic transistors
- Operation from DC to 120 MHz
- Wide operating current range
- Low noise figure 3.2 dB typ at 1 kHz
- Full military temperature range (LM3045) -55°C to $+125^\circ\text{C}$

Applications

- General use in all types of signal processing systems operating anywhere in the frequency range from DC to VHF
- Custom designed differential amplifiers
- Temperature compensated amplifiers

Schematic and Connection Diagram

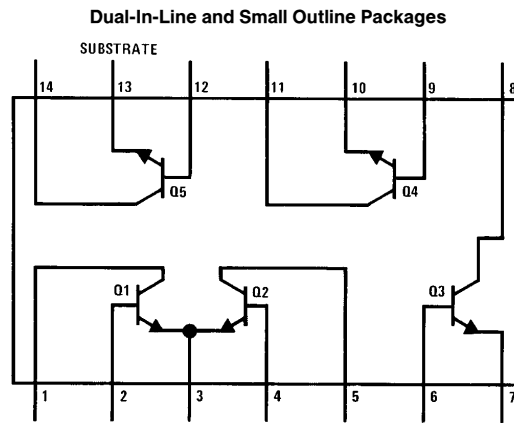

TL/H/7950-1

Top View

Order Number LM3045J, LM3046M, LM3046N or LM3086N
 See NS Package Number J14A, M14A or N14A

Absolute Maximum Ratings ($T_A = 25^\circ\text{C}$)

If Military/Aerospace specified devices are required, please contact the National Semiconductor Sales Office/Distributors for availability and specifications.

	LM3045		LM3046/LM3086		Units
	Each Transistor	Total Package	Each Transistor	Total Package	
Power Dissipation:					
$T_A = 25^\circ\text{C}$	300	750	300	750	mW
$T_A = 25^\circ\text{C}$ to 55°C			300	750	mW
$T_A > 55^\circ\text{C}$			Derate at 6.67		mW/ $^\circ\text{C}$
$T_A = 25^\circ\text{C}$ to 75°C	300	750			mW
$T_A > 75^\circ\text{C}$	Derate at 8				mW/ $^\circ\text{C}$
Collector to Emitter Voltage, V_{CE0}	15		15		V
Collector to Base Voltage, V_{CBO}	20		20		V
Collector to Substrate Voltage, V_{CIO} (Note 1)	20		20		V
Emitter to Base Voltage, V_{EBO}	5		5		V
Collector Current, I_C	50		50		mA
Operating Temperature Range	-55°C to $+125^\circ\text{C}$		-40°C to $+85^\circ\text{C}$		
Storage Temperature Range	-65°C to $+150^\circ\text{C}$		-65°C to $+85^\circ\text{C}$		
Soldering Information					
Dual-In-Line Package Soldering (10 Sec.)	260°C		260°C		
Small Outline Package					
Vapor Phase (60 Seconds)			215°C		
Infrared (15 Seconds)			220°C		

See AN-450 "Surface Mounting Methods and Their Effect on Product Reliability" for other methods of soldering surface mount devices.

Electrical Characteristics ($T_A = 25^\circ\text{C}$ unless otherwise specified)

Parameter	Conditions	Limits			Limits			Units
		LM3045, LM3046			LM3086			
		Min	Typ	Max	Min	Typ	Max	
Collector to Base Breakdown Voltage ($V_{(BR)CBO}$)	$I_C = 10 \mu\text{A}$, $I_E = 0$	20	60		20	60		V
Collector to Emitter Breakdown Voltage ($V_{(BR)CEO}$)	$I_C = 1 \text{ mA}$, $I_B = 0$	15	24		15	24		V
Collector to Substrate Breakdown Voltage ($V_{(BR)CIO}$)	$I_C = 10 \mu\text{A}$, $I_{C1} = 0$	20	60		20	60		V
Emitter to Base Breakdown Voltage ($V_{(BR)EBO}$)	$I_E = 10 \mu\text{A}$, $I_C = 0$	5	7		5	7		V
Collector Cutoff Current (I_{CBO})	$V_{CB} = 10\text{V}$, $I_E = 0$		0.002	40		0.002	100	nA
Collector Cutoff Current (I_{CEO})	$V_{CE} = 10\text{V}$, $I_B = 0$			0.5			5	μA
Static Forward Current Transfer Ratio (Static Beta) (h_{FE})	$V_{CE} = 3\text{V}$ $\begin{cases} I_C = 10 \text{ mA} \\ I_C = 1 \text{ mA} \\ I_C = 10 \mu\text{A} \end{cases}$		100			100		
		40	100		40	100		
			54			54		
Input Offset Current for Matched Pair Q_1 and Q_2 $ I_{O1} - I_{O2} $	$V_{CE} = 3\text{V}$, $I_C = 1 \text{ mA}$		0.3	2				μA
Base to Emitter Voltage (V_{BE})	$V_{CE} = 3\text{V}$ $\begin{cases} I_E = 1 \text{ mA} \\ I_E = 10 \text{ mA} \end{cases}$		0.715			0.715		V
			0.800			0.800		
Magnitude of Input Offset Voltage for Differential Pair $ V_{BE1} - V_{BE2} $	$V_{CE} = 3\text{V}$, $I_C = 1 \text{ mA}$		0.45	5				mV
Magnitude of Input Offset Voltage for Isolated Transistors $ V_{BE3} - V_{BE4} $, $ V_{BE4} - V_{BE5} $, $ V_{BE5} - V_{BE3} $	$V_{CE} = 3\text{V}$, $I_C = 1 \text{ mA}$		0.45	5				mV
Temperature Coefficient of Base to Emitter Voltage $\left(\frac{\Delta V_{BE}}{\Delta T}\right)$	$V_{CE} = 3\text{V}$, $I_C = 1 \text{ mA}$		-1.9			-1.9		mV/ $^\circ\text{C}$
Collector to Emitter Saturation Voltage ($V_{CE(SAT)}$)	$I_B = 1 \text{ mA}$, $I_C = 10 \text{ mA}$		0.23			0.23		V
Temperature Coefficient of Input Offset Voltage $\left(\frac{\Delta V_{I0}}{\Delta T}\right)$	$V_{CE} = 3\text{V}$, $I_C = 1 \text{ mA}$		1.1					$\mu\text{V}/^\circ\text{C}$

Note 1: The collector of each transistor of the LM3045, LM3046, and LM3086 is isolated from the substrate by an integral diode. The substrate (terminal 13) must be connected to the most negative point in the external circuit to maintain isolation between transistors and to provide for normal transistor action.

Electrical Characteristics (Continued)

Parameter	Conditions	Min	Typ	Max	Units
Low Frequency Noise Figure (NF)	$f = 1 \text{ kHz}, V_{CE} = 3V,$ $I_C = 100 \mu A, R_S = 1 \text{ k}\Omega$		3.25		dB
LOW FREQUENCY, SMALL SIGNAL EQUIVALENT CIRCUIT CHARACTERISTICS					
Forward Current Transfer Ratio (h_{fe})	$f = 1 \text{ kHz}, V_{CE} = 3V,$ $I_C = 1 \text{ mA}$		110 (LM3045, LM3046) (LM3086)		
Short Circuit Input Impedance (h_{ie})			3.5		$\text{k}\Omega$
Open Circuit Output Impedance (h_{oe})			15.6		μmho
Open Circuit Reverse Voltage Transfer Ratio (h_{re})			1.8×10^{-4}		
ADMITTANCE CHARACTERISTICS					
Forward Transfer Admittance (Y_{fe})	$f = 1 \text{ MHz}, V_{CE} = 3V,$ $I_C = 1 \text{ mA}$		$31 - j 1.5$		
Input Admittance (Y_{ie})			$0.3 + j 0.04$		
Output Admittance (Y_{oe})			$0.001 + j 0.03$		
Reverse Transfer Admittance (Y_{re})			See Curve		
Gain Bandwidth Product (f_T)	$V_{CE} = 3V, I_C = 3 \text{ mA}$	300	550		
Emitter to Base Capacitance (C_{EB})	$V_{EB} = 3V, I_E = 0$		0.6		pF
Collector to Base Capacitance (C_{CB})	$V_{CB} = 3V, I_C = 0$		0.58		pF
Collector to Substrate Capacitance (C_{CI})	$V_{CS} = 3V, I_C = 0$		2.8		pF

Typical Performance Characteristics

Typical Collector To Base Cutoff Current vs Ambient Temperature for Each Transistor

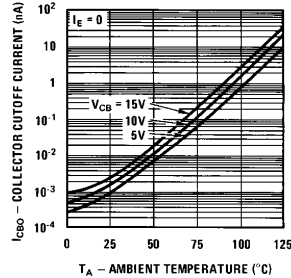

Typical Collector To Emitter Cutoff Current vs Ambient Temperature for Each Transistor

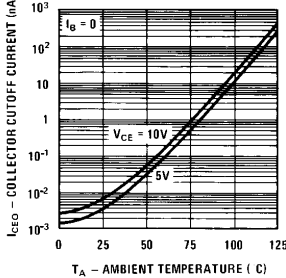

Typical Static Forward Current-Transfer Ratio and Beta Ratio for Transistors Q₁ and Q₂ vs Emitter Current

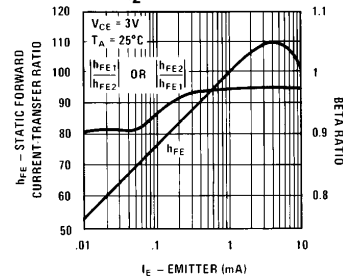

TL/H/7950-2

Typical Input Offset Current for Matched Transistor Pair Q₁ Q₂ vs Collector Current

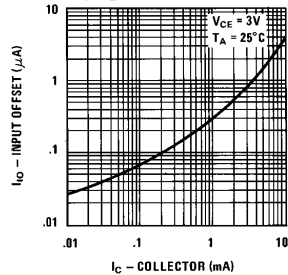

Typical Static Base To Emitter Voltage Characteristic and Input Offset Voltage for Differential Pair and Paired Isolated Transistors vs Emitter Current

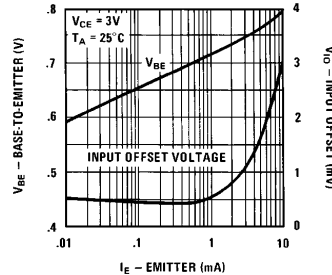

TL/H/7950-3

Typical Performance Characteristics (Continued)

Typical Base To Emitter Voltage Characteristic for Each Transistor vs Ambient Temperature

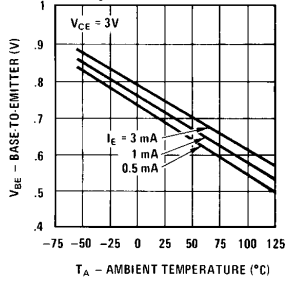

Typical Input Offset Voltage Characteristics for Differential Pair and Paired Isolated Transistors vs Ambient Temperature

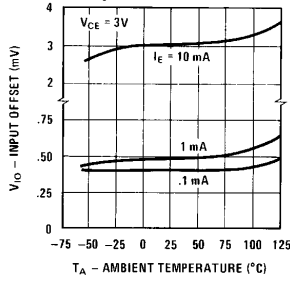

Typical Noise Figure vs Collector Current

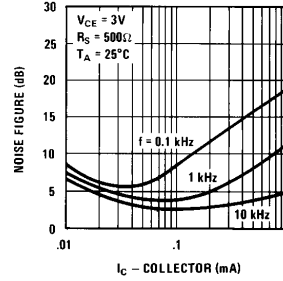

TL/H/7950-4

Typical Noise Figure vs Collector Current

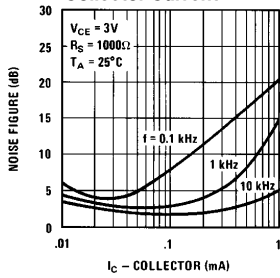

Typical Noise Figure vs Collector Current

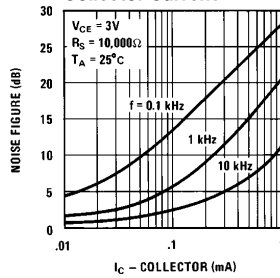

Typical Normalized Forward Current Transfer Ratio, Short Circuit Input Impedance, Open Circuit Output Impedance, and Open Circuit Reverse Voltage Transfer Ratio vs Collector Current

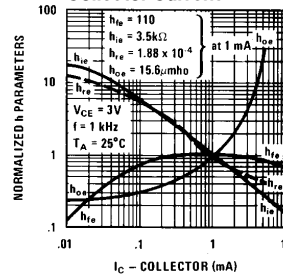

TL/H/7950-5

Typical Forward Transfer Admittance vs Frequency

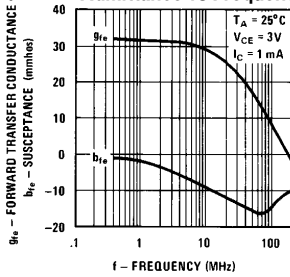

Typical Input Admittance vs Frequency

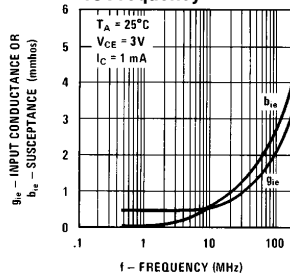

Typical Output Admittance vs Frequency

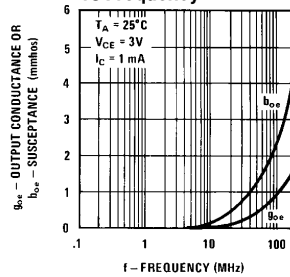

TL/H/7950-6

