

LM306 DIFFERENTIAL COMPARATOR WITH STROBES

SLCS008A – OCTOBER 1979 – REVISED OCTOBER 1991

- Fast Response Times
- Improved Gain and Accuracy
- Fanout to 10 Series 54/74 TTL Loads
- Strobe Capability
- Short-Circuit and Surge Protection
- Designed to Be Interchangeable With National Semiconductor LM306

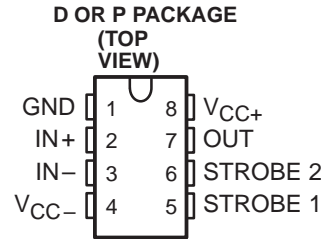

description

The LM306 is a high-speed voltage comparator with differential inputs, a low-impedance high-sink-current (100 mA) output, and two strobe inputs. This device detects low-level analog or digital signals and can drive digital logic or lamps and relays directly. Short-circuit protection and surge-current limiting is provided.

A low-level input at either strobe causes the output to remain high regardless of the differential input. When both strobe inputs are either open or at a high logic level, the output voltage is controlled by the differential input voltage. The circuit will operate with any negative supply voltage between -3 V and -12 V with little difference in performance.

The LM306 is characterized for operation from 0°C to 70°C .

functional block diagram

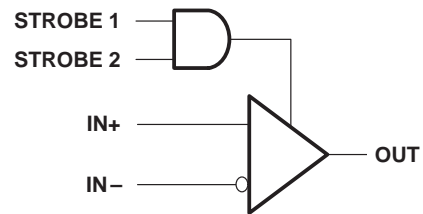

AVAILABLE OPTIONS

T_A	V_{IOmax} at 25°C	PACKAGE	
		SMALL OUTLINE (D)	PLASTIC DIP (P)
0°C to 70°C	5 mV	LM306D	LM306P

LM306 DIFFERENTIAL COMPARATOR WITH STROBES

SLCS008A – OCTOBER 1979 – REVISED OCTOBER 1991

schematic

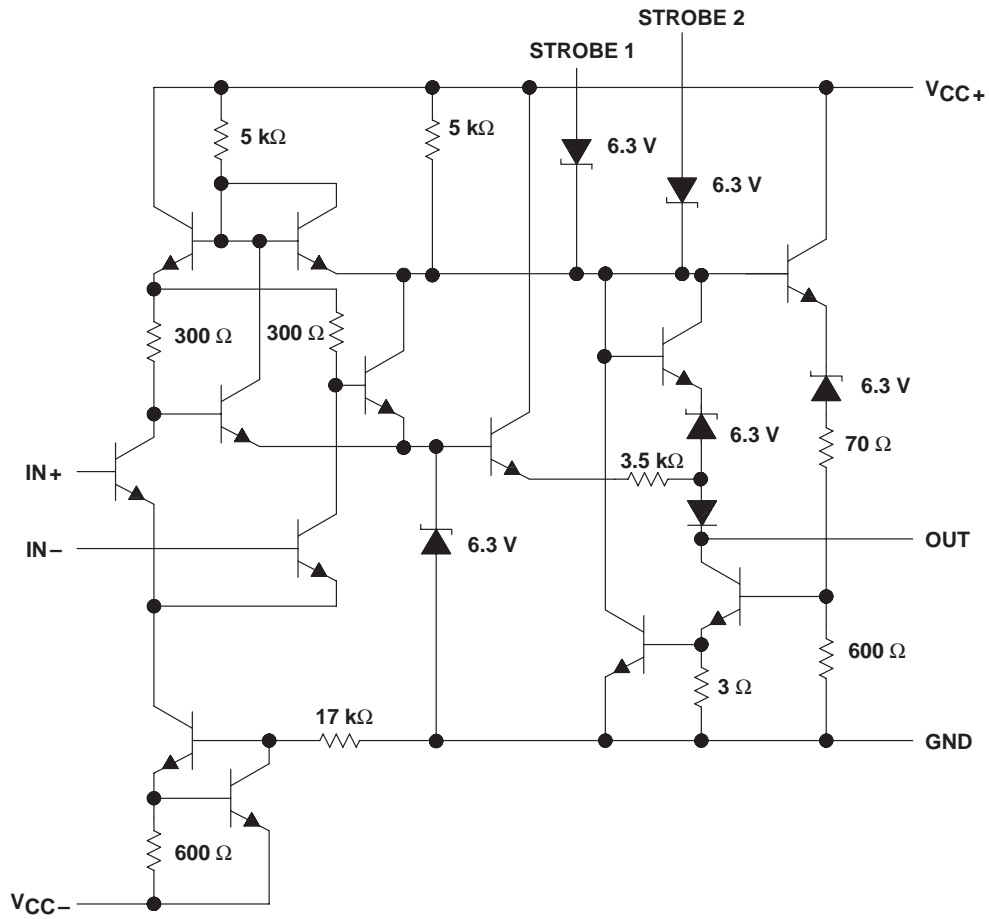

Resistor values are nominal.

LM306 DIFFERENTIAL COMPARATOR WITH STROBES

SLCS008A – OCTOBER 1979 – REVISED OCTOBER 1991

absolute maximum ratings over operating free-air temperature range (unless otherwise noted)†

Supply voltage, V_{CC+} (see Note 1)	15 V
Supply voltage, V_{CC-} (see Note 1)	-15 V
Differential input voltage, V_{ID} (see Note 2)	± 5 V
Input voltage, V_I (either input, see Notes 1 and 3)	± 7 V
Strobe voltage range (see Note 1)	0 V to V_{CC+}
Output voltage, V_O (see Note 1)	24 V
Voltage from output to V_{CC-}	30 V
Duration of output short circuit to ground (see Note 4)	10 s
Continuous total dissipation	See Dissipation Rating Table
Operating free-air temperature range, T_A	0°C to 70°C
Storage temperature range	-65°C to 150°C
Lead temperature 1,6 mm (1/16 inch) from case for 10 seconds	260°C

† Stresses beyond those listed under "absolute maximum ratings" may cause permanent damage to the device. These are stress ratings only, and functional operation of the device at these or any other conditions beyond those indicated under "recommended operating conditions" is not implied. Exposure to absolute-maximum-rated conditions for extended periods may affect device reliability.

- NOTES:
1. All voltage values, except differential voltages and the voltage from the output to V_{CC-} , are with respect to the network ground.
 2. Differential voltages are at $IN+$ with respect to $IN-$.
 3. The magnitude of the input voltage must never exceed the magnitude of the supply voltage or 7 V, whichever is less.
 4. The output may be shorted to ground or either power supply.

DISSIPATION RATING TABLE

PACKAGE	$T_A \leq 25^\circ\text{C}$ POWER RATING	DERATING FACTOR	DERATE ABOVE T_A	$T_A = 70^\circ\text{C}$ POWER RATING
D	600 mW	5.8 mW/°C	46°C	464 mW
P	600 mW	8.0 mW/°C	75°C	600 mW

LM306

DIFFERENTIAL COMPARATOR WITH STROBES

SLCS008A – OCTOBER 1979 – REVISED OCTOBER 1991

electrical characteristics at specified free-air temperature, $V_{CC+} = 12\text{ V}$, $V_{CC-} = -3\text{ V}$ to -12 V (unless otherwise noted)

PARAMETER		TEST CONDITIONS†	T_A ‡	MIN	TYP	MAX	UNIT
V_{IO}	Input offset voltage	$R_S \leq 200\ \Omega$	25°C		1.6§	5	mV
			Full range			6.5	
α_{VIO}	Average temperature coefficient of input offset voltage	$R_S = 50\ \Omega$, See Note 5	Full range		5	20	$\mu\text{V}/^\circ\text{C}$
I_{IO}	Input offset current	See Note 5	25°C		1.8	5	μA
			MIN		1	7.5	
			MAX		0.5	5	
α_{IIO}	Average temperature coefficient of input offset current	See Note 5	MIN to 25°C		24	100	nA/°C
			25°C to MAX		15	50	
I_{IB}	Input bias current	$V_O = 0.5\text{ V}$ to 5 V	MIN to 25°C			40	μA
			25°C to MAX		16	25	
$I_{IL(S)}$	Low-level strobe current	$V(\text{strobe}) = 0.4\text{ V}$	Full range		-1.7	-3.2	mA
$V_{IH(S)}$	High-level strobe voltage		Full range	2.2			V
$V_{IL(S)}$	Low-level strobe voltage		Full range			0.9	V
V_{ICR}	Common-mode input voltage range	$V_{CC-} = -7\text{ V}$ to -12 V	Full range	± 5			V
V_{ID}	Differential input voltage range		Full range	± 5			V
A_{VD}	Large-signal differential voltage amplification	$V_O = 0.5\text{ V}$ to 5 V , No load	25°C		40		V/mV
V_{OH}	High-level output voltage	$I_{OH} = -400\ \mu\text{A}$ $V_{ID} = 8\text{ mV}$	Full range	2.5		5.5	V
V_{OL}	Low-level output voltage	$I_{OL} = 100\text{ mA}$ $V_{ID} = -7\text{ mV}$	25°C		0.8	2	V
		$I_{OL} = 50\text{ mA}$ $V_{ID} = -7\text{ mV}$	Full range			1	
		$I_{OL} = 16\text{ mA}$ $V_{ID} = -8\text{ mV}$	Full range			0.4	
I_{OH}	High-level output voltage	$V_{OH} = 8\text{ V}$ to 24 V	$V_{ID} = 7\text{ mV}$	MIN to 25°C	0.02	2	μA
			$V_{ID} = 8\text{ mV}$	25°C to MAX			
I_{CC+}	Supply current from V_{CC+}	$V_{ID} = -5\text{ mV}$, No load	Full range		6.6	10	mA
I_{CC-}	Supply current from V_{CC-}	No load	Full range		-1.9	-3.6	mA

† Unless otherwise noted, all characteristics are measured with both strobcs open.

‡ Full range is 0°C to 70°C. MIN is 0°C. MAX is 70°C.

§ This typical value is at $V_{CC+} = 12\text{ V}$, $V_{CC-} = -6\text{ V}$.

NOTE 5: The offset voltages and offset currents given are the maximum values required to drive the output down to the low range (V_{OL}) or up to the high range (V_{OH}). These parameters actually define an error band and take into account the worst-case effects of voltage gain and input impedance.

switching characteristics, $V_{CC+} = 12\text{ V}$, $V_{CC-} = -6\text{ V}$, $T_A = 25^\circ\text{C}$

PARAMETER	TEST CONDITIONS†	MIN	TYP	MAX	UNIT
Response time, low-to-high-level output	$R_L = 390\ \Omega$ to 5 V , $C_L = 15\text{ pF}$, See Note 6		28	40	ns

† All characteristics are measured with both strobcs open.

NOTE 6: The response time specified is for a 100-mV input step with 5-mV overdrive and is the interval between the input step function and the instant when the output crosses 1.4 V.



TYPICAL CHARACTERISTICS

Table of Graphs

			FIGURE
I_{IB}	Input bias current	vs Free-air temperature	1
I_{IO}	Input offset current	vs Free-air temperature	2
V_{OH}	High-level output voltage	vs Free-air temperature	3
V_{OL}	Low-level output voltage	vs Free-air temperature	4
V_O	Output voltage	vs Differential input voltage	5
I_O	Output current	vs Differential input voltage	6
A_{VD}	Large-signal differential voltage amplification	vs Free-air temperature	7
I_{OS}	Short-circuit output current	vs Free-air temperature	8
	Output response	vs Time	9, 10
I_{CC+}	Positive supply current	vs Positive supply voltage	11
I_{CC-}	Negative supply current	vs Negative supply voltage	12
P_D	Total power dissipation	vs Free-air temperature	13

**INPUT OFFSET CURRENT
vs
FREE-AIR TEMPERATURE**

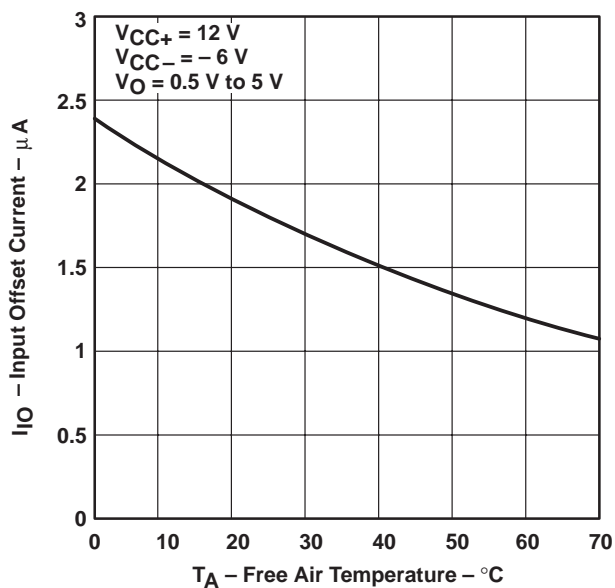

Figure 1

**INPUT BIAS CURRENT
vs
FREE-AIR TEMPERATURE**

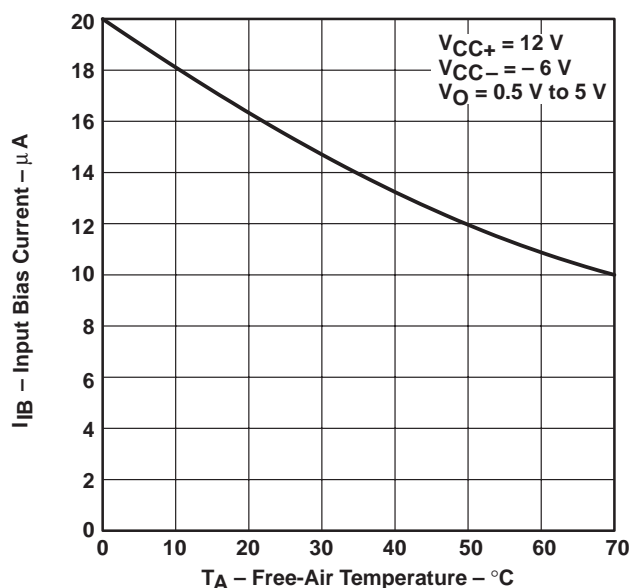

Figure 2

LM306 DIFFERENTIAL COMPARATOR WITH STROBES

SLCS008A – OCTOBER 1979 – REVISED OCTOBER 1991

TYPICAL CHARACTERISTICS

HIGH-LEVEL OUTPUT VOLTAGE
vs
FREE-AIR TEMPERATURE

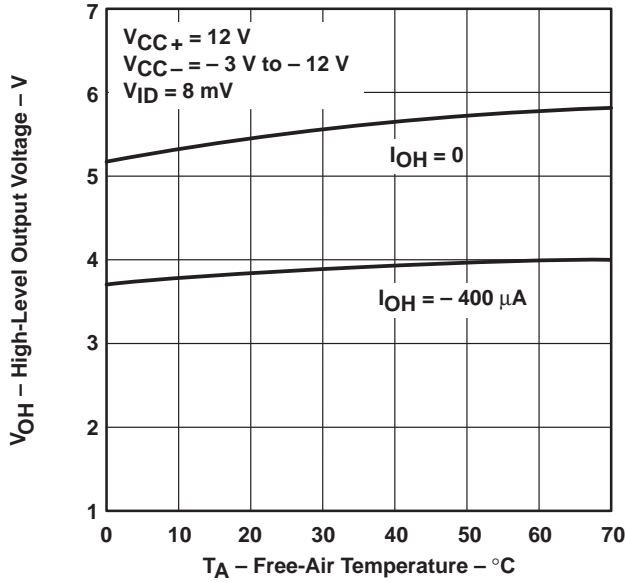

Figure 3

LOW-LEVEL OUTPUT VOLTAGE
vs
FREE-AIR TEMPERATURE

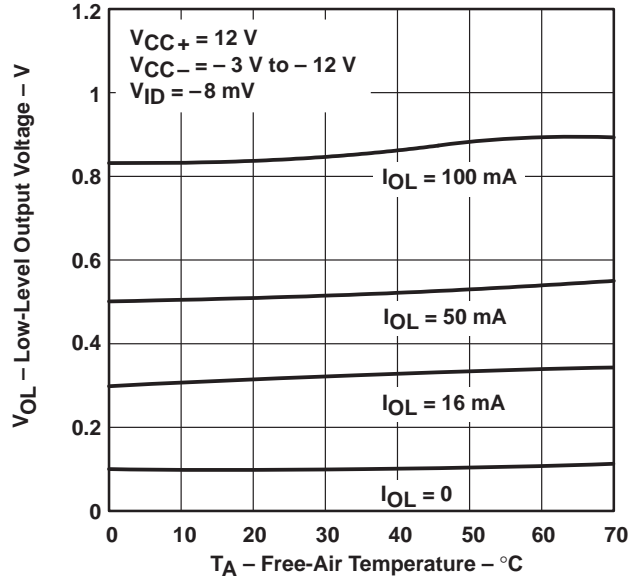

Figure 4

OUTPUT VOLTAGE
vs
DIFFERENTIAL INPUT VOLTAGE

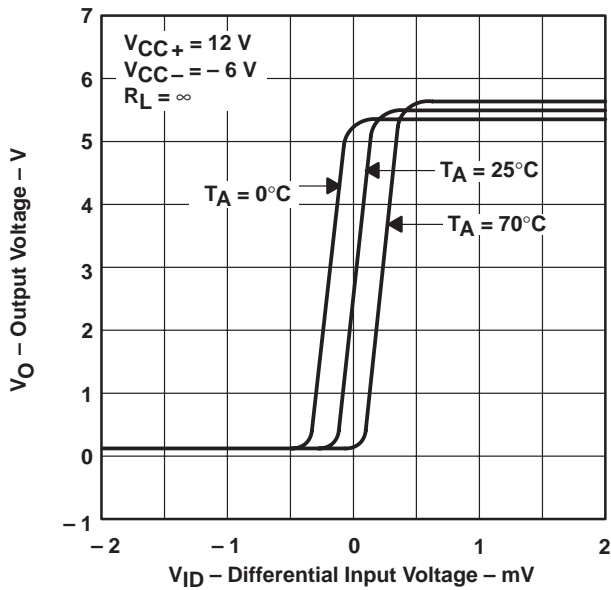

Figure 5

OUTPUT CURRENT
vs
DIFFERENTIAL INPUT VOLTAGE

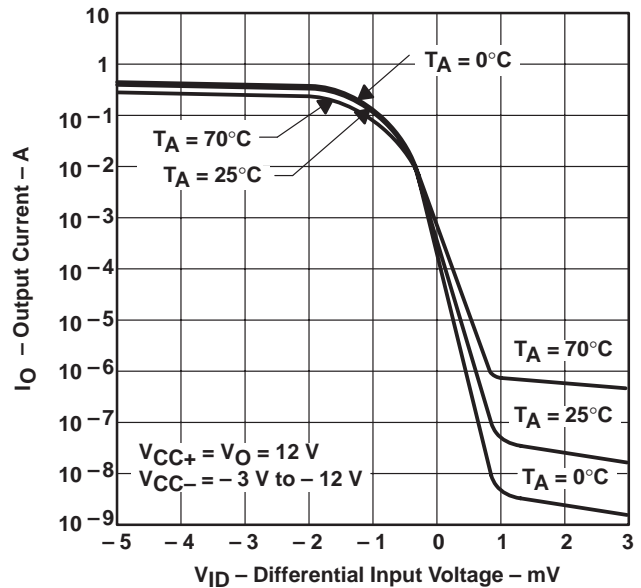
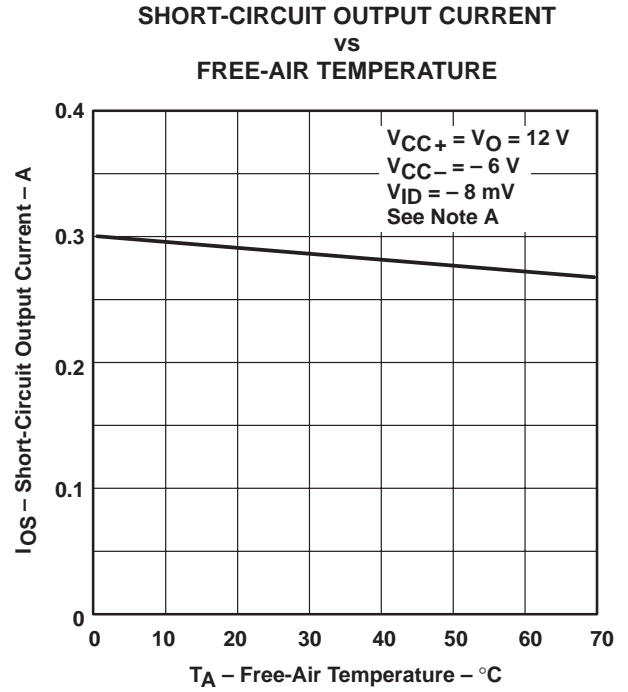
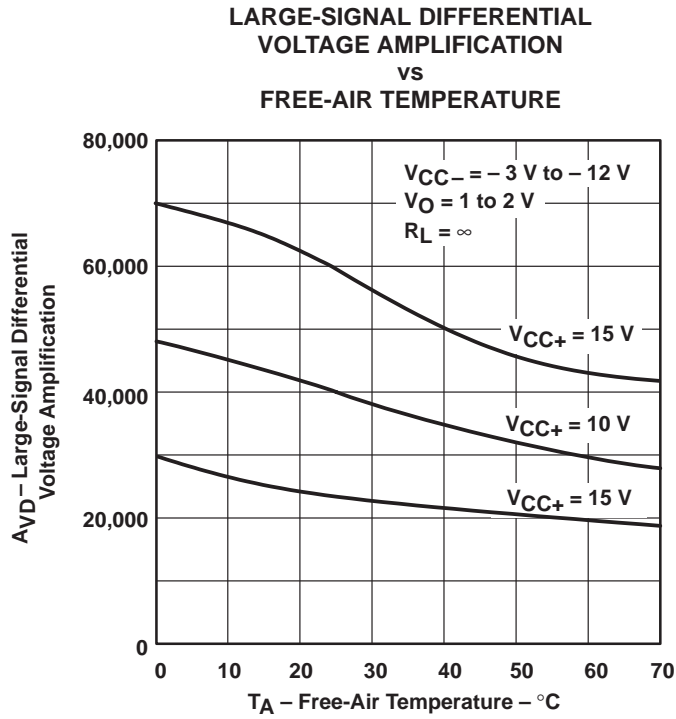
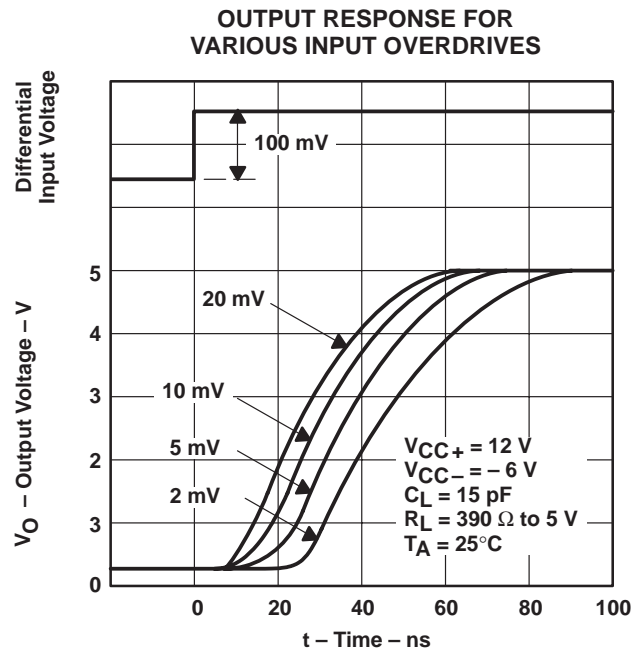
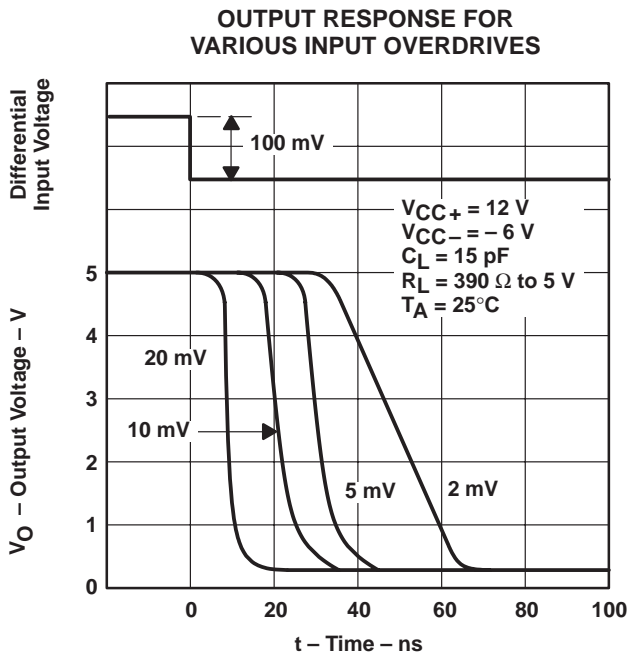

Figure 6

TYPICAL CHARACTERISTICS



NOTE A: This parameter was measured using a single 5-ms pulse.



LM306 DIFFERENTIAL COMPARATOR WITH STROBES

SLCS008A – OCTOBER 1979 – REVISED OCTOBER 1991

TYPICAL CHARACTERISTICS

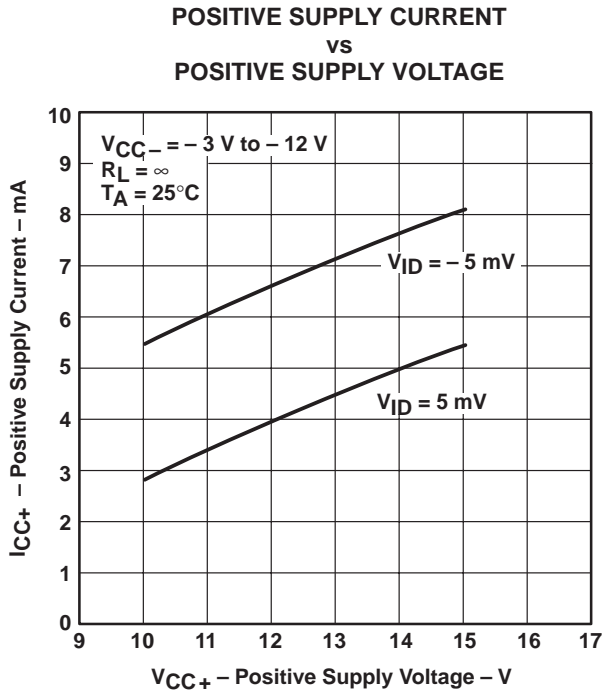

Figure 11

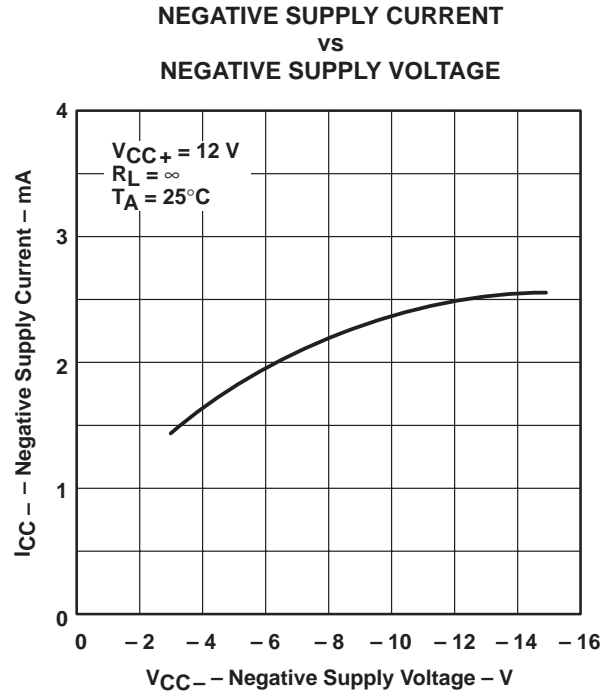

Figure 12

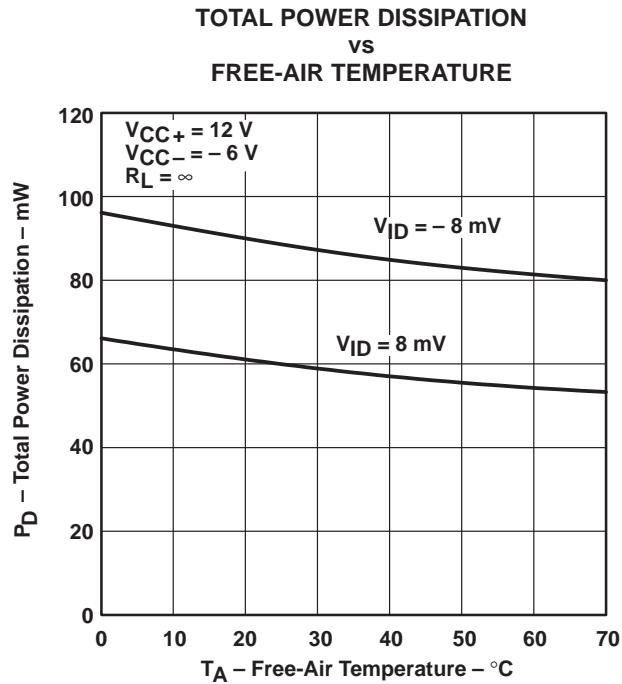

Figure 13

IMPORTANT NOTICE

Texas Instruments and its subsidiaries (TI) reserve the right to make changes to their products or to discontinue any product or service without notice, and advise customers to obtain the latest version of relevant information to verify, before placing orders, that information being relied on is current and complete. All products are sold subject to the terms and conditions of sale supplied at the time of order acknowledgement, including those pertaining to warranty, patent infringement, and limitation of liability.

TI warrants performance of its semiconductor products to the specifications applicable at the time of sale in accordance with TI's standard warranty. Testing and other quality control techniques are utilized to the extent TI deems necessary to support this warranty. Specific testing of all parameters of each device is not necessarily performed, except those mandated by government requirements.

CERTAIN APPLICATIONS USING SEMICONDUCTOR PRODUCTS MAY INVOLVE POTENTIAL RISKS OF DEATH, PERSONAL INJURY, OR SEVERE PROPERTY OR ENVIRONMENTAL DAMAGE ("CRITICAL APPLICATIONS"). TI SEMICONDUCTOR PRODUCTS ARE NOT DESIGNED, AUTHORIZED, OR WARRANTED TO BE SUITABLE FOR USE IN LIFE-SUPPORT DEVICES OR SYSTEMS OR OTHER CRITICAL APPLICATIONS. INCLUSION OF TI PRODUCTS IN SUCH APPLICATIONS IS UNDERSTOOD TO BE FULLY AT THE CUSTOMER'S RISK.

In order to minimize risks associated with the customer's applications, adequate design and operating safeguards must be provided by the customer to minimize inherent or procedural hazards.

TI assumes no liability for applications assistance or customer product design. TI does not warrant or represent that any license, either express or implied, is granted under any patent right, copyright, mask work right, or other intellectual property right of TI covering or relating to any combination, machine, or process in which such semiconductor products or services might be or are used. TI's publication of information regarding any third party's products or services does not constitute TI's approval, warranty or endorsement thereof.