

5 mm (T1 3/4) LED, Diffused

LR 5460, LS 5460, LY 5460
LG 5460

Besondere Merkmale

- eingefärbtes, diffuses Gehäuse
- als optischer Indikator einsetzbar
- Lötspieße ohne Aufsetzebene
- gegurtet lieferbar
- Störimpulsfest nach DIN 40839

Features

- colored, diffused package
- for use as optical indicator
- solder leads without stand-off
- available taped on reel
- load dump resistance acc. to DIN 40839

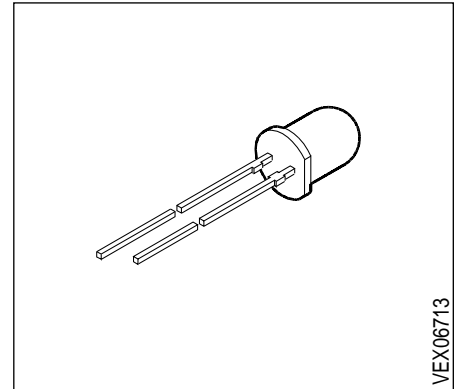

| Typ Type | Emissionsfarbe Color of Emission | Gehäusefarbe Color of Package | Lichtstärke Luminous Intensity $I_F = 10 \text{ mA}$ $I_V \text{ (mcd)}$ | Bestellnummer Ordering Code |
|---|--|-------------------------------------|--|--|
| LR 5460-DG LR 5460-F LR 5460-G LR 5460-FJ | red | red diffused | 0.4 ... 3.2 1.0 ... 2.0 1.6 ... 3.2 1.0 ... 8.0 | Q62703-Q1392 Q62703-Q1393 Q62703-Q1394 Q62703-Q1395 |
| LS 5460-HL LS 5460-J LS 5460-K LS 5460-L LS 5460-JM | super-red | red diffused | 2.5 ... 20.0 4.0 ... 8.0 6.3 ... 12.5 10.0 ... 20.0 4.0 ... 32.0 | Q62703-Q1396 Q62703-Q1746 Q62703-Q1397 Q62703-Q1398 Q62703-Q3225 |
| LY 5460-HL LY 5460-J LY 5460-K LY 5460-L LY 5460-JM | yellow | yellow diffused | 2.5 ... 20.0 4.0 ... 8.0 6.3 ... 12.5 10.0 ... 20.0 4.0 ... 32.0 | Q62703-Q1400 Q62703-Q1401 Q62703-Q1402 Q62703-Q2403 Q62703-Q1403 |
| LG 5460-GK LG 5460-H LG 5460-J LG 5460-K LG 5460-HL | green | green diffused | 1.6 ... 12.5 2.5 ... 5.0 4.0 ... 8.0 6.3 ... 12.5 2.5 ... 20.0 | Q62703-Q1407 Q62703-Q1406 Q62703-Q1867 Q62703-Q2014 Q62703-Q3190 |

Streuung der Lichtstärke in einer Verpackungseinheit $I_{V \max} / I_{V \min} \leq 2.0$.

Luminous intensity ratio in one packaging unit $I_{V \max} / I_{V \min} \leq 2.0$.

Grenzwerte
Maximum Ratings

| Bezeichnung Parameter | Symbol Symbol | Werte Values | | Einheit Unit |
|--|------------------|-----------------|------------|-----------------|
| | | LR | LS, LY, LG | |
| Betriebstemperatur Operating temperature range | T_{op} | - 55 ... + 100 | | °C |
| Lagertemperatur Storage temperature range | T_{stg} | - 55 ... + 100 | | °C |
| Sperrschichttemperatur Junction temperature | T_j | + 100 | | °C |
| Durchlaßstrom Forward current | I_F | 45 | 40 | mA |
| Stoßstrom Surge current $t \leq 10 \mu s, D = 0.005$ | I_{FM} | 0.5 | | A |
| Sperrspannung Reverse voltage | V_R | 5 | | V |
| Verlustleistung Power dissipation $T_A \leq 25 \text{ °C}$ | P_{tot} | 100 | 140 | mW |
| Wärmewiderstand Thermal resistance Sperrschicht / Luft Junction / air | $R_{th JA}$ | 400 | | K/W |

Kennwerte ($T_A = 25\text{ °C}$)

Characteristics

| Bezeichnung Parameter | Symbol Symbol | Werte Values | | | | Einheit Unit |
|---|--|-----------------|------------|------------|------------|--------------------------------|
| | | LR | LS | LY | LG | |
| Wellenlänge des emittierten Lichtes Wavelength at peak emission $I_F = 20\text{ mA}$ | (typ.) λ_{peak} (typ.) | 660 | 635 | 586 | 565 | nm |
| Dominantwellenlänge Dominant wavelength $I_F = 20\text{ mA}$ | (typ.) λ_{dom} (typ.) | 645 | 628 | 590 | 570 | nm |
| Spektrale Bandbreite bei 50 % $I_{\text{rel max}}$ Spectral bandwidth at 50 % $I_{\text{rel max}}$ $I_F = 20\text{ mA}$ | (typ.) $\Delta\lambda$ (typ.) | 35 | 45 | 45 | 25 | nm |
| Abstrahlwinkel bei 50 % I_V (Vollwinkel) Viewing angle at 50 % I_V | 2ϕ | 50 | 50 | 50 | 50 | Grad deg. |
| Durchlaßspannung Forward voltage $I_F = 10\text{ mA}$ | (typ.) V_F (max.) V_F | 1.6 2.0 | 2.0 2.6 | 2.0 2.6 | 2.0 2.6 | V V |
| Sperrstrom Reverse current $V_R = 5\text{ V}$ | (typ.) I_R (max.) I_R | 0.01 10 | 0.01 10 | 0.01 10 | 0.01 10 | μA μA |
| Kapazität Capacitance $V_R = 0\text{ V}, f = 1\text{ MHz}$ | (typ.) C_0 | 25 | 12 | 10 | 15 | pF |
| Schaltzeiten: Switching times: I_V from 10 % to 90 % I_V from 90 % to 10 % $I_F = 100\text{ mA}, t_p = 10\text{ }\mu\text{s}, R_L = 50\text{ }\Omega$ | (typ.) t_r (typ.) t_f | 120 50 | 300 150 | 300 150 | 450 200 | ns ns |

Relative spektrale Emission $I_{rel} = f(\lambda)$, $T_A = 25\text{ °C}$, $I_F = 20\text{ mA}$

Relative spectral emission

$V(\lambda)$ = spektrale Augenempfindlichkeit
Standard eye response curve

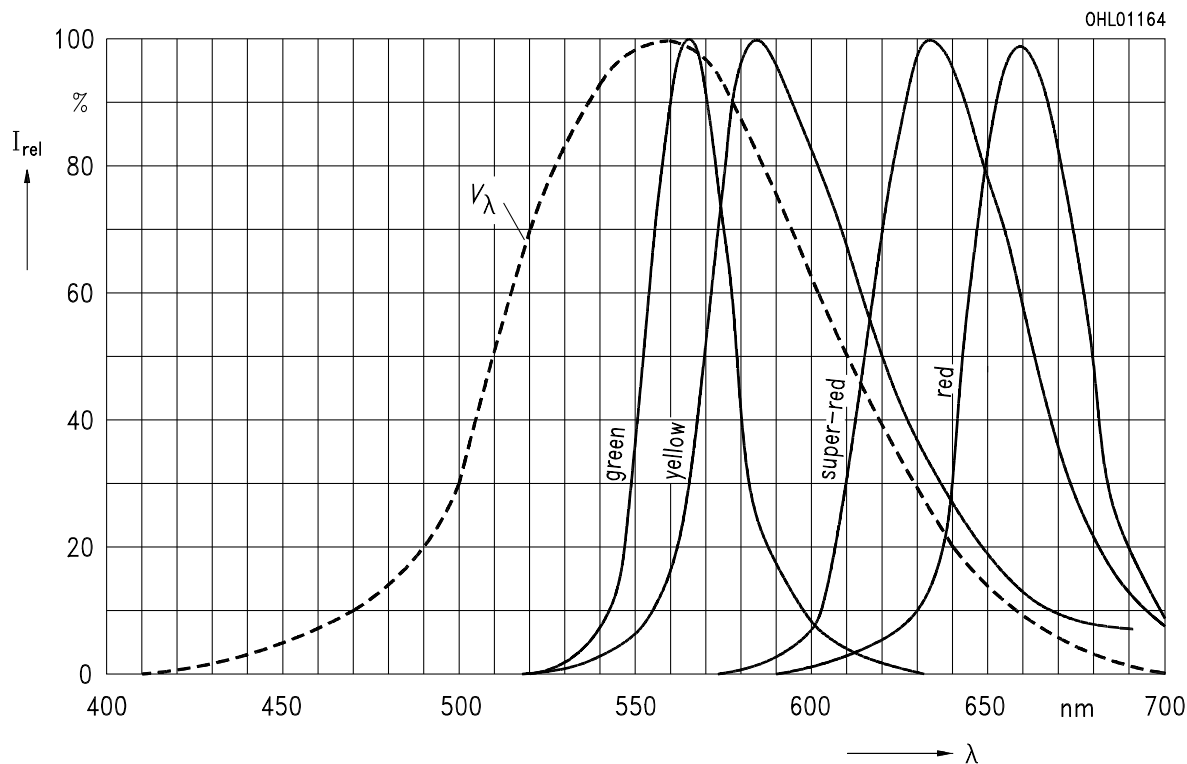

Abstrahlcharakteristik $I_{rel} = f(\varphi)$

Radiation characteristic

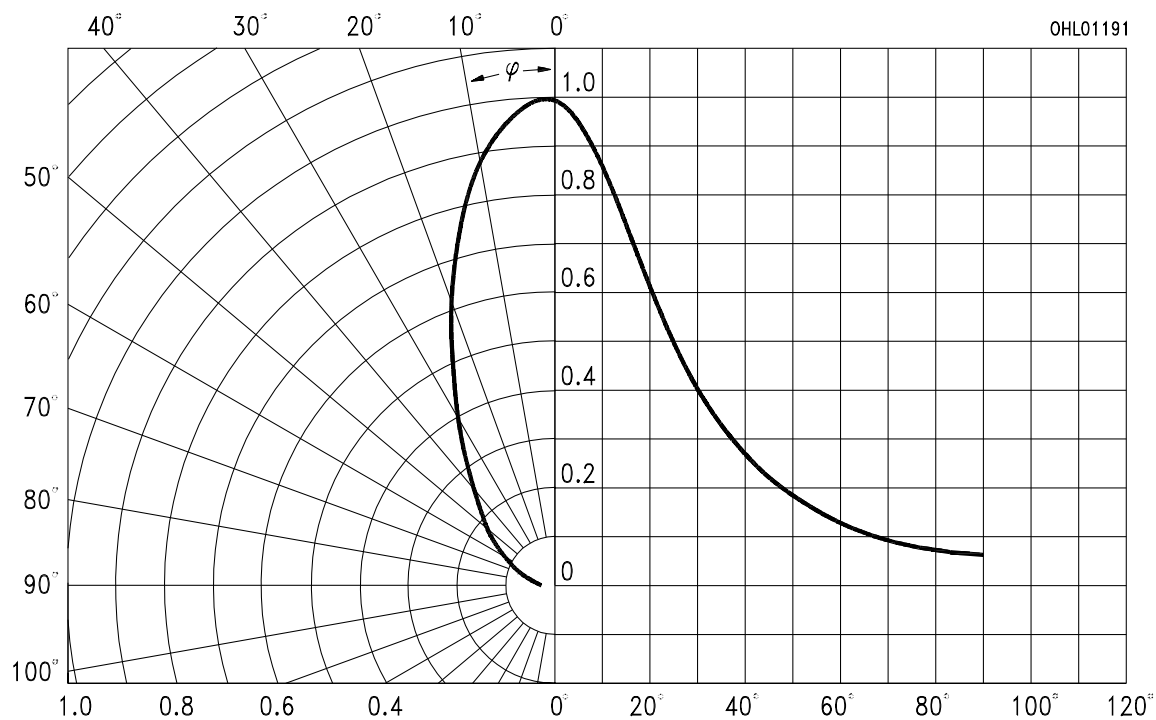

Durchlaßstrom $I_F = f(V_F)$

Forward current

$T_A = 25\text{ °C}$

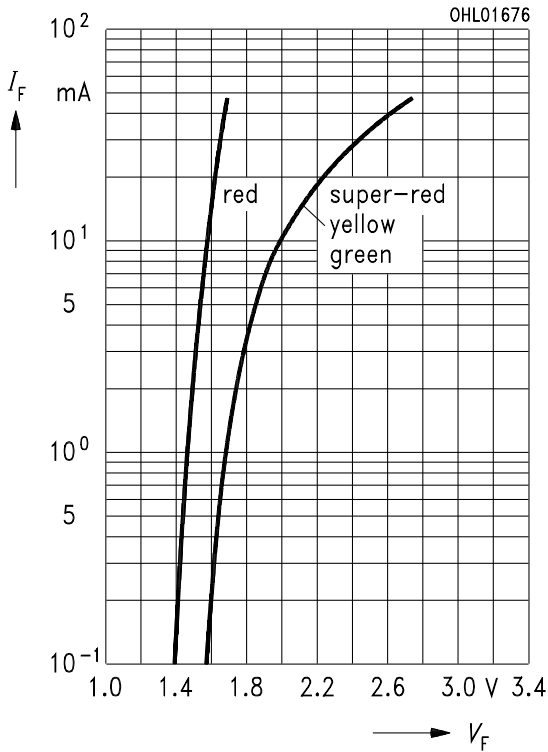

Relative Lichtstärke $I_V/I_{V(10\text{ mA})} = f(I_F)$

Relative luminous intensity

$T_A = 25\text{ °C}$

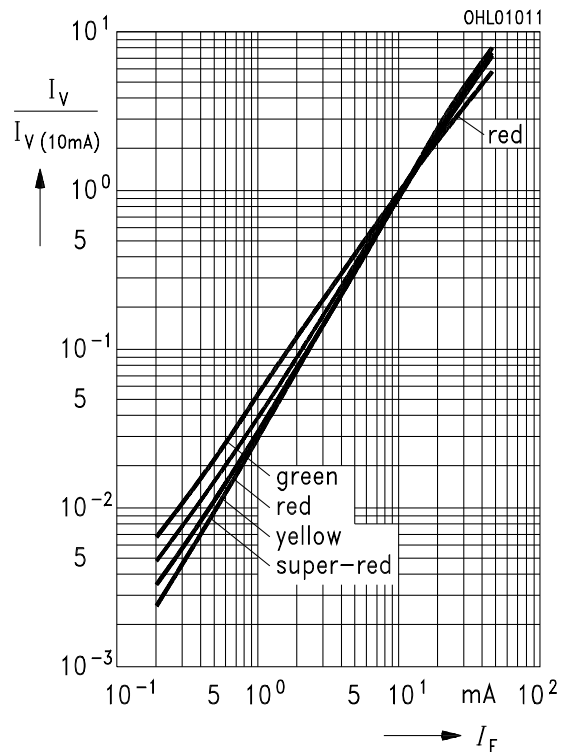

Zulässige Impulsbelastbarkeit $I_F = f(t_p)$

Permissible pulse handling capability

Duty cycle $D = \text{parameter}$, $T_A = 25\text{ °C}$

LS, LY, LG

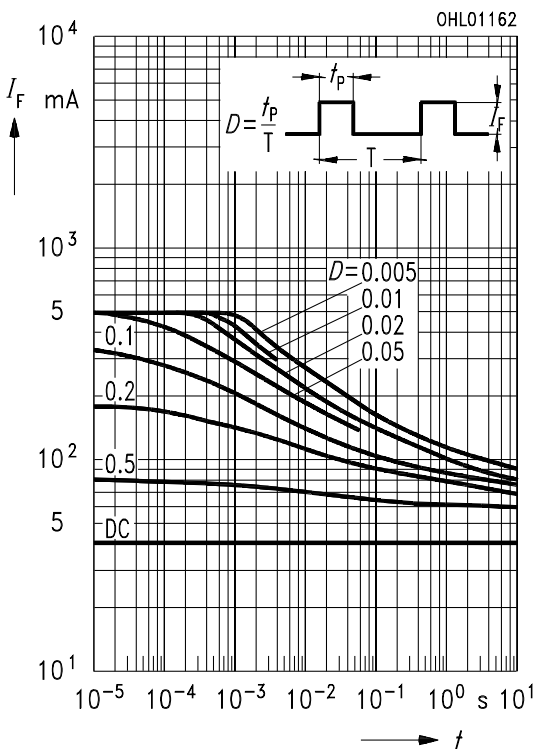

Zulässige Impulsbelastbarkeit $I_F = f(t_p)$

Permissible pulse handling capability

Duty cycle $D = \text{parameter}$, $T_A = 25\text{ °C}$

LR

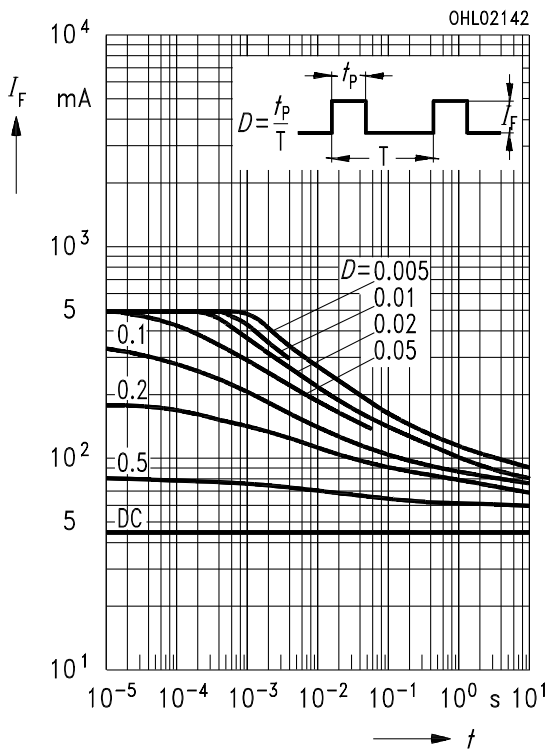

Maximal zulässiger Durchlaßstrom Max. permissible forward current

$$I_F = f(T_A)$$

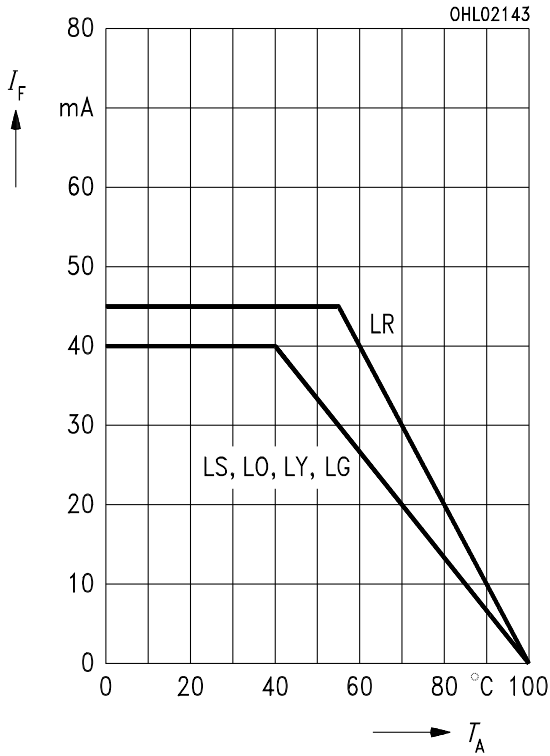

Wellenlänge der Strahlung $\lambda_{\text{peak}} = f(T_A)$ Wavelength at peak emission

$$I_F = 20 \text{ mA}$$

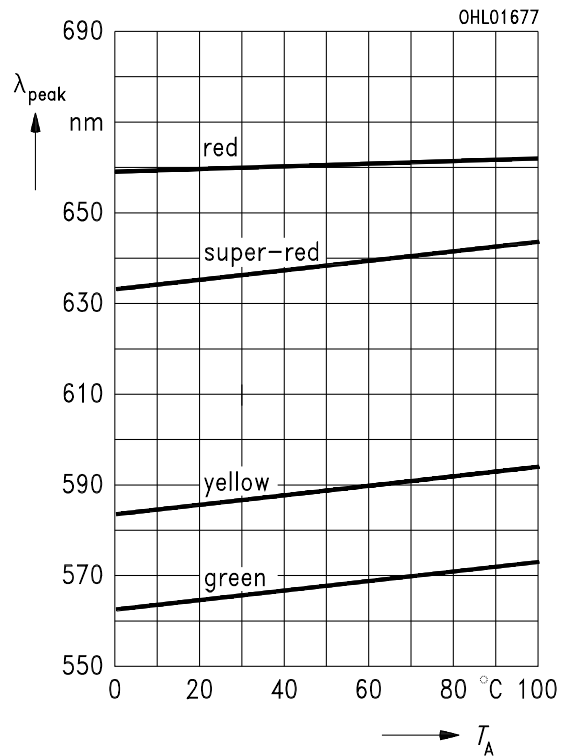

Dominantwavelength $\lambda_{\text{dom}} = f(T_A)$ Dominant wavelength

$$I_F = 20 \text{ mA}$$

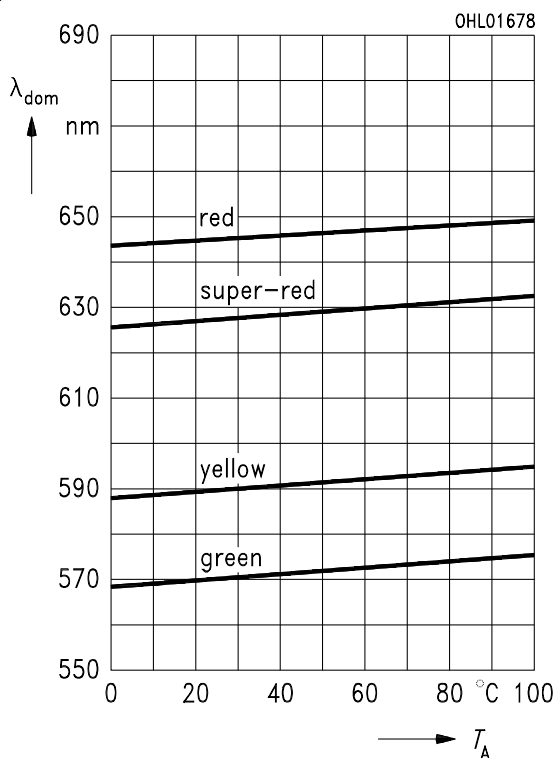

Durchlaßspannung $V_F = f(T_A)$ Forward voltage

$$I_F = 10 \text{ mA}$$

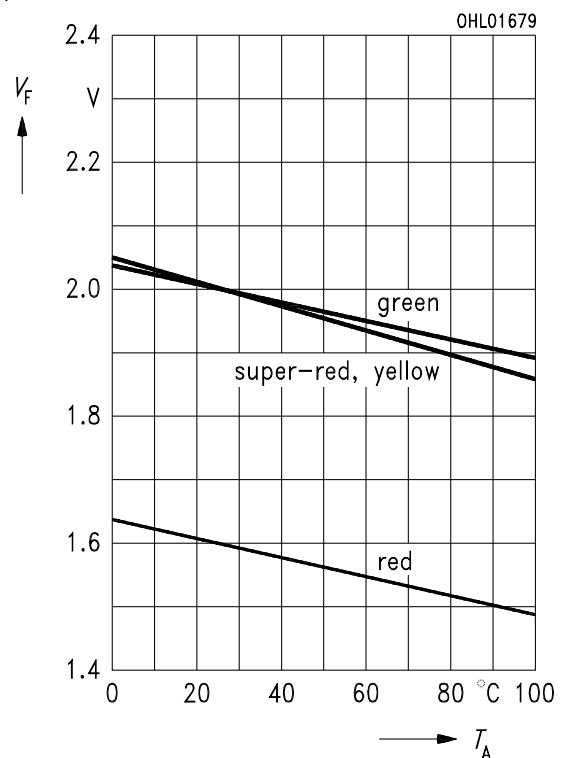

Relative Lichtstärke $I_V/I_{V(25^\circ\text{C})} = f(T_A)$

Relative luminous intensity

$I_F = 10 \text{ mA}$

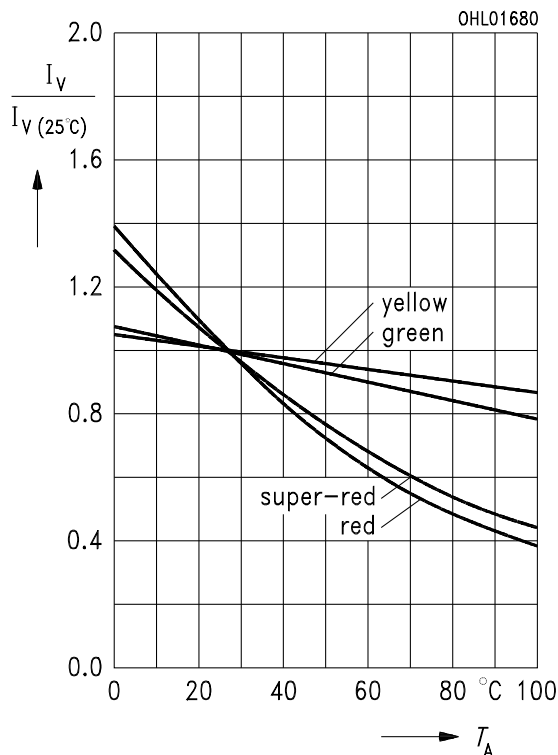

Maßzeichnung (Maße in mm, wenn nicht anders angegeben)
Package Outlines (Dimensions in mm, unless otherwise specified)

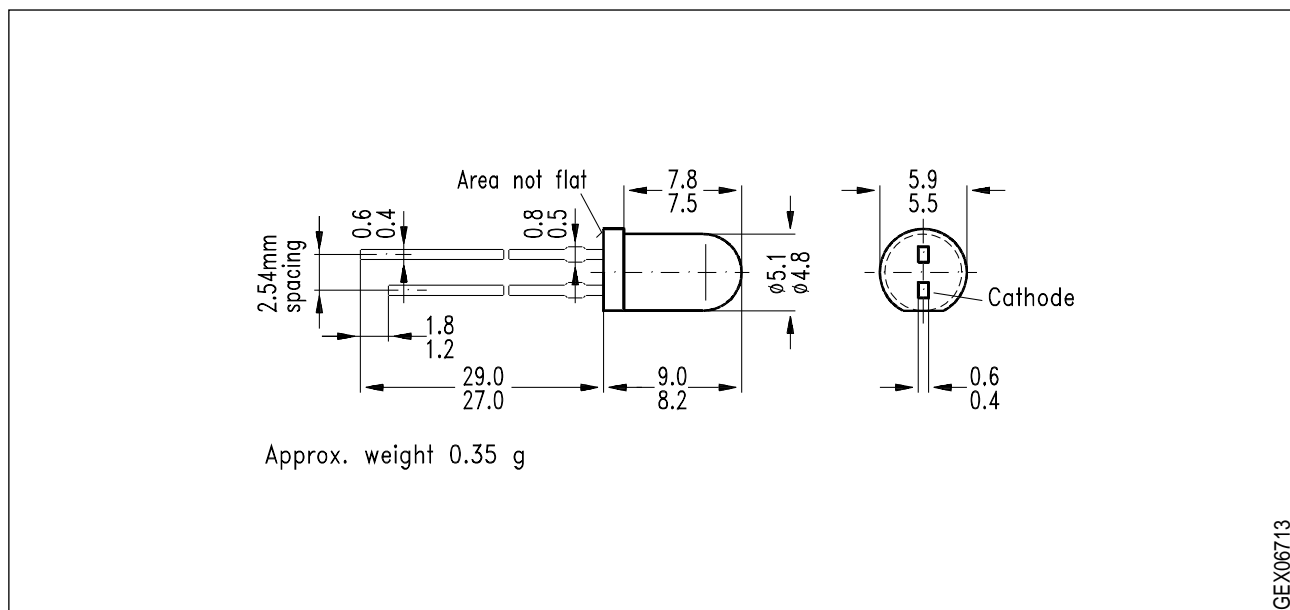

Kathodenkennzeichnung: Kürzerer Lötspieß
Cathode mark: Short solder lead