

MAS9280

IC FOR 18.00 – 40.00 MHz VCTCXO

This is preliminary information on a new product under development. Micro Analog Systems Oy reserves the right to make any changes without notice.

- **Min. Supply Voltage 2.4 V**
- **Max. Frequency 40 MHz**
- **True Sine Wave Output**
- **Frequency Stability +/- 1.5 ppm**
- **Suitable Also for Low Pull Crystals**
- **Very Low Phase Noise**

DESCRIPTION

The MAS9280 is an integrated circuit well suited to build VCTCXO for mobile communication. Temperature calibration is achieved in three calibration temperatures only. The trimming is done through a serial bus and the calibration information is stored in an internal PROM. This means no rework for trimming is needed.

To build a VCTCXO additionally only a crystal is required. The compensation method is fully analog, working continuously without generating any steps or other interference.

Divider function allows the usage of double frequency crystal.

FEATURES

- Very small size
- Minimum V_{DD} 2.4V
- No voltage reference capacitor needed
- Phase noise <-110 dBc/Hz at 100 Hz and <-130 dBc/Hz at 1kHz @ 32 MHz crystal
- Programmable VC-sensitivity
- Oscillator frequency output $f_o / 2$ versions available

APPLICATIONS

- VCTCXO for mobile phones
- VCTCXO for other telecommunications systems

BLOCK DIAGRAM

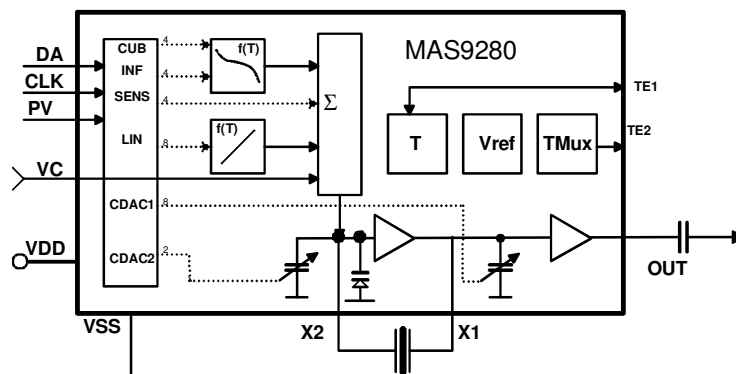

PIN DESCRIPTION

Pin Description	Symbol	MAS9280A1/ A3 /B1/B3 x-coordinate	MAS9280A1/ A3 /B1/B3 y-coordinate	MAS9280A2 /B2 x-coordinate	MAS9280A2 /B2 y-coordinate
Power Supply Voltage	VDD	268	1320	268	1320
Programming Input	PV	604	1320	604	1320
Serial Bus Clock Input	CLK	1047	1320	1420	1320
Serial Bus Data Input	DA	1420	1320	1047	1320
Temperature Output	TE1	1848	1320	1848	1320
Crystal/Varactor Oscillator Input	X2	1048	164	1048	164
Voltage Control Input	VC	268	164	268	164
Crystal Oscillator Output	X1	796	164	796	164
Buffer Output	OUT	2020	164	2020	164
Power Supply Ground	VSS	1701	164	1701	164
Test Multiplexer Output	TE2	2058	1320	2058	1320

Note: Because the substrate of the die is internally connected to GND, the die has to be connected to GND or left floating. Please make sure that GND is the first pad to be bonded. Pick-and-place and all component assembly are recommended to be performed in ESD protected area.

Note: Pad coordinates are measured from the left bottom corner of the chip to the center of the pads. The coordinates may vary depending on sawing width and location, however, distances between pads are accurate.

Note: Test Multiplexer Output is for testing only and must not be connected in module.

ABSOLUTE MAXIMUM RATINGS

Parameter	Symbol	Min	Max	Unit	Note
Supply Voltage	$V_{DD} - V_{SS}$	-0.3	6.0	V	
Input Voltage	V_{IN}	$V_{SS} - 0.3$	$V_{DD} + 0.3$	V	1)
Power Dissipation	P_{MAX}		20	mW	
Storage Temperature	T_{ST}	-55	150	°C	

Note 1: Not valid for programming pin PV

RECOMMENDED OPERATION CONDITIONS

Parameter	Symbol	Conditions	Min	Typ	Max	Unit	Note
Supply Voltage	V_{DD}		2.4	2.6	5.0	V	
Supply Current	I_{CC}	Vdd = 2.8 Volt			1.8	mA	
Operating Temperature	T_{OP}		-40		+85	°C	
Load Capacitance	C_L			8		pF	1
Load Capacitance	C_L			10		pF	2
Crystal Pulling Sensitivity	S		18		30	ppm/pF	
Crystal Rs	C_{RS}				50	Ω	3

Note 1: MAS9280A1, MAS9280A2 and MAS9280A3 with CDAC1 = 160 ...200

Note 2: MAS9280B1, MAS9280B2 and MAS9280B3 with CDAC1 = 160 ...200

Note 3: At 30 MHz to 40 MHz maximum Rs 30 ohm.

ELECTRICAL CHARACTERISTICS

Parameter	Symbol	Min	Typ	Max	Unit	Note
Frequency Range	f_o	18.00		40.00	MHz	1)
Voltage Control Range	V_C	0		VDD	V	
Voltage Control Sensitivity (VCR = 0)	V_{CSENS}		10		ppm/V	
Voltage Control Sensitivity (VCR = 1)	V_{CSENS}		5		ppm/V	2)
Frequency vs. Supply Voltage	df_o			± 0.2	ppm	3)
Frequency vs. Load Change	df_o			± 0.2	ppm	4)
Output Voltage (10k Ω // 10 pF)	V_{out}	0.6	1.0		V _{pp}	
Harmonic Distortion			-25		dBc	
Compensation Range ± 2.5 ppm	T_C	-40		85	$^{\circ}C$	
Compensation Range ± 2.0 ppm	T_C	-30		85	$^{\circ}C$	
Compensation Range ± 1.5 ppm	T_C	-25		75	$^{\circ}C$	
Compensation Range Linear Part	a1	-0.7		0.0	ppm/K	
Compensation Inflection Point	INF	25		31	$^{\circ}C$	
Compensation Range Cubic Part	a3		95		ppm ² /K ³	
Compensation CDAC1 (8 Bit)	C_{X1}	C10		C10 + 10.6	pF	5)
Compensation CDAC2 (2 Bit)	C_{X2}	C20		C20 + 3	pF	6)
Start up Time	T_{START}		2		ms	

Note 1: MAS9280B1, MAS9280B2 and MAS9280B3 maximum frequency are 36MHz

Note 2: default

Note 3: VDD +/- 5%

Note 4: R=10 kohm +/- 10%, C=10 pF +/- 10%

Note 5: typ C10 = 9.7pF

Note 6: typ C20 = 15.2pF

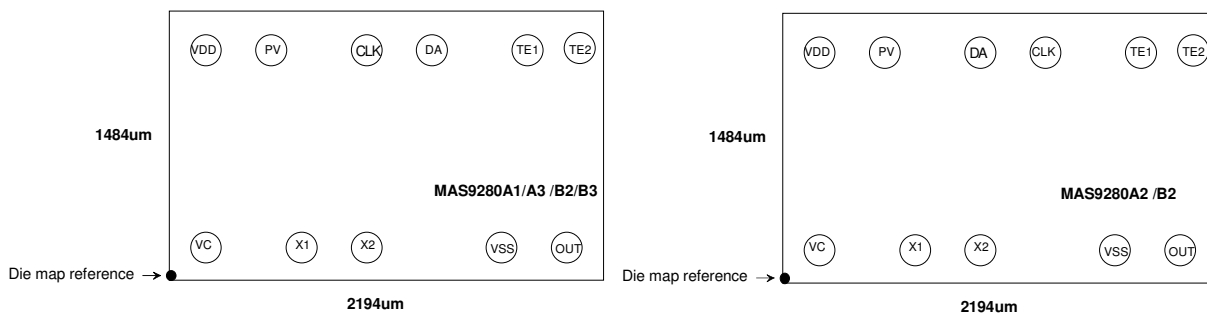
IC OUTLINES

Note 1: MAS9280A and MAS9280B pads are round with 80 μm diameter at opening.

Note 2: Pins CLK and DA can either be connected to VSS or left floating, pin PV can either be connected to VDD or left floating and pin TE1 must be left floating in VCTCXO module end-user application.

Note 3: Die map reference is the actual left bottom corner of the sawn chip.

SAMPLES IN SBDIL 20 PACKAGE

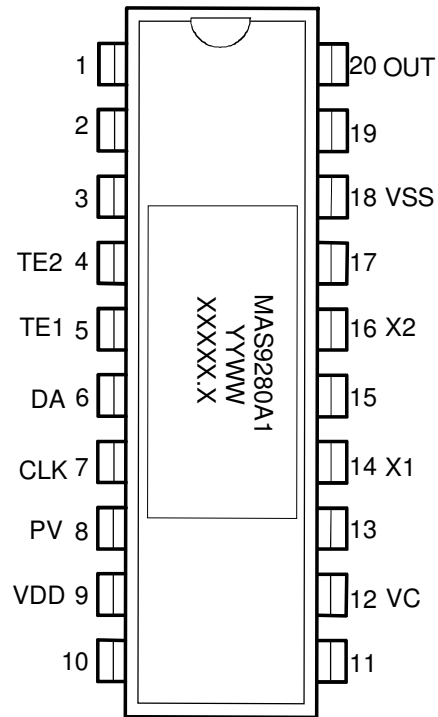

Top marking:
YYWW = Year, Week
XXXXX.X = Lot number

DEVICE OUTLINE CONFIGURATION

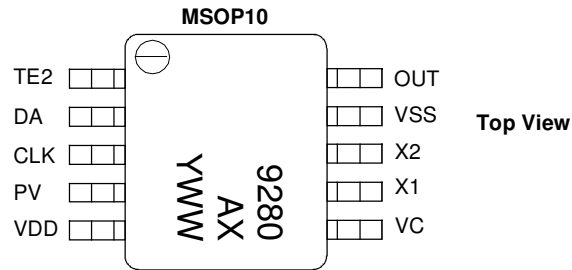

A = product version
X = pad layout and fo version
Y = year
WW= week

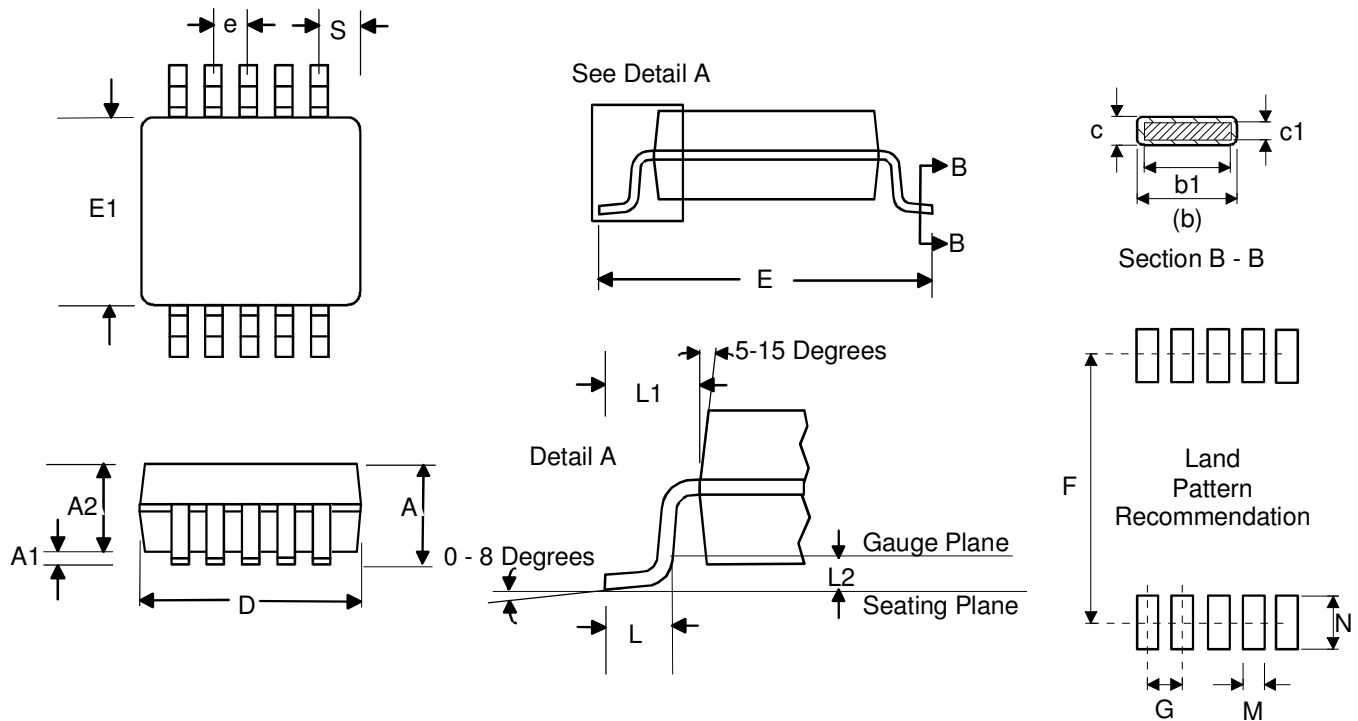
PACKAGE (MSOP-10) OUTLINE

Symbol	Min	Nom	Max	Unit
A	--	--	1.10	mm
A1	0.00	--	0.15	mm
A2	0.75	0.85	0.95	mm
b	0.15	--	0.30	mm
b1	0.15	---	0.25	mm
c	0.08		0.23	mm
c1	0.08		0.18	mm
D		3.00 BSC		mm
E		4.90 BSC		mm
E1		3.00 BSC		mm
e		0.50 BSC		mm
F		4.8		mm
G		0.50		mm
L (Terminal length for soldering)	0.40	0.60	0.80	mm
L1		0.95 REF		
L2		0.25 BSC		mm
M		0.41		mm
N		1.02		mm
S		0.50		Mm

Dimensions do not include mold or interlead flash, protrusions or gate burrs.
 Reference Standard : JEDEC MO-187 BA.

SOLDERING INFORMATION

Resistance to Soldering Heat	According to RSH test IEC 68-2-58/20 2*220°C
Maximum Temperature	240°C
Maximum Number of Reflow Cycles	2
Reflow profile	Thermal profile parameters stated in JESD22-A113 should not be exceeded. http://www.jedec.org
Seating Plane Co-planarity	max 0.08 mm
Lead Finish	Solder plate 7.62 - 25.4 μm, material Sn 85% Pb 15%

EMBOSED TAPE SPECIFICATIONS

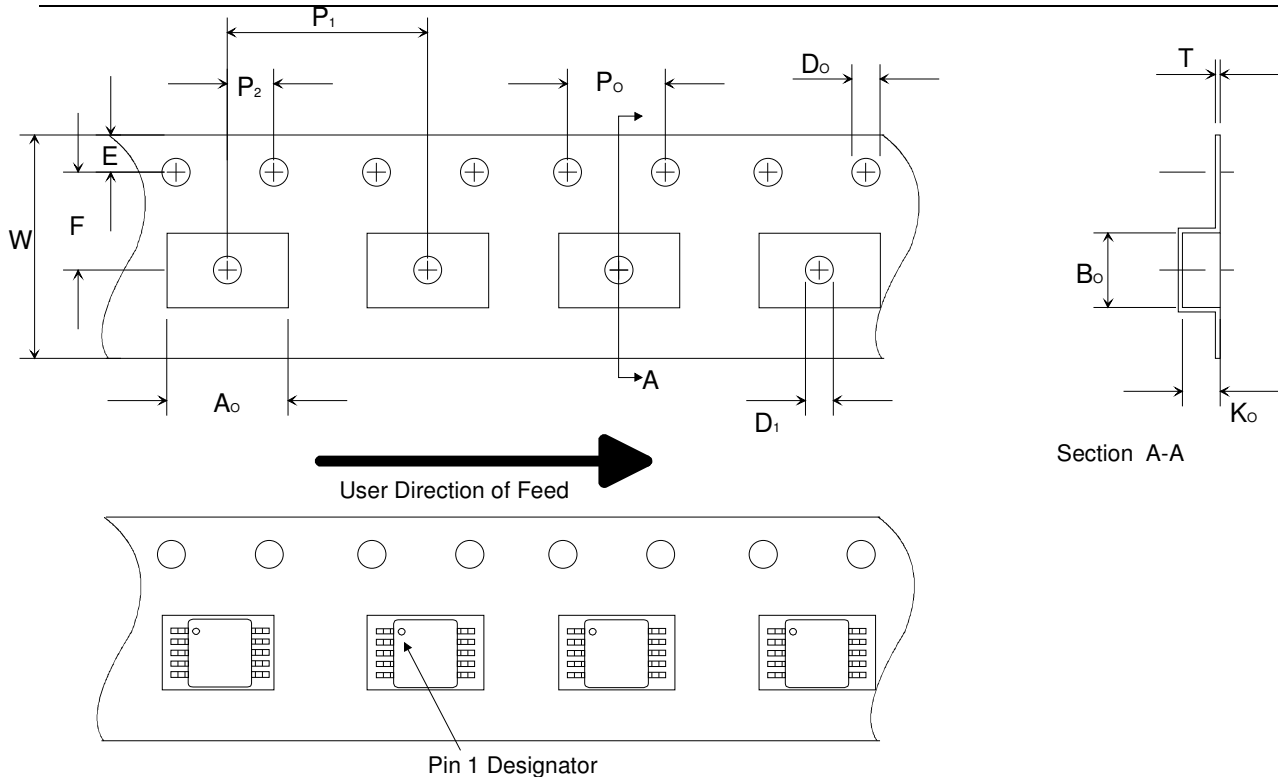

Dimension	Min/Max	Unit
A_o	5.00 ±0.10	mm
B_o	3.20 ±0.10	mm
D_o	1.50 +0.1/-0.0	mm
D_1	1.50 min	mm
E	1.75	mm
F	5.50 ±0.05	mm
K_o	1.45 ±0.10	mm
P_o	4.0	mm
P_1	8.0 ±0.10	mm
P_2	2.0 ±0.05	mm
T	0.3 ±0.05	mm
W	12.00 +0.30/-0.10	mm

REEL SPECIFICATIONS

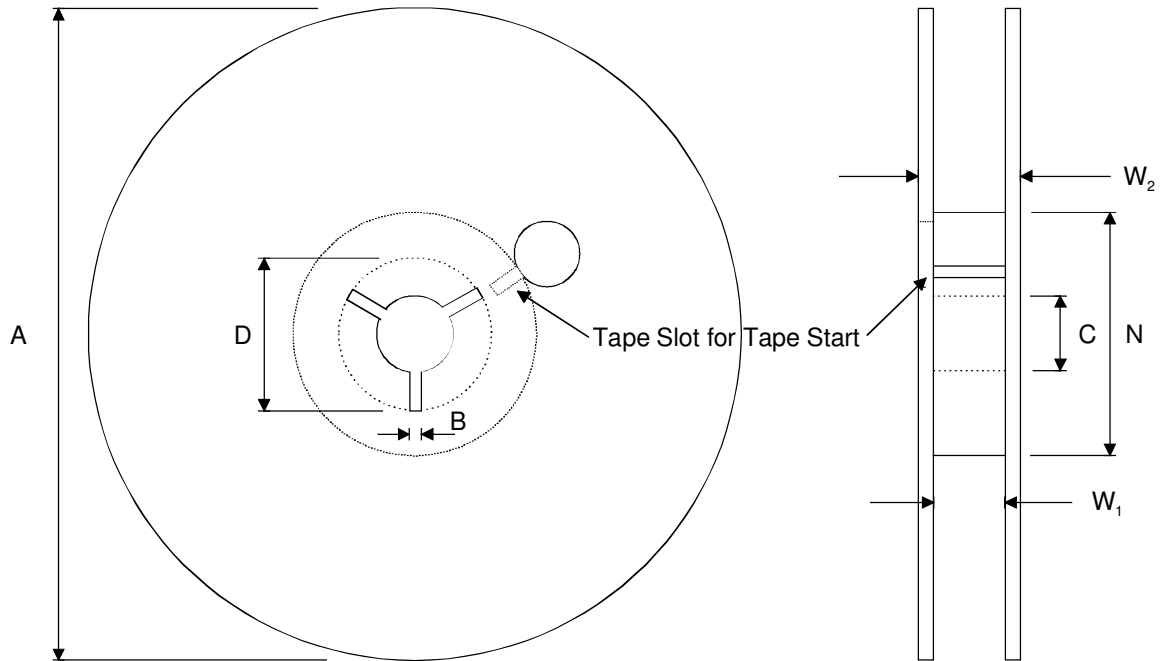

5000 Components on Each Reel
 Reel Material: Conductive, Plastic Antistatic or Static Dissipative
 Carrier Tape Material: Conductive
 Cover Tape Material: Static Dissipative

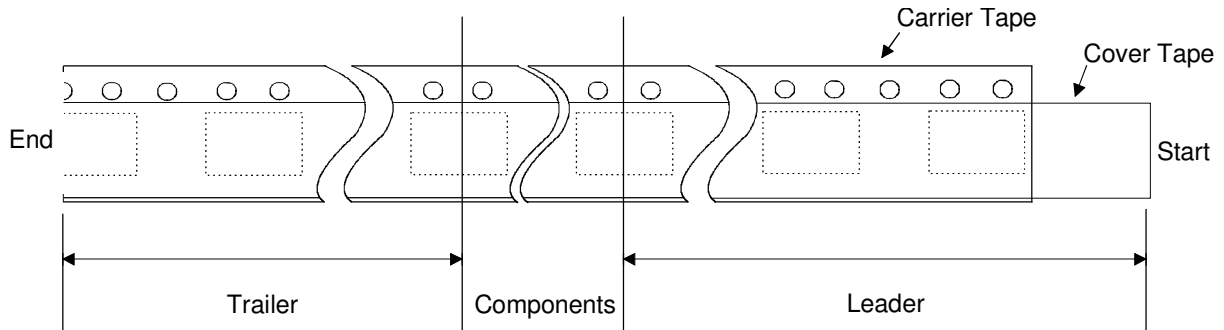

Dimension	Min	Max	Unit
A		330	mm
B	1.5		mm
C	12.80	13.50	mm
D	20.2		mm
N	50		mm
W_1 (measured at hub)	12.4	14.4	mm
W_2 (measured at hub)		18.4	mm
Trailer	160		mm
Leader	390, of which minimum 160 mm of empty carrier tape sealed with cover tape		mm
Weight		1500	g

ORDERING INFORMATION

Product Code	Product	Comments	Package
MAS9280A1TG00	IC FOR VCTCXO	For 8pF Crystal load	EWS Tested wafers 215 μ m
MAS9280A1SM06	IC FOR VCTCXO	For 8pF Crystal load	MSOP-10, T&R/5000 pcs/r.
MAS9280A2TG00	IC FOR VCTCXO, CLK and DA pins swapped round	For 8pF Crystal load	EWS Tested wafers 215 μ m
MAS9280A3TG00	IC FOR VCTCXO, frequency output $f_o / 2$	For 8pF Crystal load	EWS Tested wafers 215 μ m
MAS9280A3SM06	IC FOR VCTCXO, frequency output $f_o / 2$	For 8pF Crystal load	MSOP-10, T&R/5000 pcs/r.
MAS9280B1TG00	IC FOR VCTCXO	For 10pF Crystal load	EWS Tested wafers 215 μ m
MAS9280B1SM06	IC FOR VCTCXO	For 10pF Crystal load	MSOP-10, T&R/5000 pcs/r.
MAS9280B2TG00	IC FOR VCTCXO, CLK and DA pins swapped round	For 10pF Crystal load	EWS Tested wafers 215 μ m
MAS9280B3TG00	IC FOR VCTCXO, frequency output $f_o / 2$	For 10pF Crystal load	EWS Tested wafers 215 μ m
MAS9280B3SM06	IC FOR VCTCXO, frequency output $f_o / 2$	For 10pF Crystal load	MSOP-10, T&R/5000 pcs/r.

Please contact Micro Analog Systems Oy for other wafer thickness options.

LOCAL DISTRIBUTOR

MICRO ANALOG SYSTEMS OY CONTACTS

Micro Analog Systems Oy Kamreerintie 2, P.O. Box 51 FIN-02771 Espoo, FINLAND	Tel. +358 9 80 521 Fax +358 9 805 3213 http://www.mas-oy.com
--	--

NOTICE

Micro Analog Systems Oy reserves the right to make changes to the products contained in this data sheet in order to improve the design or performance and to supply the best possible products. Micro Analog Systems Oy assumes no responsibility for the use of any circuits shown in this data sheet, conveys no license under any patent or other rights unless otherwise specified in this data sheet, and makes no claim that the circuits are free from patent infringement. Applications for any devices shown in this data sheet are for illustration only and Micro Analog Systems Oy makes no claim or warranty that such applications will be suitable for the use specified without further testing or modification.