

MOTOROLA
SEMICONDUCTOR
TECHNICAL DATA

89 DE 6367254 0079964 2

T-33-35

NPN Silicon Power Transistor Module

Energy Management Series

These power transistors are designed for industrial service under practical operating environments found in switching high power inductive loads.

- Energy Efficient Package
- Isolated Mounting Plate (2500 Volts RMS)
- Low Saturation Voltage
- Low Thermal Resistance
- Internal Flyback and Speed-Up Diodes
- High DC Current Gain
- Low Current Terminals Separated from High Current Terminals

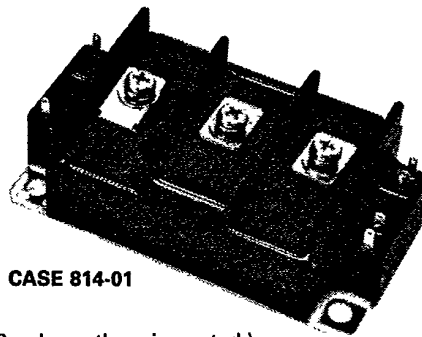

CASE 814-01

MJ100BX100

**DUAL
TRI-STAGE
POWER TRANSISTORS**
100 AMPERES
1000 VOLTS
700 WATTS

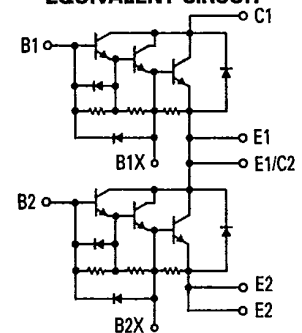
EQUIVALENT CIRCUIT**MAXIMUM RATINGS** (Per Device and $T_C = 25^\circ\text{C}$ unless otherwise noted.)

Rating	Symbol	Value	Unit
Collector-Emitter Sustaining Voltage ($I_B = 0$)	V_{CEO}	880	Vdc
Collector-Emitter Voltage ($V_{BE} = -2\text{ V}$)	$V_{CEX(sus)}$	1000	Vdc
Collector-Base Voltage	V_{CBO}	1000	Vdc
Emitter-Base Voltage	V_{EB}	7	Vdc
Isolation Voltage (ac for 1 minute)	V_{ISOL}	2500	Vac
Collector Current — Continuous — Peak Nonrepetitive for 1 ms	I_C	100 200	A
Base Current — Continuous	I_B	10	A
Total Device Dissipation Derate above $T_C = 25^\circ\text{C}$	P_D	700 5.59	Watts W/°C
Operating Junction and Storage Temperature Range	T_J T_{stg}	-40 to +150 -40 to +125	°C

MECHANICAL RATINGS

Mounting Torque	—	26	in.-lb.
Terminal Torque	—	26	in.-lb.
Per Unit Weight	—	470	grams

THERMAL CHARACTERISTICS

Rating	Symbol	Value	Unit
Maximum Thermal Resistance, Junction to Case	$R_{\theta JC}$	0.179 0.65	°C/W
Transistor C-E Diode			

**MOTOROLA**

ELECTRICAL CHARACTERISTICS (Per Device and $T_C = 25^\circ\text{C}$ unless otherwise noted)

Characteristic	Symbol	Min	Typ	Max	Unit
----------------	--------	-----	-----	-----	------

OFF CHARACTERISTICS

Collector-Emitter Sustaining Voltage (1) ($I_C = 1 \text{ Adc}$, $L = 40 \text{ mH}$)	$V_{CEO(sus)}$	880	—	—	Vdc
Collector Cutoff Current ($V_{CE} = \text{Rated } V_{CB}$, $I_E = 0$)	I_{CBO}	—	—	4	mA
Emitter Cutoff Current ($V_{CB} = 7 \text{ Vdc}$, $I_C = 0$)	I_{EBO}	—	—	400	mA

SAFE OPERATING AREA

Second Breakdown Collector Current with Base Forward-Biased	FBSOA	See Figure 7			
Clamped Inductive SOA with Base Reverse-Biased	RBSOA	See Figure 8			

ON CHARACTERISTICS (1)

DC Current Gain ($I_C = 100 \text{ Adc}$, $V_{CE} = 5 \text{ Vdc}$)	h_{FE}	100	—	—	—
Collector-Emitter Saturation Voltage ($I_C = 100 \text{ Adc}$, $I_B = 2 \text{ Adc}$)	$V_{CE(sat)}$	—	—	2.5	Vdc
Base-Emitter Saturation Voltage ($I_C = 100 \text{ Adc}$, $I_B = 2 \text{ Adc}$)	$V_{BE(sat)}$	—	—	3.5	Vdc

SWITCHING CHARACTERISTICS

Resistive Load						
Turn-On Time	$V_{CC} = 600 \text{ Vdc}$, $I_C = 100 \text{ A}$, $I_{B1} = I_{B2} = 2 \text{ A}$, $t_p = 50 \mu\text{s}$, Duty Cycle $\leq 0.5\%$	t_{on}	—	—	2	μs
Storage Time		t_s	—	—	15	
Fall Time		t_f	—	—	5	

C-E DIODE CHARACTERISTICS

Forward Voltage (1) ($I_F = 100 \text{ Adc}$)	V_F	—	—	1.8	Vdc
Reverse Recovery Time ($I_F = 100 \text{ Adc}$, $V_{EB} = 3 \text{ V}$, $di/dt = 100 \text{ A}/\mu\text{s}$)	t_{rr}	—	—	1	μs

(1) Pulse Test: Pulse width of $300 \mu\text{s}$, duty cycle $\leq 2\%$.

Motorola reserves the right to make changes without further notice to any products herein to improve reliability, function or design. Motorola does not assume any liability arising out of the application or use of any product or circuit described herein; neither does it convey any license under its patent rights nor the rights of others. Motorola and  are registered trademarks of Motorola, Inc. Motorola, Inc. is an Equal Employment Opportunity/Affirmative Action Employer.

TYPICAL ELECTRICAL CHARACTERISTICS

COLLECTOR SATURATION REGION
(PER DEVICE)

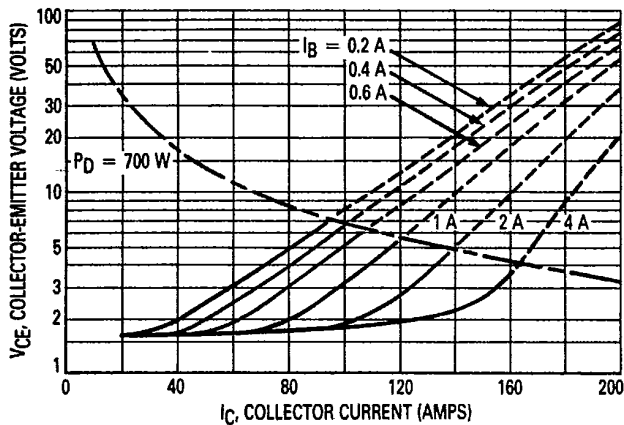

Figure 1. $T_C = +25^\circ\text{C}$

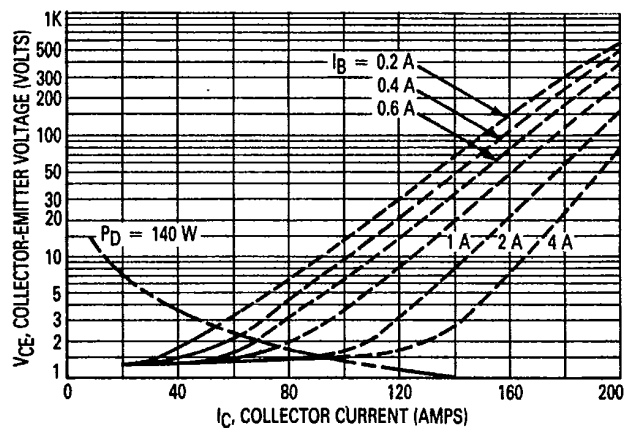

Figure 2. $T_C = +125^\circ\text{C}$

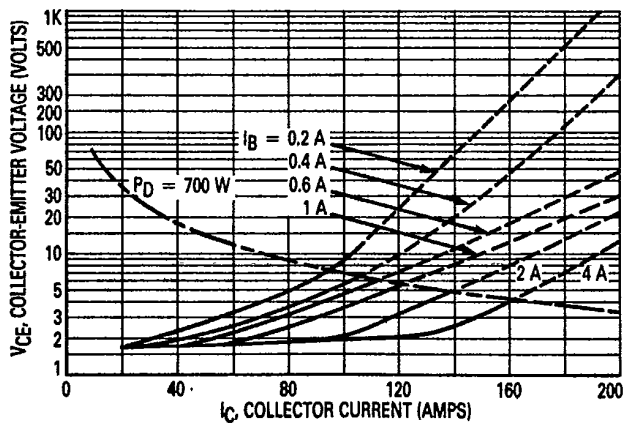

Figure 3. $T_C = -40^\circ\text{C}$

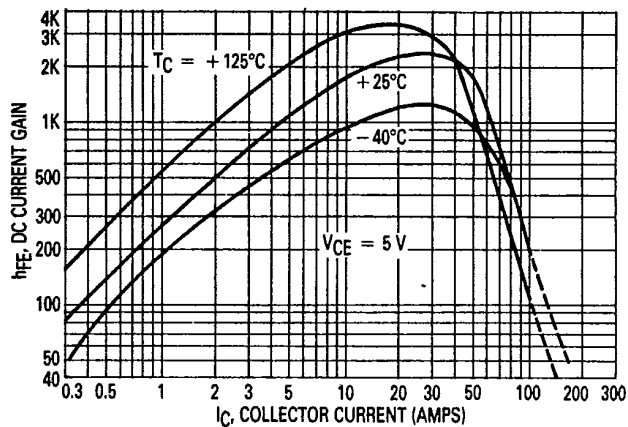

Figure 4. Typical DC Current Gain

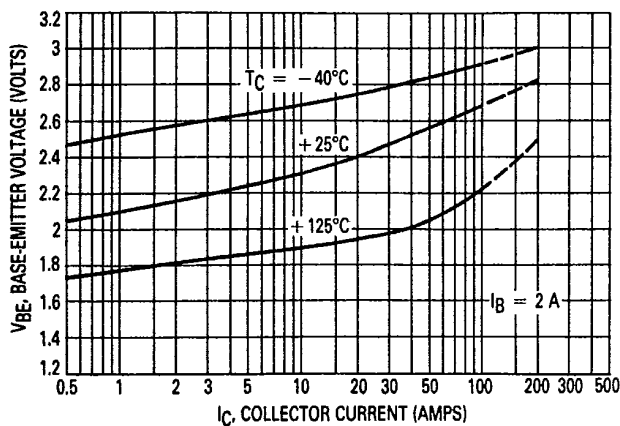

Figure 5. Typical Base-Emitter Saturation Region

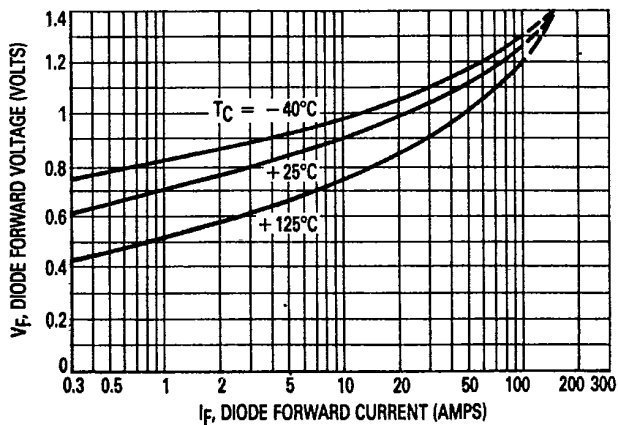
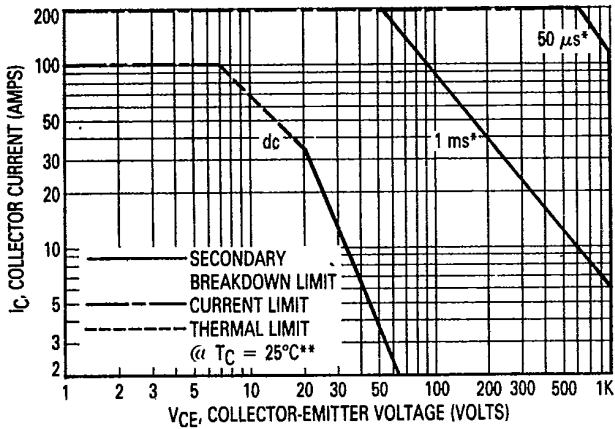

Figure 6. Typical Collector-Emitter Diode Forward Characteristics



*Single nonrepetitive pulse
 **Curves must be derated linearly with increased temperature

Figure 7. Forward Bias Safe Operating Area

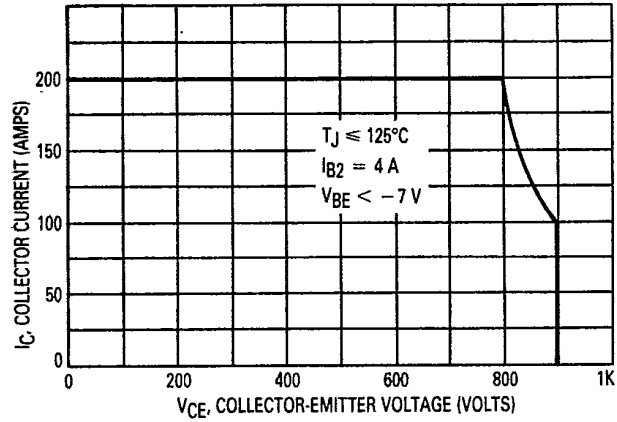

Figure 8. Reverse Bias Safe Operating Area

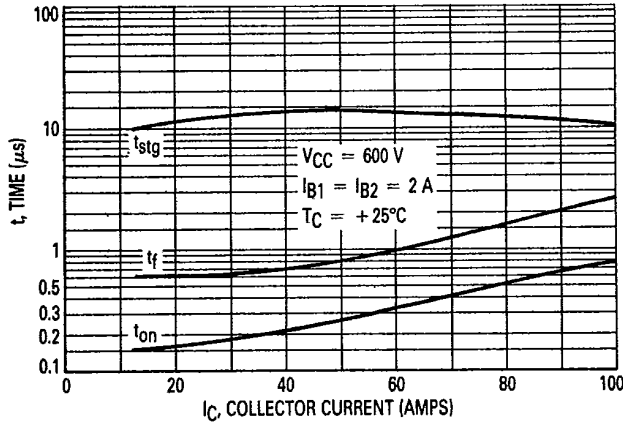

Figure 9. Typical Resistive Switching Times

OUTLINE DIMENSIONS

CASE 814-01

NOTES:

1. POSITIONAL TOLERANCE FOR Q DIMENSION (4 PL): $\pm \phi 0.36 (0.014) \text{ (M) X | A (M) B (M)}$
2. DIMENSIONING AND TOLERANCING PER ANSI Y14.5M, 1982.
3. CONTROLLING DIMENSION: MILLIMETER.
4. TERMINALS 1, 2, 3, 4, 5 AND 6 ARE FAST-ON-TAB # 110.
5. TERMINALS 7, 8, AND 9 USE M5 SCREWS.

STYLE 1:

1. BASE 2X
2. BASE 2
3. EMITTER 2
4. EMITTER 1
5. BASE 1
6. BASE 1X
7. COLLECTOR 2/EMITTER 1
8. EMITTER 2
9. COLLECTOR 1

DIM	MILLIMETERS		INCHES	
	MIN	MAX	MIN	MAX
A	107.2	108.8	4.221	4.283
B	61.2	62.8	2.410	2.472
C	22.0	25.0	0.867	0.984
D	2.5	3.5	0.099	0.137
E	24.5	25.5	0.965	1.003
F	21.0	22.0	0.827	0.866
G	93.0 BSC		3.661 BSC	
H	34.2	35.8	1.347	1.409
J	28.5	29.5	1.122	1.161
K	7.4	8.6	0.292	0.338
L	—	38.0	—	1.496
N	53.2	54.8	2.095	2.157
P	48.0 BSC		1.890 BSC	
Q	6.2	6.8	0.244	0.267
R	79.2	80.8	3.119	3.181
T	105.2	106.8	4.142	4.204
V	59.2	60.8	2.331	2.393
W	3.5	4.5	0.138	0.177
Y	27.5	28.5	1.083	1.122
Z	16.5	17.5	0.650	0.688
e	48.5	49.5	1.910	1.948
f	5.5	6.5	0.217	0.255

Literature Distribution Centers:

USA: Motorola Literature Distribution; P.O. Box 20912; Phoenix, Arizona 85036.
 EUROPE: Motorola Ltd.; European Literature Center; 88 Tanners Drive, Blakelands Milton Keynes, MK145BP, England.
 ASIA PACIFIC: Motorola Semiconductors H.K. Ltd.; P.O. Box 80300; Cheung Sha Wan Post Office; Kowloon Hong Kong.



MOTOROLA