



RF Power Field Effect Transistors

N-Channel Enhancement-Mode Lateral MOSFETs

Designed for CDMA base station applications with frequencies from 1805 to 1880 MHz. Suitable for CDMA and multicarrier amplifier applications. To be used in Class AB and Class C for PCN - PCS/cellular radio and WLL applications.

- Typical Single-Carrier W-CDMA Performance: $V_{DD} = 28$ Volts, $I_{DQ} = 1400$ mA, $P_{out} = 50$ Watts Avg., Full Frequency Band, 3GPP Test Model 1, 64 DPCH with 50% Clipping, Channel Bandwidth = 3.84 MHz, Input Signal PAR = 7.5 dB @ 0.01% Probability on CCDF.
 Power Gain — 17.5 dB
 Drain Efficiency — 31%
 Device Output Signal PAR — 6.2 dB @ 0.01% Probability on CCDF
 ACPR @ 5 MHz Offset — -37 dBc in 3.84 MHz Channel Bandwidth
- Capable of Handling 5:1 VSWR, @ 32 Vdc, 1840 MHz, 170 Watts CW Peak Tuned Output Power
- P_{out} @ 1 dB Compression Point ≥ 170 Watts CW

Features

- 100% PAR Tested for Guaranteed Output Power Capability
- Characterized with Series Equivalent Large-Signal Impedance Parameters
- Internally Matched for Ease of Use
- Integrated ESD Protection
- Greater Negative Gate-Source Voltage Range for Improved Class C Operation
- Designed for Digital Predistortion Error Correction Systems
- RoHS Compliant
- In Tape and Reel. R3 Suffix = 250 Units per 56 mm, 13 inch Reel.

MRF7S18170HR3
MRF7S18170HSR3

1805-1880 MHz, 50 W AVG., 28 V
SINGLE W-CDMA
LATERAL N-CHANNEL
RF POWER MOSFETs

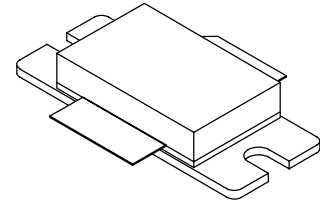

CASE 465B-03, STYLE 1
NI-880
MRF7S18170HR3

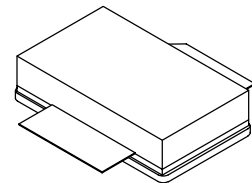

CASE 465C-02, STYLE 1
NI-880S
MRF7S18170HSR3

Table 1. Maximum Ratings

Rating	Symbol	Value	Unit
Drain-Source Voltage	V_{DSS}	-0.5, +65	Vdc
Gate-Source Voltage	V_{GS}	-6.0, +10	Vdc
Operating Voltage	V_{DD}	32, +0	Vdc
Storage Temperature Range	T_{stg}	-65 to +150	°C
Case Operating Temperature	T_C	150	°C
Operating Junction Temperature (1,2)	T_J	225	°C

Table 2. Thermal Characteristics

Characteristic	Symbol	Value (2,3)	Unit
Thermal Resistance, Junction to Case Case Temperature 84°C, 170 W CW Case Temperature 79°C, 50 W CW	$R_{\theta JC}$	0.27 0.30	°C/W

1. Continuous use at maximum temperature will affect MTTF.
2. MTTF calculator available at <http://www.freescale.com/rf>. Select Tools/Software/Application Software/Calculators to access the MTTF calculators by product.
3. Refer to AN1955, *Thermal Measurement Methodology of RF Power Amplifiers*. Go to <http://www.freescale.com/rf>. Select Documentation/Application Notes - AN1955.

Table 3. ESD Protection Characteristics

Test Methodology	Class
Human Body Model (per JESD22-A114)	IA (Minimum)
Machine Model (per EIA/JESD22-A115)	B (Minimum)
Charge Device Model (per JESD22-C101)	IV (Minimum)

Table 4. Electrical Characteristics ($T_C = 25^\circ\text{C}$ unless otherwise noted)

Characteristic	Symbol	Min	Typ	Max	Unit
Off Characteristics					
Zero Gate Voltage Drain Leakage Current ($V_{DS} = 65\text{ Vdc}$, $V_{GS} = 0\text{ Vdc}$)	I_{DSS}	—	—	10	μAdc
Zero Gate Voltage Drain Leakage Current ($V_{DS} = 28\text{ Vdc}$, $V_{GS} = 0\text{ Vdc}$)	I_{DSS}	—	—	1	μAdc
Gate-Source Leakage Current ($V_{GS} = 5\text{ Vdc}$, $V_{DS} = 0\text{ Vdc}$)	I_{GSS}	—	—	1	μAdc

On Characteristics

Gate Threshold Voltage ($V_{DS} = 10\text{ Vdc}$, $I_D = 372\ \mu\text{Adc}$)	$V_{GS(th)}$	1.2	2	2.7	Vdc
Gate Quiescent Voltage ($V_{DS} = 28\text{ Vdc}$, $I_D = 1400\text{ mAdc}$)	$V_{GS(Q)}$	—	2.7	—	Vdc
Fixture Gate Quiescent Voltage (1) ($V_{DS} = 28\text{ Vdc}$, $I_D = 1400\text{ mAdc}$, Measured in Functional Test)	$V_{GG(Q)}$	4	5.4	7.6	Vdc
Drain-Source On-Voltage ($V_{GS} = 10\text{ Vdc}$, $I_D = 3.72\text{ Adc}$)	$V_{DS(on)}$	0.1	0.15	0.3	Vdc

Dynamic Characteristics (2)

Reverse Transfer Capacitance ($V_{DS} = 28\text{ Vdc} \pm 30\text{ mV(rms)ac}$ @ 1 MHz, $V_{GS} = 0\text{ Vdc}$)	C_{rss}	—	0.87	—	pF
Output Capacitance ($V_{DS} = 28\text{ Vdc} \pm 30\text{ mV(rms)ac}$ @ 1 MHz, $V_{GS} = 0\text{ Vdc}$)	C_{oss}	—	703	—	pF

Functional Tests (In Freescale Test Fixture, 50 ohm system) $V_{DD} = 28\text{ Vdc}$, $I_{DQ} = 1400\text{ mA}$, $P_{out} = 50\text{ W Avg.}$, $f = 1807.5\text{ MHz}$ and $f = 1877.5\text{ MHz}$, Single-Carrier W-CDMA, 3GPP Test Model 1, 64 DPCH, 50% Clipping, PAR = 7.5 dB @ 0.01% Probability on CCDF. ACPR measured in 3.84 MHz Channel Bandwidth @ $\pm 5\text{ MHz}$ Offset.

Power Gain	G_{ps}	16	17.5	19	dB
Drain Efficiency	η_D	29	31	—	%
Output Peak-to-Average Ratio @ 0.01% Probability on CCDF MRF7S18170HR3 MRF7S18170HSR3	PAR	5.8 5.7	6.2 6.2	— —	dB
Adjacent Channel Power Ratio	ACPR	—	-37	-35	dBc
Input Return Loss	IRL	—	-15	-9	dB

- $V_{GG} = 2 \times V_{GS(Q)}$. Parameter measured on Freescale Test Fixture, due to resistive divider network on the board. Refer to Test Circuit schematic.
- Part internally matched both on input and output.

(continued)

Table 4. Electrical Characteristics ($T_C = 25^\circ\text{C}$ unless otherwise noted) (continued)

Characteristic	Symbol	Min	Typ	Max	Unit
Typical Performances (In Freescale Test Fixture, 50 ohm system) $V_{DD} = 28\text{ Vdc}$, $I_{DQ} = 1400\text{ mA}$, 1805-1880 MHz Bandwidth					
Video Bandwidth (Tone Spacing from 100 kHz to VBW) $\Delta\text{IMD3} = \text{IMD3 @ VBW frequency} - \text{IMD3 @ 100 kHz} < 1\text{ dBc}$ (both sidebands)	VBW	—	25	—	MHz
Gain Flatness in 75 MHz Bandwidth @ $P_{\text{out}} = 170\text{ W CW}$	G_F	—	0.4	—	dB
Deviation from Linear Phase in 75 MHz Bandwidth @ $P_{\text{out}} = 170\text{ W CW}$	Φ	—	2.5	—	°
Group Delay @ $P_{\text{out}} = 170\text{ W CW}$, $f = 1840\text{ MHz}$	Delay	—	4.2	—	ns
Part-to-Part Insertion Phase Variation @ $P_{\text{out}} = 170\text{ W CW}$, $f = 1840\text{ MHz}$	$\Delta\Phi$	—	15	—	°
Gain Variation over Temperature	ΔG	—	0.015	—	dB/°C
Output Power Variation over Temperature	$\Delta P_{1\text{dB}}$	—	0.01	—	dBm/°C

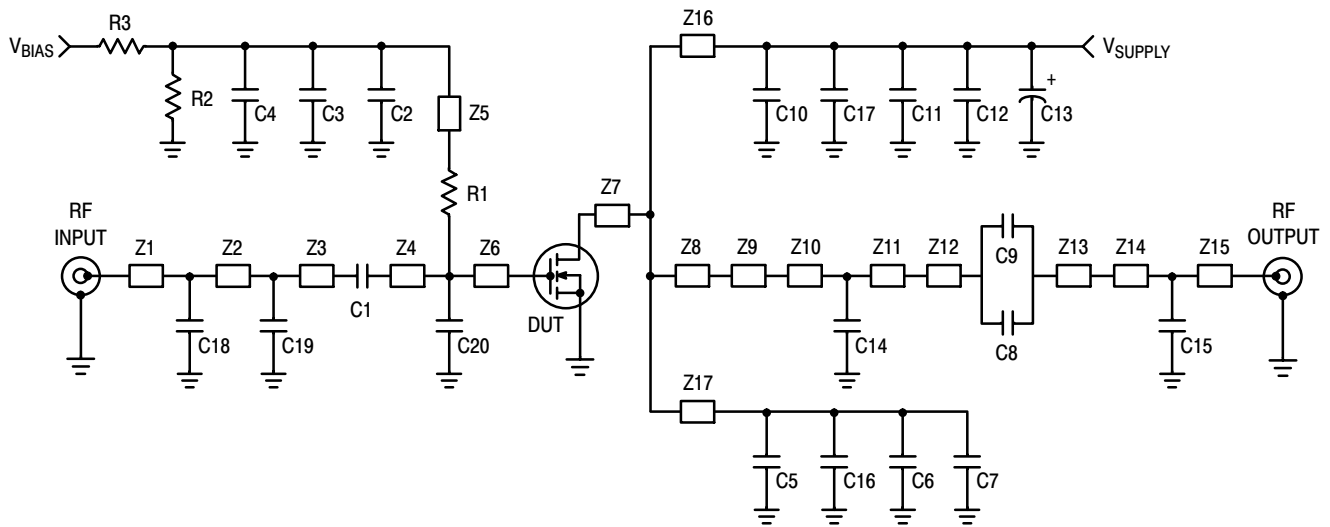

Z1	0.410" x 0.083" Microstrip	Z10*	0.900" x 0.161" Microstrip
Z2*	0.480" x 0.083" Microstrip	Z11*	0.140" x 0.161" Microstrip
Z3*	0.710" x 0.083" Microstrip	Z12	0.094" x 0.220" Microstrip
Z4	0.180" x 0.147" Microstrip	Z13	0.070" x 0.220" Microstrip
Z5	0.850" x 0.091" Microstrip	Z14*	0.140" x 0.083" Microstrip
Z6	0.383" x 1.109" Microstrip	Z15*	0.160" x 0.083" Microstrip
Z7	1.110" x 1.360" Microstrip	Z16, Z17	1.120" x 0.080" Microstrip
Z8	0.480" x 1.360" Microstrip	PCB	Taconic TLX8-0300, 0.030", $\epsilon_r = 2.55$
Z9	0.060" x 1.098" Microstrip		
			* Variable for tuning

Figure 1. MRF7S18170HR3 Test Circuit Schematic — NI-880

Table 5. MRF7S18170HR3 Test Circuit Component Designations and Values — NI-880

Part	Description	Part Number	Manufacturer
C1	0.8 pF Chip Capacitor	100B0R8BW	ATC
C2, C8, C9	6.8 pF Chip Capacitors	100B6R8BW	ATC
C3	100 pF Chip Capacitor	100B101JW	ATC
C4	100 nF Chip Capacitor	100B104JW	ATC
C5, C10	5.6 pF Chip Capacitors	100B5R6BW	ATC
C6, C7, C11, C12	10 μ F Chip Capacitors	C5750X5R1H106MT	TDK
C13	470 μ F, 63 V Electrolytic Capacitor, Radial	13661471	Philips
C14	0.5 pF Chip Capacitor	600B0R5BW	ATC
C15, C20	0.2 pF Chip Capacitors	100B0R2BW	ATC
C16, C17	4.7 pF Chip Capacitors	100B4R7BW	ATC
C18	2 pF Chip Capacitor	600B2R0BW	ATC
C19	0.3 pF Chip Capacitor	100B0R3BW	ATC
R1	10 Ω , 1/4 W Chip Resistor	232272461009	Phycomp
R2, R3	10 k Ω , 1/4 W Chip Resistors	232272461003	Phycomp

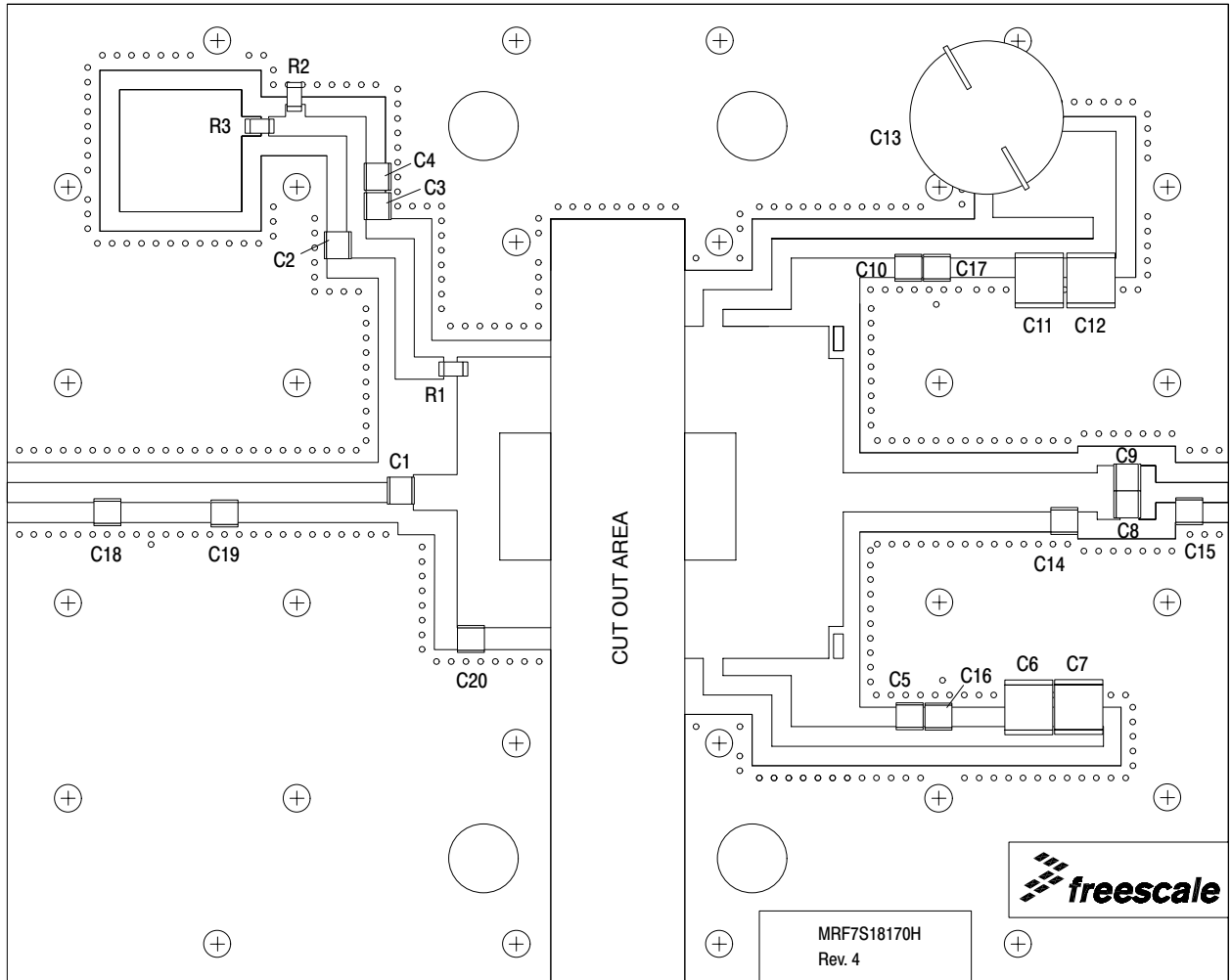
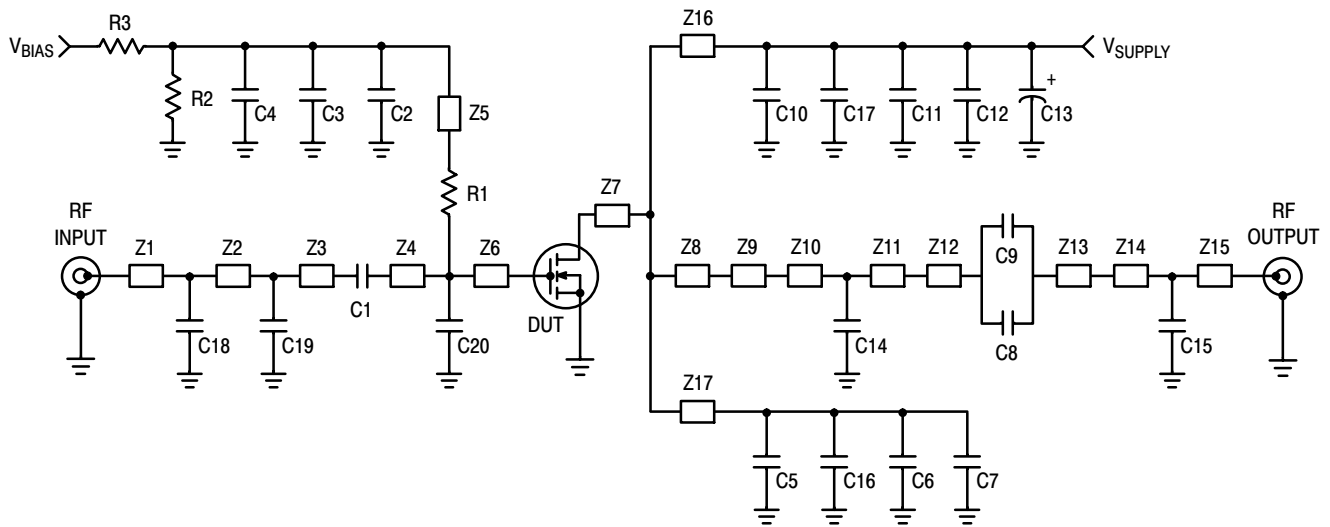

Figure 2. MRF7S18170HR3 Test Circuit Component Layout — NI-880



Z1*	0.500" x 0.083" Microstrip	Z10*	0.900" x 0.161" Microstrip
Z2*	0.290" x 0.083" Microstrip	Z11*	0.140" x 0.161" Microstrip
Z3*	0.810" x 0.083" Microstrip	Z12	0.094" x 0.220" Microstrip
Z4	0.180" x 0.147" Microstrip	Z13	0.070" x 0.220" Microstrip
Z5	0.850" x 0.091" Microstrip	Z14*	0.140" x 0.083" Microstrip
Z6	0.383" x 1.109" Microstrip	Z15*	0.160" x 0.083" Microstrip
Z7	1.110" x 1.360" Microstrip	Z16, Z17	1.120" x 0.080" Microstrip
Z8	0.480" x 1.360" Microstrip	PCB	Taconic TLX8-0300, 0.030", $\epsilon_r = 2.55$
Z9	0.060" x 1.098" Microstrip		
			* Variable for tuning

Figure 3. MRF7S18170HSR3 Test Circuit Schematic — NI-880S

Table 6. MRF7S18170HSR3 Test Circuit Component Designations and Values — NI-880S

Part	Description	Part Number	Manufacturer
C1	0.8 pF Chip Capacitor	100B0R8BW	ATC
C2, C8, C9	6.8 pF Chip Capacitors	100B6R8BW	ATC
C3	100 pF Chip Capacitor	100B101JW	ATC
C4	100 nF Chip Capacitor	100B104JW	ATC
C5, C10	5.6 pF Chip Capacitors	100B5R6BW	ATC
C6, C7, C11, C12	10 μ F Chip Capacitors	C5750X5R1H106MT	TDK
C13	470 μ F, 63 V Electrolytic Capacitor, Radial	13661471	Philips
C14	0.5 pF Chip Capacitor	600B0R5BW	ATC
C15	0.2 pF Chip Capacitor	100B0R2BW	ATC
C16, C17	4.7 pF Chip Capacitors	100B4R7BW	ATC
C18	2 pF Chip Capacitor	600B2R0BW	ATC
C19	0.3 pF Chip Capacitor	100B0R3BW	ATC
C20	0.1 pF Chip Capacitor	100B0R2BW	ATC
R1	10 Ω , 1/4 W Chip Resistor	232272461003	Phycomp
R2, R3	10 k Ω , 1/4 W Chip Resistors	232272461009	Phycomp

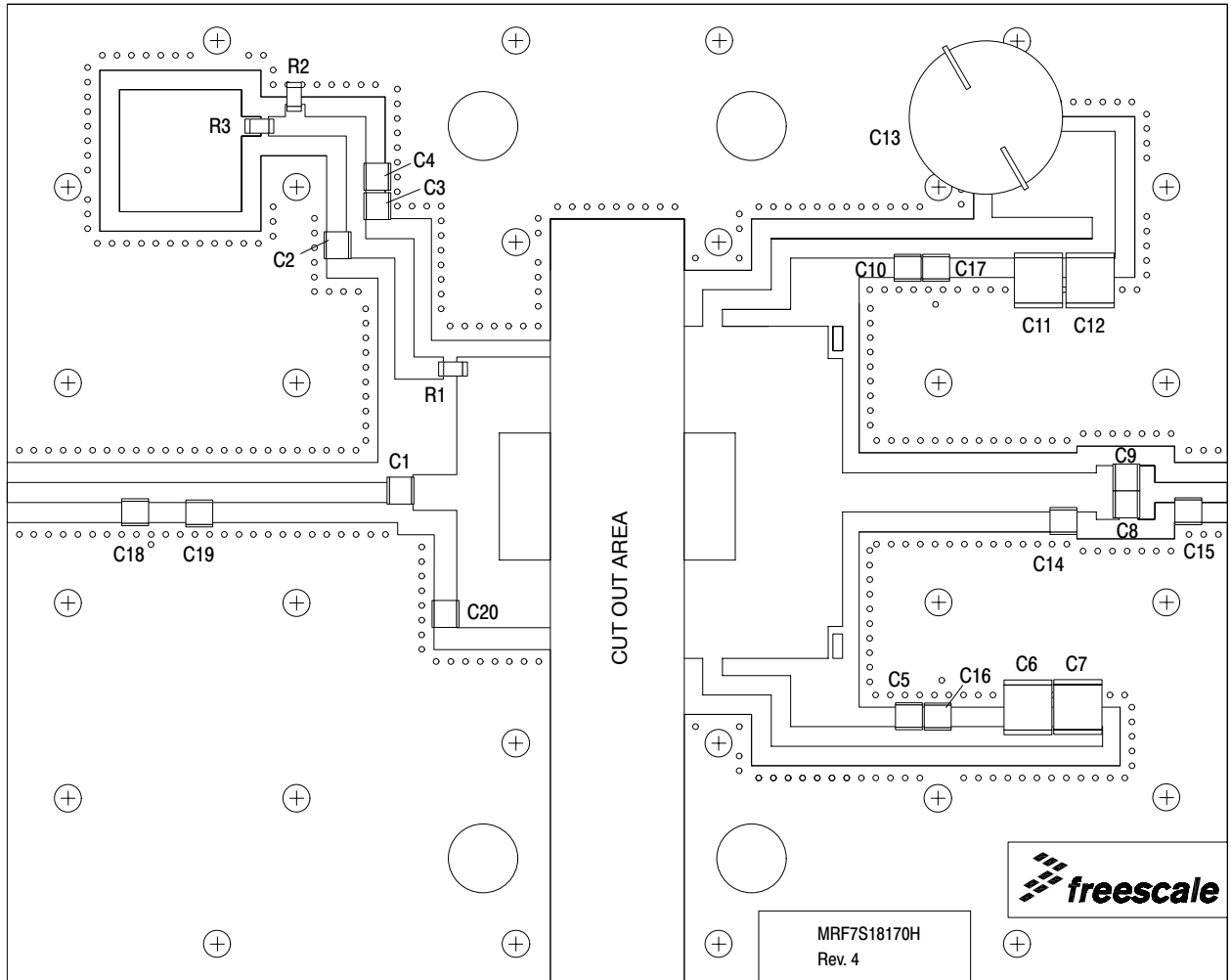

Figure 4. MRF7S18170HSR3 Test Circuit Component Layout — NI-880S

TYPICAL CHARACTERISTICS

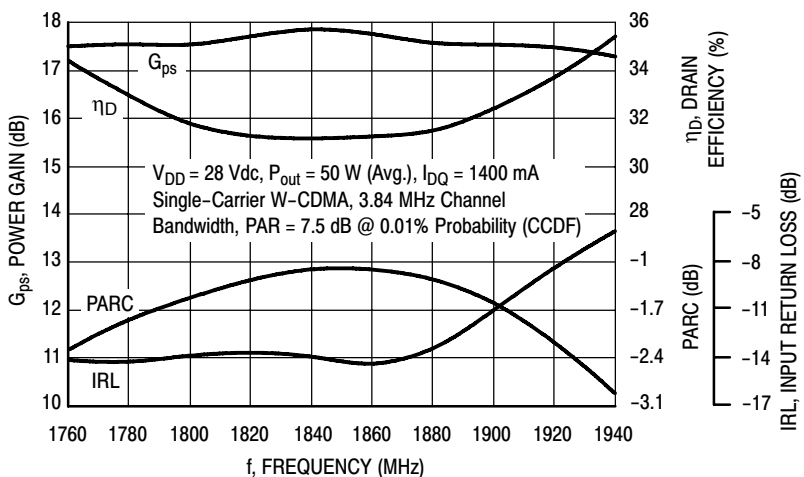

Figure 5. Output Peak-to-Average Ratio Compression (PARC) Broadband Performance @ $P_{out} = 50$ Watts Avg.

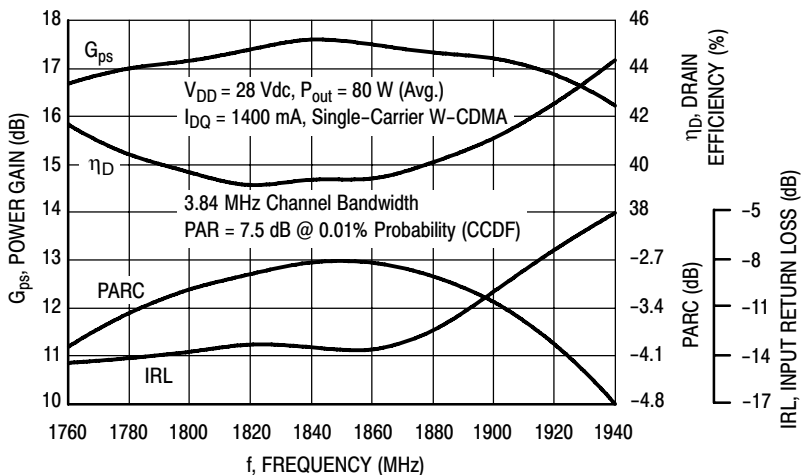

Figure 6. Output Peak-to-Average Ratio Compression (PARC) Broadband Performance @ $P_{out} = 80$ Watts Avg.

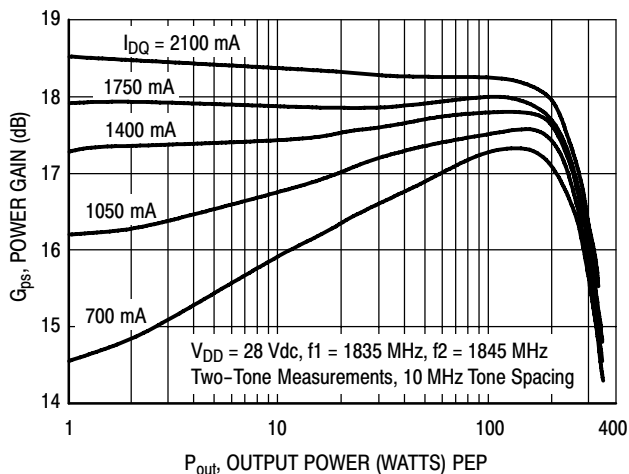

Figure 7. Two-Tone Power Gain versus Output Power

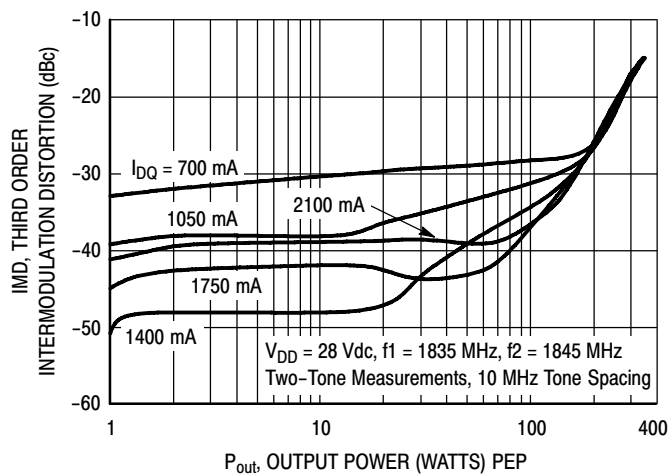

Figure 8. Third Order Intermodulation Distortion versus Output Power

TYPICAL CHARACTERISTICS

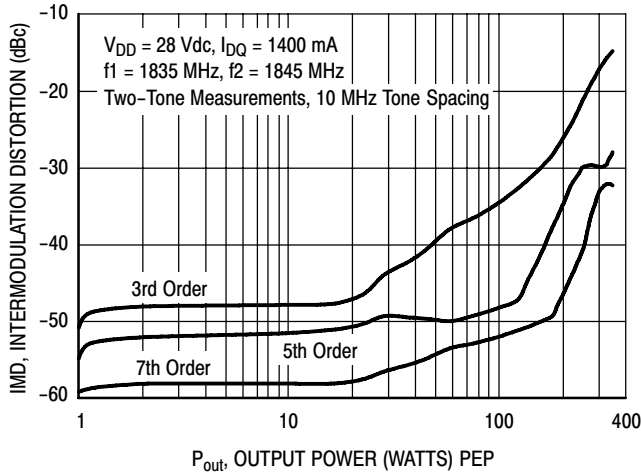

Figure 9. Intermodulation Distortion Products versus Output Power

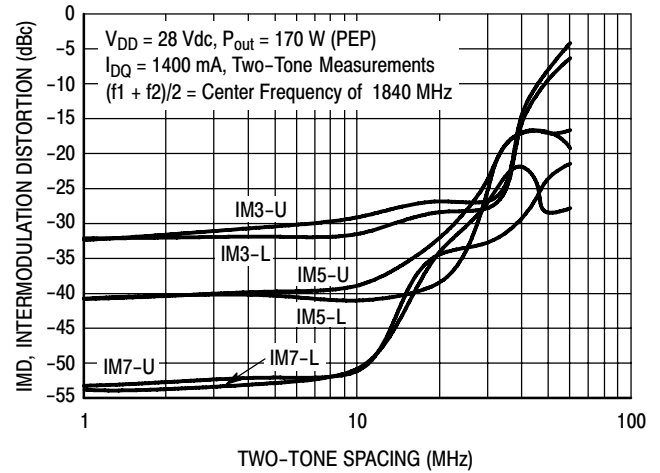

Figure 10. Intermodulation Distortion Products versus Tone Spacing

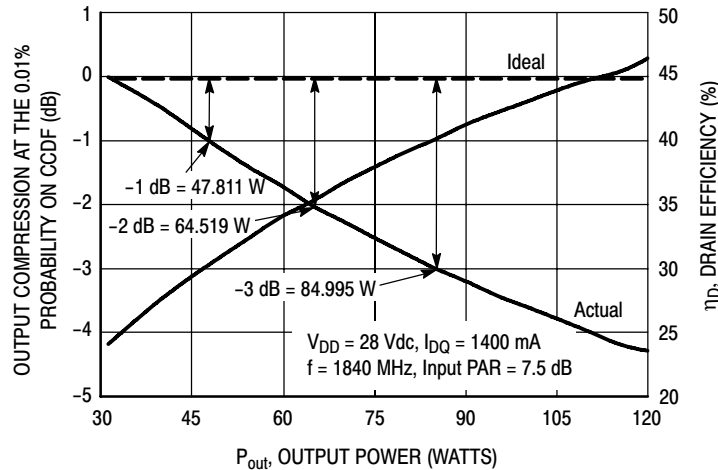

Figure 11. Output Peak-to-Average Ratio Compression (PARC) versus Output Power

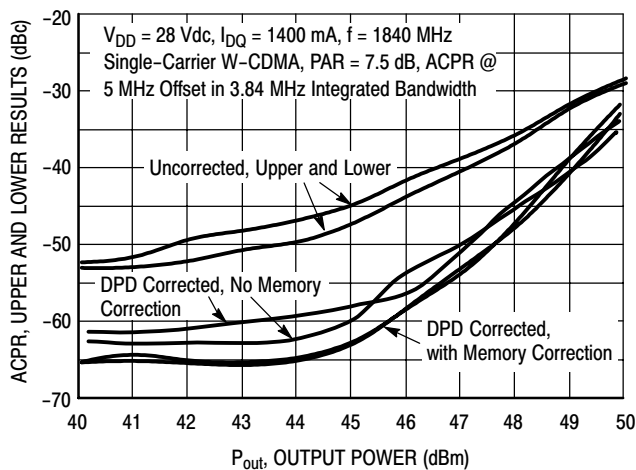

Figure 12. Digital Predistortion Correction versus ACPR and Output Power

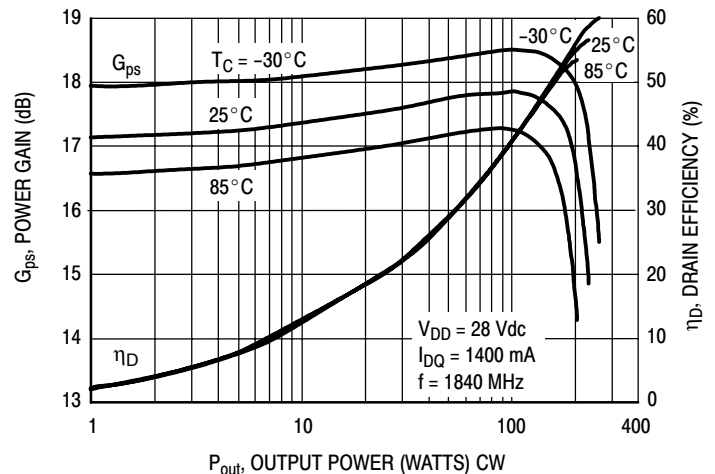

Figure 13. Power Gain and Drain Efficiency versus CW Output Power

MRF7S18170HR3 MRF7S18170HSR3

TYPICAL CHARACTERISTICS

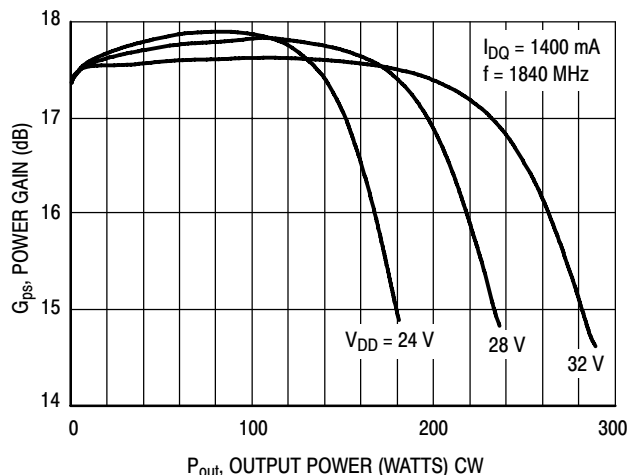
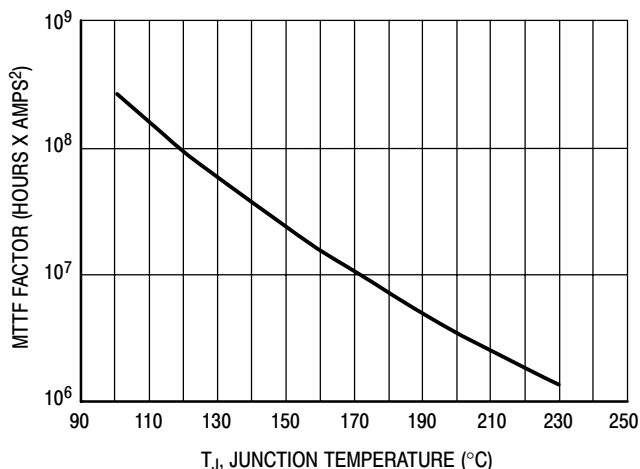

Figure 14. Power Gain versus Output Power



This above graph displays calculated MTTF in hours x ampere² drain current. Life tests at elevated temperatures have correlated to better than $\pm 10\%$ of the theoretical prediction for metal failure. Divide MTTF factor by I_D^2 for MTTF in a particular application.

Figure 15. MTTF Factor versus Junction Temperature

W-CDMA TEST SIGNAL

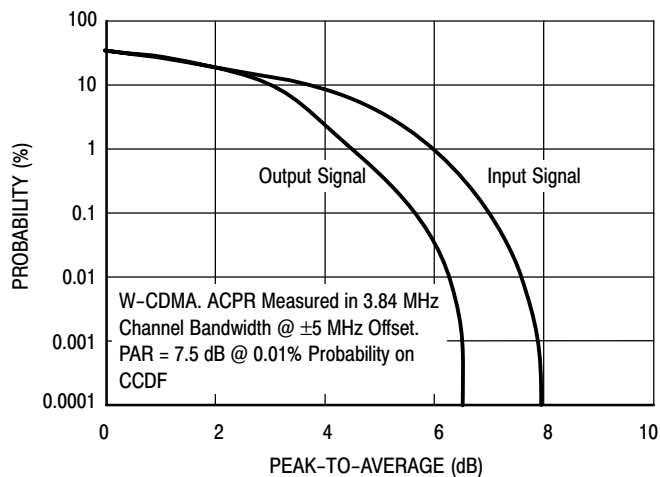

Figure 16. CCDF W-CDMA 3GPP, Test Model 1, 64 DPCH, 50% Clipping, Single-Carrier Test Signal

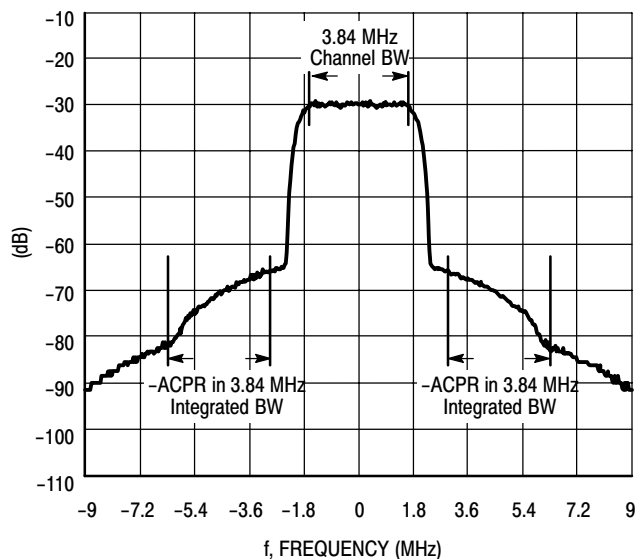
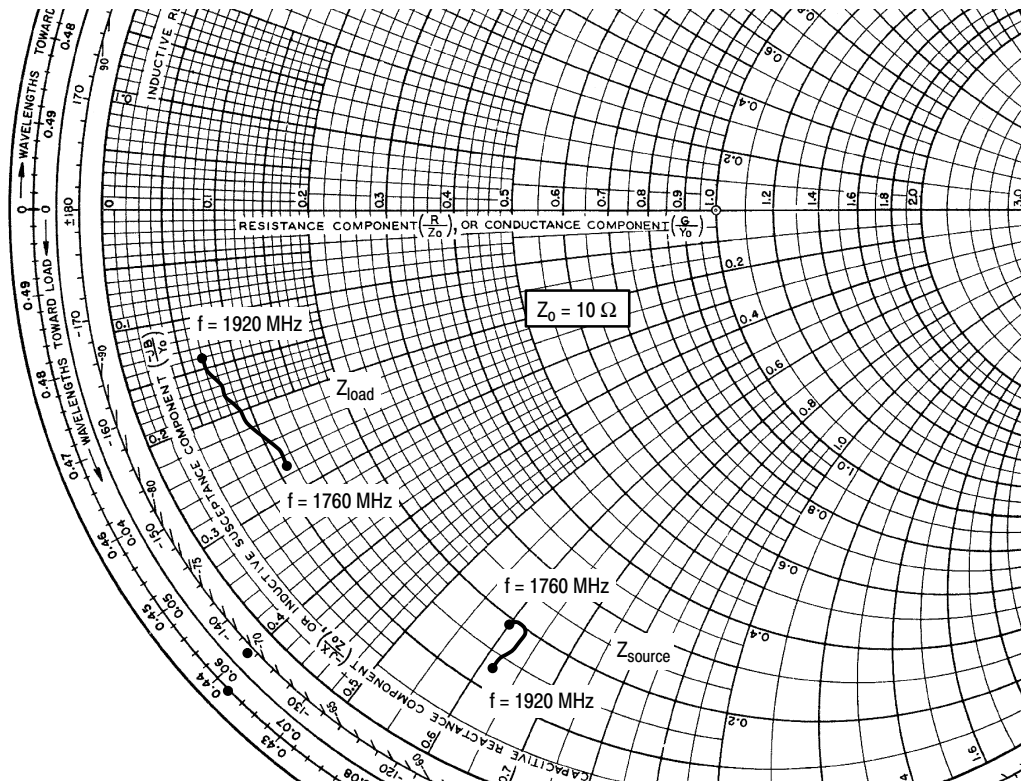

Figure 17. Single-Carrier W-CDMA Spectrum



$V_{DD} = 28 \text{ Vdc}$, $I_{DQ} = 1400 \text{ mA}$, $P_{out} = 50 \text{ W Avg.}$

f MHz	Z_{source} Ω	Z_{load} Ω
1760	$1.93 - j6.00$	$1.13 - j2.65$
1780	$1.95 - j6.10$	$1.05 - j2.45$
1800	$1.99 - j6.18$	$0.97 - j2.29$
1820	$1.95 - j6.22$	$0.90 - j2.12$
1840	$1.85 - j6.30$	$0.85 - j2.00$
1860	$1.71 - j6.26$	$0.81 - j1.84$
1880	$1.55 - j6.25$	$0.75 - j1.70$
1900	$1.39 - j6.20$	$0.70 - j1.54$
1920	$1.23 - j6.15$	$0.67 - j1.38$

Z_{source} = Test circuit impedance as measured from gate to ground.

Z_{load} = Test circuit impedance as measured from drain to ground.

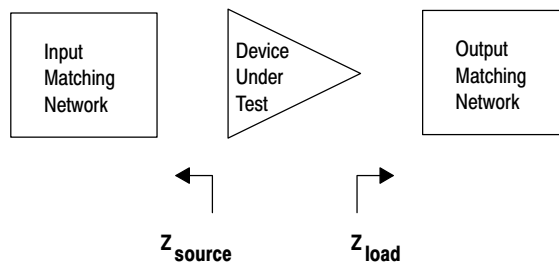
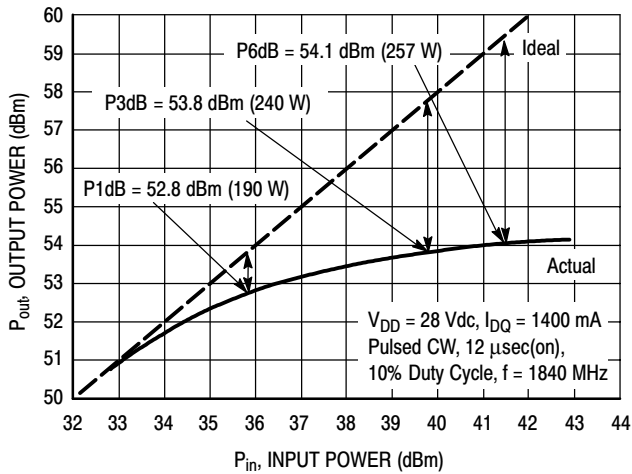

Figure 18. Series Equivalent Source and Load Impedance

ALTERNATIVE PEAK TUNE LOAD PULL CHARACTERISTICS



Test Impedances per Compression Level

	Z_{source} Ω	Z_{load} Ω
3dB	1.23 - j7.91	0.88 - j2.81

Figure 19. Pulsed CW Output Power versus Input Power

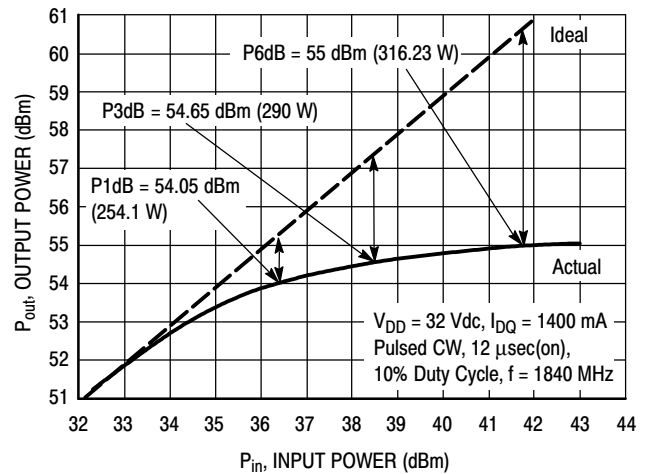

Test Impedances per Compression Level

	Z_{source} Ω	Z_{load} Ω
P3dB	1.23 - j7.91	1.03 - j2.65

Figure 20. Pulsed CW Output Power versus Input Power

PACKAGE DIMENSIONS

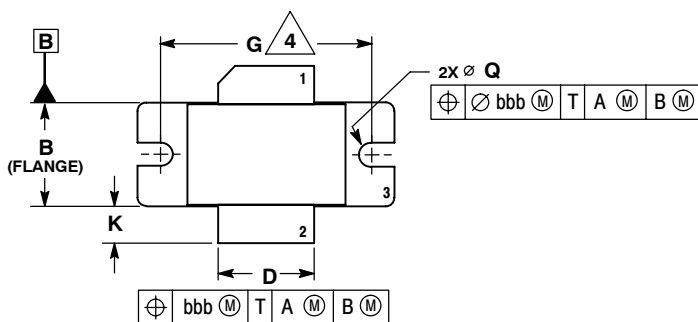

- NOTES:
1. DIMENSIONING AND TOLERANCING PER ANSI Y14.5M-1994.
 2. CONTROLLING DIMENSION: INCH.
 3. DIMENSION H IS MEASURED 0.030 (0.762) AWAY FROM PACKAGE BODY.
 4. RECOMMENDED BOLT CENTER DIMENSION OF 1.16 (29.57) BASED ON M3 SCREW.

DIM	INCHES		MILLIMETERS	
	MIN	MAX	MIN	MAX
A	1.335	1.345	33.91	34.16
B	0.535	0.545	13.6	13.8
C	0.147	0.200	3.73	5.08
D	0.495	0.505	12.57	12.83
E	0.035	0.045	0.89	1.14
F	0.003	0.006	0.08	0.15
G	1.100 BSC		27.94 BSC	
H	0.057	0.067	1.45	1.70
K	0.175	0.205	4.44	5.21
M	0.872	0.888	22.15	22.55
N	0.871	0.889	19.30	22.60
Q	Ø 0.118	Ø 0.138	Ø 3.00	Ø 3.51
R	0.515	0.525	13.10	13.30
S	0.515	0.525	13.10	13.30
aaa	0.007 REF		0.178 REF	
bbb	0.010 REF		0.254 REF	
ccc	0.015 REF		0.381 REF	

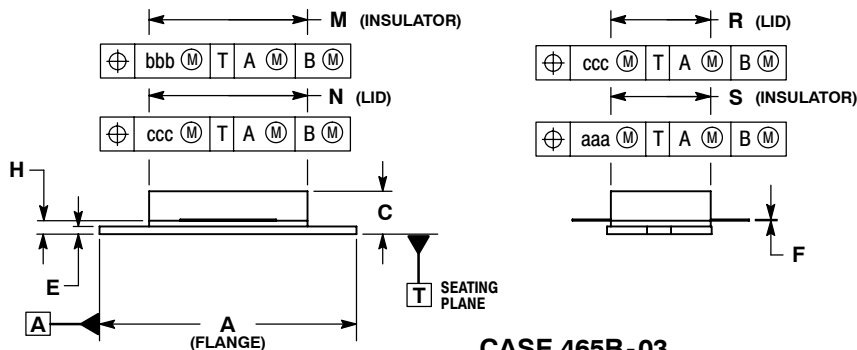

- STYLE 1:
 PIN 1. DRAIN
 2. GATE
 3. SOURCE

**CASE 465B-03
 ISSUE D
 NI-880
 MRF7S18170HR3**

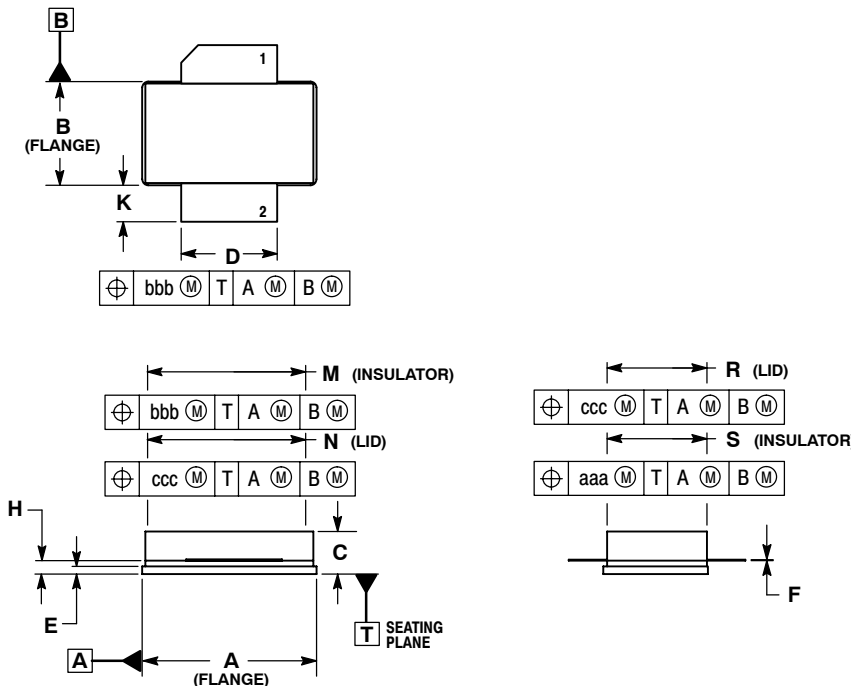

- NOTES:
1. DIMENSIONING AND TOLERANCING PER ANSI Y14.5M-1994.
 2. CONTROLLING DIMENSION: INCH.
 3. DIMENSION H IS MEASURED 0.030 (0.762) AWAY FROM PACKAGE BODY.

DIM	INCHES		MILLIMETERS	
	MIN	MAX	MIN	MAX
A	0.905	0.915	22.99	23.24
B	0.535	0.545	13.60	13.80
C	0.147	0.200	3.73	5.08
D	0.495	0.505	12.57	12.83
E	0.035	0.045	0.89	1.14
F	0.003	0.006	0.08	0.15
H	0.057	0.067	1.45	1.70
K	0.170	0.210	4.32	5.33
M	0.872	0.888	22.15	22.55
N	0.871	0.889	19.30	22.60
R	0.515	0.525	13.10	13.30
S	0.515	0.525	13.10	13.30
aaa	0.007 REF		0.178 REF	
bbb	0.010 REF		0.254 REF	
ccc	0.015 REF		0.381 REF	

- STYLE 1:
 PIN 1. DRAIN
 2. GATE
 3. SOURCE

**CASE 465C-02
 ISSUE D
 NI-880S
 MRF7S18170HSR3**

MRF7S18170HR3 MRF7S18170HSR3

PRODUCT DOCUMENTATION

Refer to the following documents to aid your design process.

Application Notes

- AN1955: Thermal Measurement Methodology of RF Power Amplifiers

Engineering Bulletins

- EB212: Using Data Sheet Impedances for RF LDMOS Devices

REVISION HISTORY

The following table summarizes revisions to this document.

Revision	Date	Description
0	Oct. 2006	<ul style="list-style-type: none">• Initial Release of Data Sheet

How to Reach Us:

Home Page:

www.freescale.com

E-mail:

support@freescale.com

USA/Europe or Locations Not Listed:

Freescale Semiconductor, Inc.
Technical Information Center, EL516
2100 East Elliot Road
Tempe, Arizona 85284
+1-800-521-6274 or +1-480-768-2130
www.freescale.com/support

Europe, Middle East, and Africa:

Freescale Halbleiter Deutschland GmbH
Technical Information Center
Schatzbogen 7
81829 Muenchen, Germany
+44 1296 380 456 (English)
+46 8 52200080 (English)
+49 89 92103 559 (German)
+33 1 69 35 48 48 (French)
www.freescale.com/support

Japan:

Freescale Semiconductor Japan Ltd.
Headquarters
ARCO Tower 15F
1-8-1, Shimo-Meguro, Meguro-ku,
Tokyo 153-0064
Japan
0120 191014 or +81 3 5437 9125
support.japan@freescale.com

Asia/Pacific:

Freescale Semiconductor Hong Kong Ltd.
Technical Information Center
2 Dai King Street
Tai Po Industrial Estate
Tai Po, N.T., Hong Kong
+800 2666 8080
support.asia@freescale.com

For Literature Requests Only:

Freescale Semiconductor Literature Distribution Center
P.O. Box 5405
Denver, Colorado 80217
1-800-441-2447 or 303-675-2140
Fax: 303-675-2150
LDCForFreescaleSemiconductor@hibbertgroup.com

Information in this document is provided solely to enable system and software implementers to use Freescale Semiconductor products. There are no express or implied copyright licenses granted hereunder to design or fabricate any integrated circuits or integrated circuits based on the information in this document.

Freescale Semiconductor reserves the right to make changes without further notice to any products herein. Freescale Semiconductor makes no warranty, representation or guarantee regarding the suitability of its products for any particular purpose, nor does Freescale Semiconductor assume any liability arising out of the application or use of any product or circuit, and specifically disclaims any and all liability, including without limitation consequential or incidental damages. "Typical" parameters that may be provided in Freescale Semiconductor data sheets and/or specifications can and do vary in different applications and actual performance may vary over time. All operating parameters, including "Typicals", must be validated for each customer application by customer's technical experts. Freescale Semiconductor does not convey any license under its patent rights nor the rights of others. Freescale Semiconductor products are not designed, intended, or authorized for use as components in systems intended for surgical implant into the body, or other applications intended to support or sustain life, or for any other application in which the failure of the Freescale Semiconductor product could create a situation where personal injury or death may occur. Should Buyer purchase or use Freescale Semiconductor products for any such unintended or unauthorized application, Buyer shall indemnify and hold Freescale Semiconductor and its officers, employees, subsidiaries, affiliates, and distributors harmless against all claims, costs, damages, and expenses, and reasonable attorney fees arising out of, directly or indirectly, any claim of personal injury or death associated with such unintended or unauthorized use, even if such claim alleges that Freescale Semiconductor was negligent regarding the design or manufacture of the part.

Freescale™ and the Freescale logo are trademarks of Freescale Semiconductor, Inc. All other product or service names are the property of their respective owners.
© Freescale Semiconductor, Inc. 2006. All rights reserved.

