

NCV4274, NCV4274A

400 mA 2% and 4% Voltage Regulator Family

Description

The NCV4274 and NCV4274A is a precision micro-power voltage regulator with an output current capability of 400 mA available in the DPAK and D2PAK packages.

The output voltage is accurate within $\pm 2.0\%$ or $\pm 4.0\%$ depending on the version with a maximum dropout voltage of 0.5 V with an input up to 40 V. Low quiescent current is a feature drawing only 150 μA with a 1 mA load. This part is ideal for automotive and all battery operated microprocessor equipment.

The regulator is protected against reverse battery, short circuit, and thermal overload conditions. The device can withstand load dump transients making it suitable for use in automotive environments.

Features

- 2.5, 3.3 V, 5.0 V, $\pm 2.0\%$ and $\pm 4.0\%$ Output Options
- Low 150 μA Quiescent Current at 1 mA load current
- 400 mA Output Current Capability
- Fault Protection
- +60 V Peak Transient Voltage with Respect to GND
- -40 V Reverse Voltage
- Short Circuit
- Thermal Overload
- Very Low Dropout Voltage
- Electrical Parameters Guaranteed Over Entire Temperature Range
- NCV Prefix for Automotive and Other Applications Requiring Site and Control Changes
- These are Pb-Free Devices



ON Semiconductor®

<http://onsemi.com>

MARKING DIAGRAMS

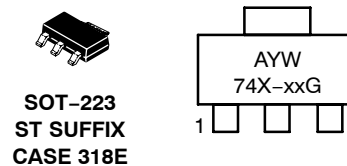
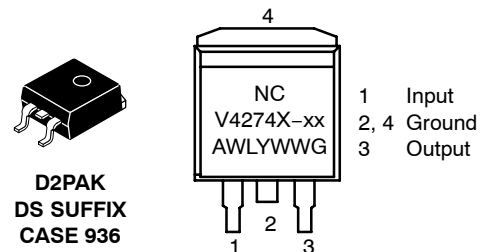
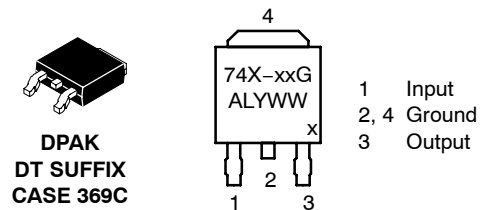

X = A or blank
xx = Voltage Ratings
A = Assembly Location
L, WL = Wafer Lot
Y = Year
WW, W = Work Week
G = Pb-Free Package

ORDERING INFORMATION

See detailed ordering and shipping information in the package dimensions section on page 13 of this data sheet.

NCV4274, NCV4274A

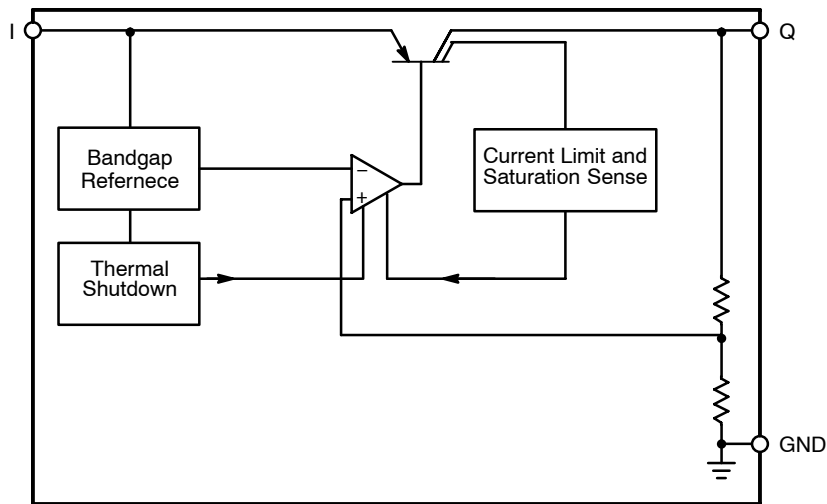

Figure 1. Block Diagram

Pin Definitions and Functions

Pin No.	Symbol	Function
1	I	Input; Bypass directly at the IC a ceramic capacitor to GND.
2,4	GND	Ground
3	Q	Output; Bypass with a capacitor to GND.

1. DPAK 3LD package code 6025
2. D2PAK 3LD package code 6083

ABSOLUTE MAXIMUM RATINGS

Pin Symbol, Parameter		Symbol	Condition	Min	Max	Unit
I, Input-to-Regulator	Voltage	V_I		-42	45	V
	Current	I_I		Internally Limited	Internally Limited	
I, Input peak Transient Voltage to Regulator with Respect to GND		V_I			60	V
Q, Regulated Output	Voltage	V_Q		-1.0	40	V
	Current	I_Q		Internally Limited	Internally Limited	
GND, Ground Current		I_{GND}		-	100	mA
Junction Temperature		T_J		-	150	°C
Storage Temperature		T_{Stg}		-50	150	°C
ESD Capability, Human Body Model		ESD_{HB}		4		kV
ESD Capability, Machine Model		ESD_{MM}		200		V
ESD Capability, Charged Device Model		ESD_{CDM}		1		kV

Stresses exceeding Maximum Ratings may damage the device. Maximum Ratings are stress ratings only. Functional operation above the Recommended Operating Conditions is not implied. Extended exposure to stresses above the Recommended Operating Conditions may affect device reliability.

3. This device series incorporates ESD protection and is tested by the following methods:
 ESD HBM tested per AEC-Q100-002 (EIA/JESD22-A114)
 ESD MM tested per AEC-Q100-003 (EIA/JESD22-A115)
 ESD CDM tested per EIA/JES D22/C101, Field Induced Charge Model
4. Latchup Current Maximum Rating: ≤ 150 mA per JEDEC standard: JESD78.

NCV4274, NCV4274A

OPERATING RANGE

Parameter	Symbol	Condition	Min	Max	Unit
Input Voltage (5.0 V Version)	V_I		5.5	40	V
Input Voltage (3.3 V, and 2.5 V Version)	V_I		4.5	40	V
Junction Temperature	T_J		-40	150	°C

THERMAL RESISTANCE

Parameter	Symbol	Condition	Min	Max	Unit
Junction-to-Ambient DPAK	R_{thja}		-	70 (Note 6)	°C/W
Junction-to-Ambient D2PAK	R_{thja}		-	60 (Note 6)	°C/W
Junction-to-Case DPAK	R_{thjc}		-	4	°C/W
Junction-to-Case D2PAK	R_{thjc}		-	3	°C/W
Junction-to-Tab SOT-223	Ψ_{-JLX} , Ψ_{LX}		-	14.5 (Note 7)	°C/W
Junction-to-Ambient SOT-223	$R_{\theta JA}$, θ_{JA}		-	169.7 (Note 7)	°C/W

5. Soldered in, 1 cm² copper area at Pin 4, FR4

6. Soldered in, minimal footprint, FR4

7. 1 oz copper, 5 mm² copper area, FR4

LEAD SOLDERING TEMPERATURE AND MSL

Parameter	Symbol	Condition	Min	Max	Unit
Lead Temperature Soldering, (Note 8) Reflow (SMD styles only), Pb Pb-Free	T_{sld}	60s – 150s Above 183s 30s Max at Peak 60s – 150s Above 217s 40s Max at Peak	-	240 pk 265 pk	°C
Moisture Sensitivity Level	MSL		1	-	

8. Per IPC/JEDEC J-STD-020C

NCV4274, NCV4274A

ELECTRICAL CHARACTERISTICS NCV4274A and NCV4274 5.0 V

-40°C < T_J < 150°C; V_I = 13.5 V unless otherwise noted.

Parameter	Symbol	Test Conditions	Min	Typ	Max	Min	Typ	Max	Unit
			NCV4274A			NCV4274			
REGULATOR									
Output Voltage (5.0 V Version)	V _Q	5 mA < I _Q < 400 mA 6V < V _I < 28 V	4.9	5.0	5.1	4.8	5.0	5.2	V
Output Voltage (5.0 V Version)	V _Q	5 mA < I _Q < 200 mA 6 V < V _I < 40 V	4.9	5.0	5.1	4.8	5.0	5.2	V
Output Voltage (3.3 V Version)	V _Q	5 mA < I _Q < 400 mA 4.5 V < V _I < 28 V	3.23	3.3	3.37	3.17	3.3	3.43	V
Output Voltage (3.3 V Version)	V _Q	5 mA < I _Q < 200 mA 4.5 V < V _I < 40 V	3.23	3.3	3.37	3.17	3.3	3.43	V
Output Voltage (2.5 V Version)	V _Q	5 mA < I _Q < 400 mA 4.5 V < V _I < 28 V	2.45	2.5	2.55	2.4	2.5	2.6	V
Output Voltage (2.5 V Version)	V _Q	5 mA < I _Q < 200 mA 4.5 V < V _I < 40 V	2.45	2.5	2.55	2.4	2.5	2.6	V
Current Limit	I _Q	-	400	600	-	400	600	-	mA
Quiescent Current	I _q	I _q = 1 mA V _Q = 5.0 V V _Q = 3.3 V V _Q = 2.5 V	-	190	250	-	190	250	μA
			-	145	250	-	145	250	μA
			-	140	250	-	140	250	μA
		I _q = 250 mA V _Q = 5.0 V V _Q = 3.3 V V _Q = 2.5 V	-	10	15	-	10	15	mA
			-	13	20	-	13	20	mA
			-	12	15	-	12	15	mA
		I _q = 400 mA V _Q = 5.0 V V _Q = 3.3 V V _Q = 2.5 V	-	20	35	-	20	35	mA
-	30		45	-	30	45	mA		
-	28		35	-	28	35	mA		
Dropout Voltage 5.0 V Version 3.3 V Version 2.5 V Version	V _{DR}	I _Q = 250 mA, V _{DR} = V _I - V _Q V _I = 5.0 V V _I = 4.5 V V _I = 4.5 V	-	250	500	-	250	500	mV
			-	-	1.23	-	-	1.33	V
			-	-	2.05	-	-	2.1	V
			-	-	-	-	-	-	-
Load Regulation	DV _Q	I _Q = 5 mA to 400 mA	-	7	20	-	7	30	mV
Line Regulation	DV _Q	DV _I = 12 V to 32 V I _Q = 5 mA	-	10	25	-	10	25	mV
Power Supply Ripple Rejection	P _{SR}	f _r = 100 Hz, V _r = 0.5 V _{PP}	-	60	-	-	60	-	dB
Temperature output voltage drift	dV _Q /dT		-	0.5	-	-	0.5	-	mV/K
Thermal Shutdown Temperature*	T _{SD}	I _Q = 5 mA	150	-	210	150	-	210	°C

*Guaranteed by design, not tested in production

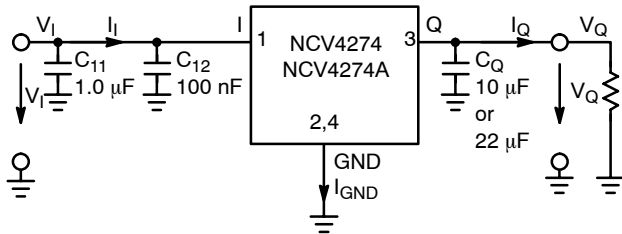

Figure 2. Measuring Circuit

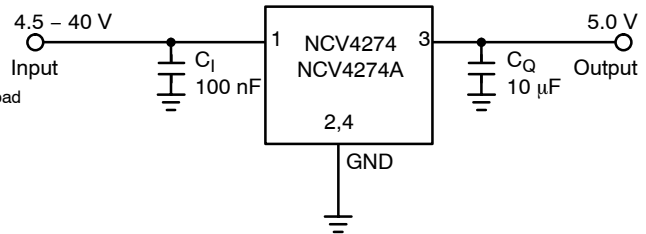

Figure 3. Application Circuit

NCV4274, NCV4274A

TYPICAL CHARACTERISTIC CURVES

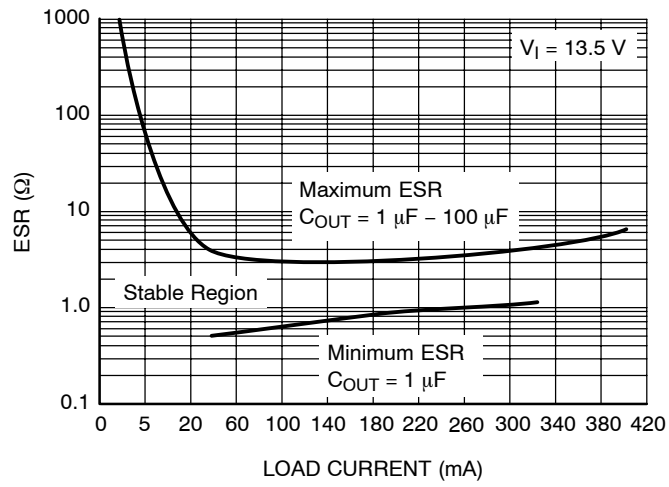

Figure 4. ESR Characterization

NCV4274, NCV4274A

TYPICAL CHARACTERISTIC CURVES – 5.0 V Version

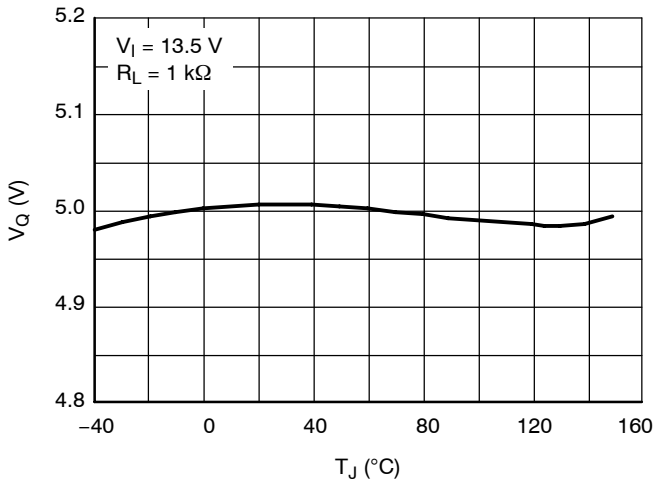

Figure 5. Output Voltage vs. Junction Temperature

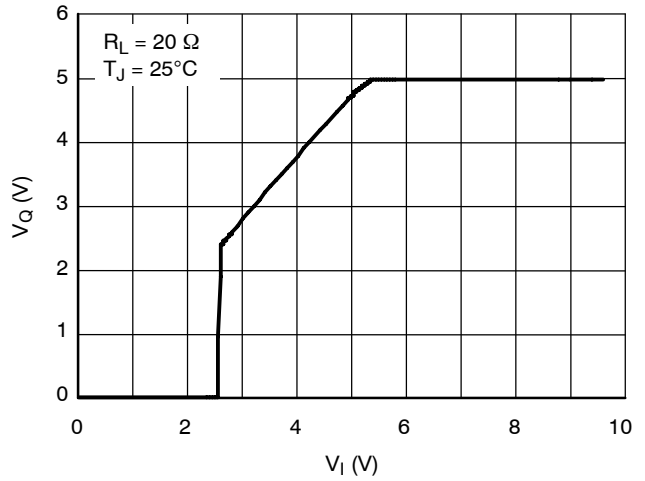

Figure 6. Output Voltage vs. Input Voltage

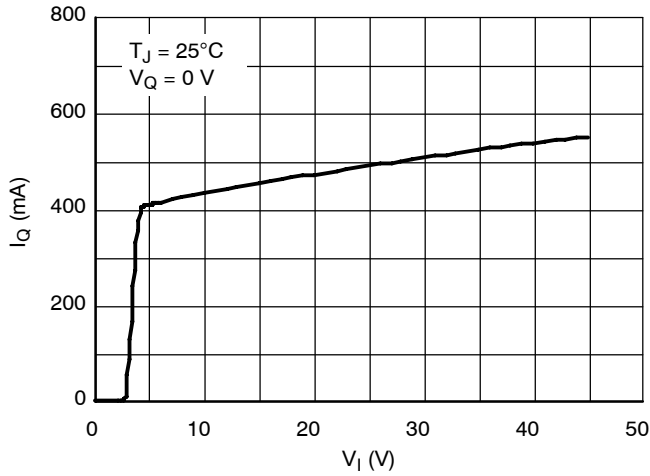

Figure 7. Output Current vs. Input Voltage

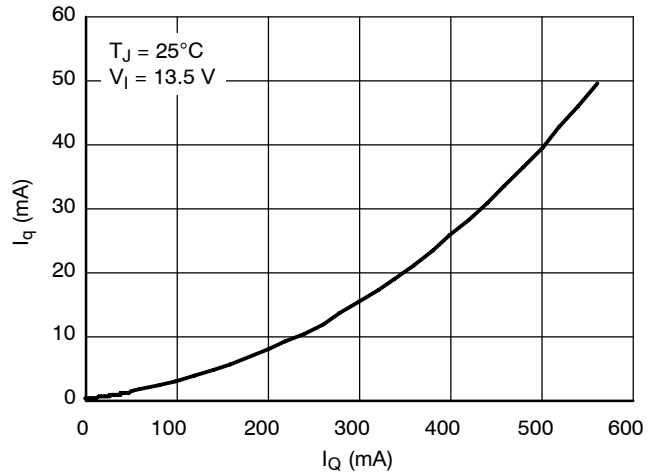

Figure 8. Current Consumption vs. Output Current (High Load)

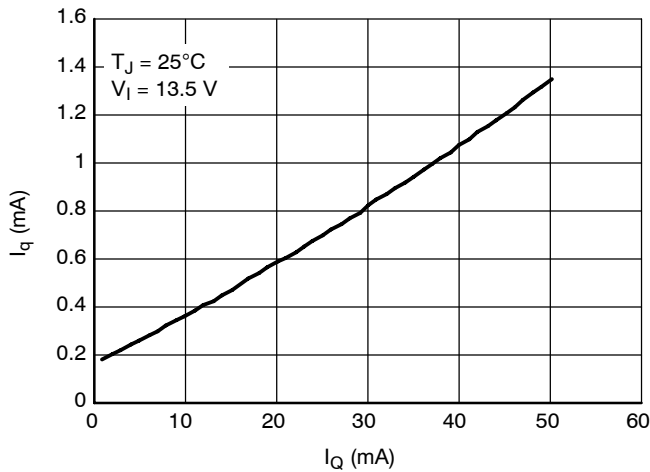

Figure 9. Current Consumption vs. Output Current (Low Load)

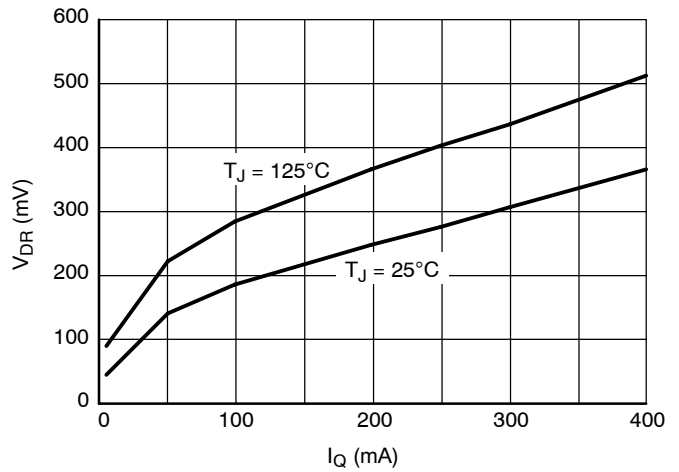

Figure 10. Drop Voltage vs. Output Current

NCV4274, NCV4274A

TYPICAL CHARACTERISTIC CURVES – 5.0 V Version

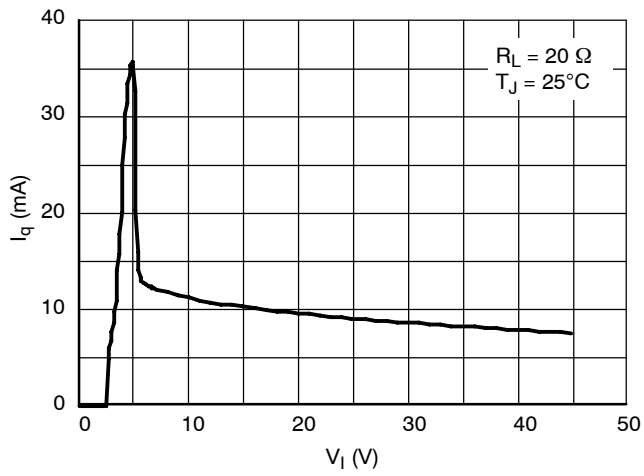

Figure 11. Current Consumption vs. Input Voltage

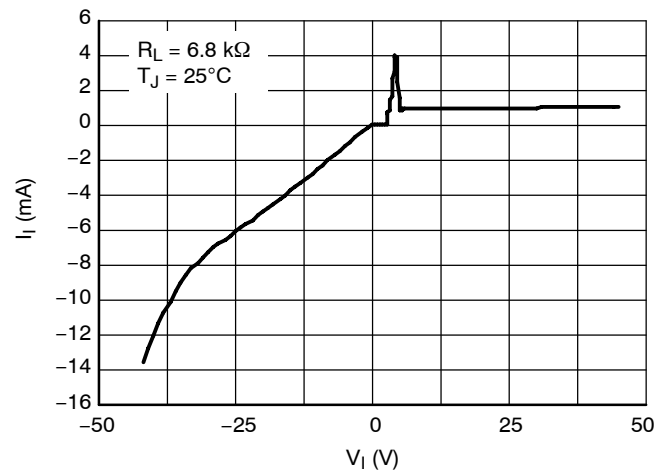

Figure 12. Input Current vs. Input Voltage

TYPICAL CHARACTERISTIC CURVES – 3.3 V Version

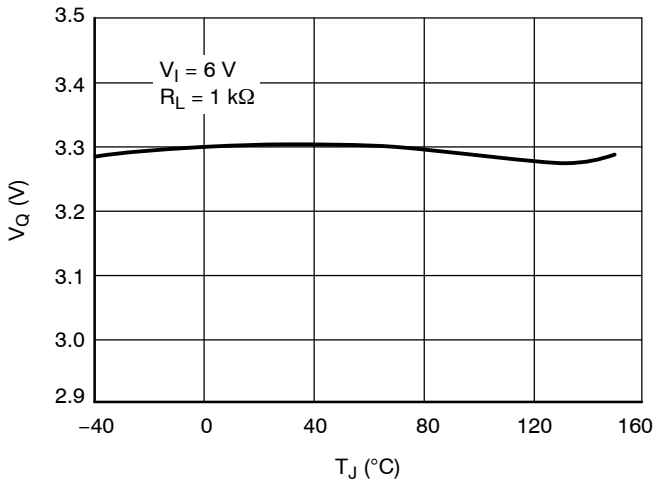

Figure 13. Output Voltage vs. Junction Temperature

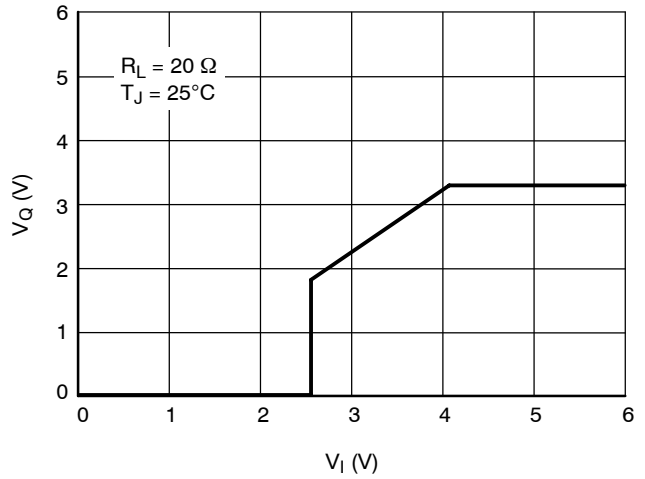

Figure 14. Output Voltage vs. Input Voltage

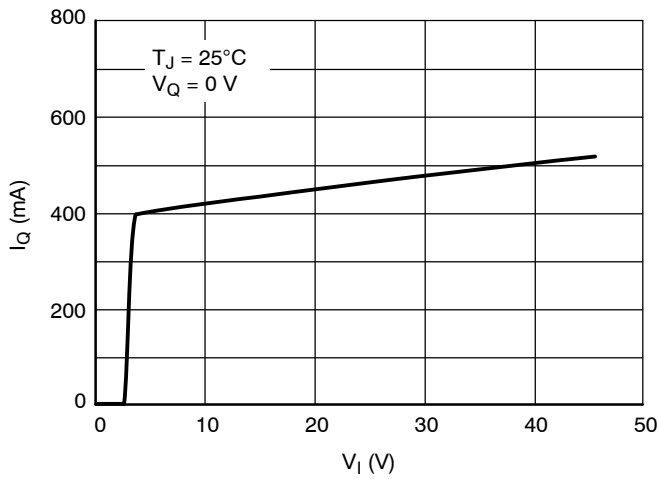

Figure 15. Output Current vs. Input Voltage

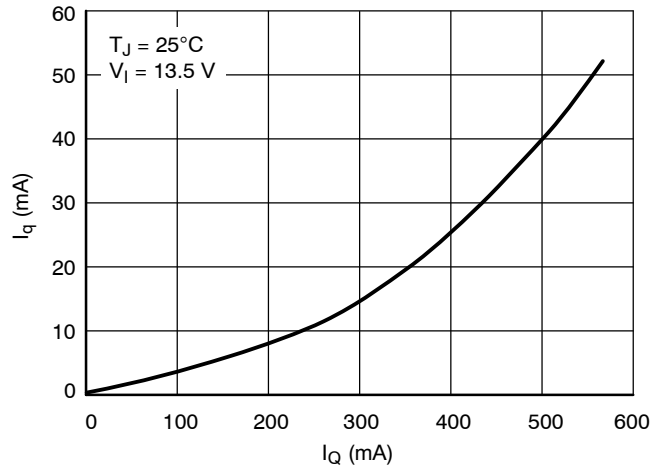

Figure 16. Current Consumption vs. Output Current (High Load)

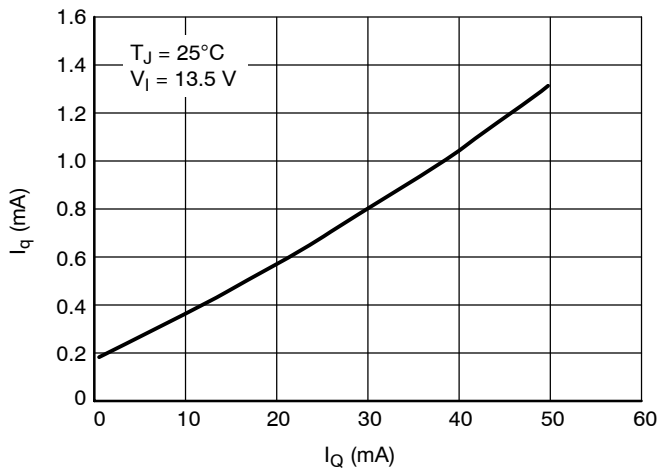

Figure 17. Current Consumption vs. Output Current (Low Load)

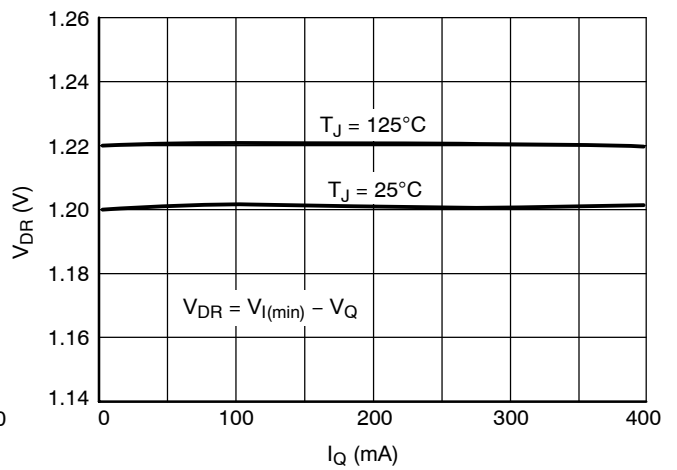

Figure 18. Voltage Drop vs. Output Current

NCV4274, NCV4274A

TYPICAL CHARACTERISTIC CURVES – 3.3 V Version

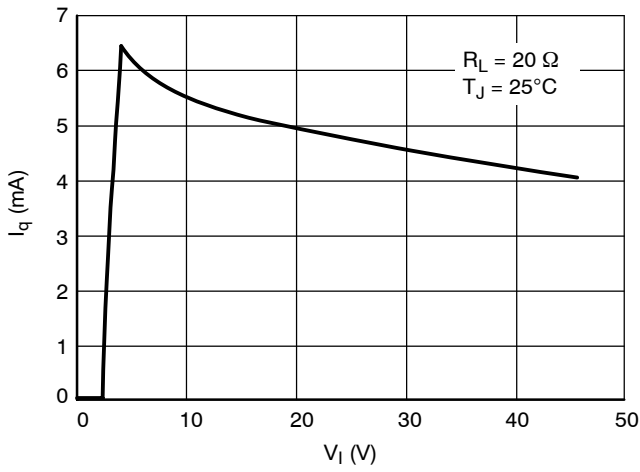

Figure 19. Current Consumption vs. Input Voltage

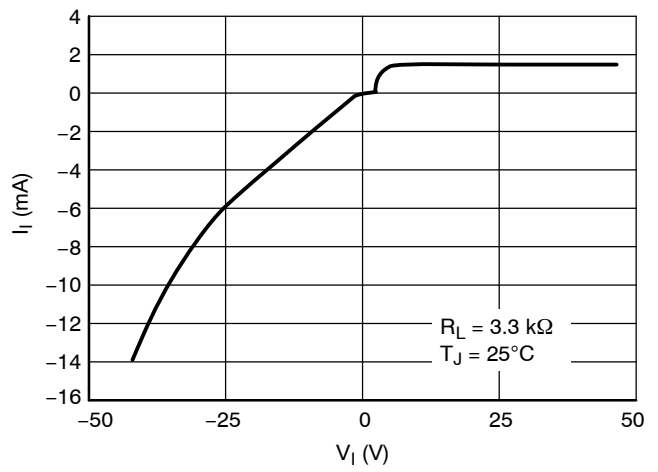

Figure 20. Input Current vs. Input Voltage

NCV4274, NCV4274A

TYPICAL CHARACTERISTIC CURVES – 2.5 V Version

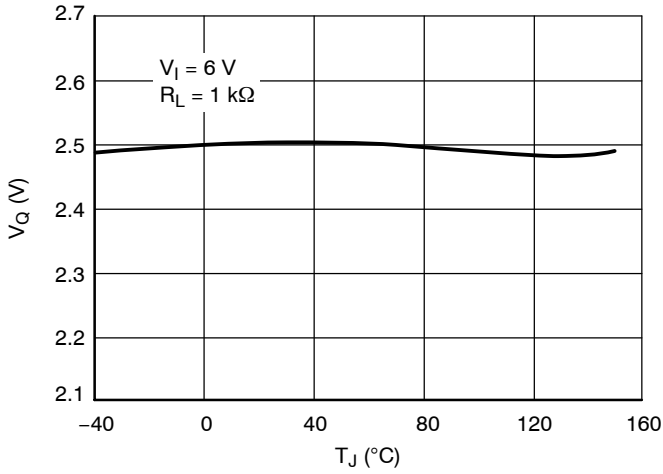

Figure 21. Output Voltage vs. Junction Temperature

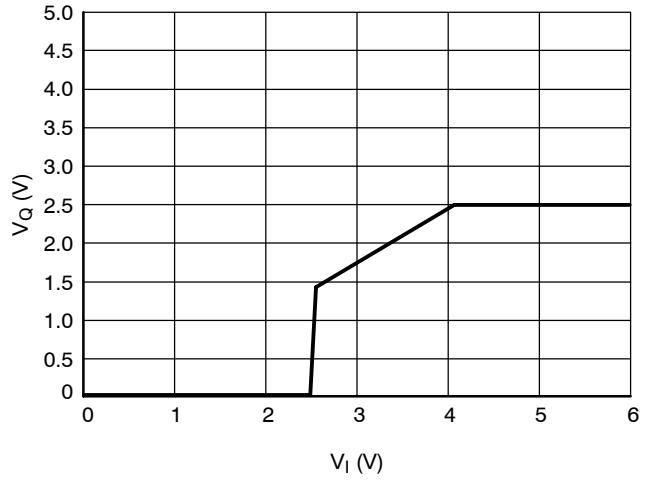

Figure 22. Output Voltage vs. Input Voltage

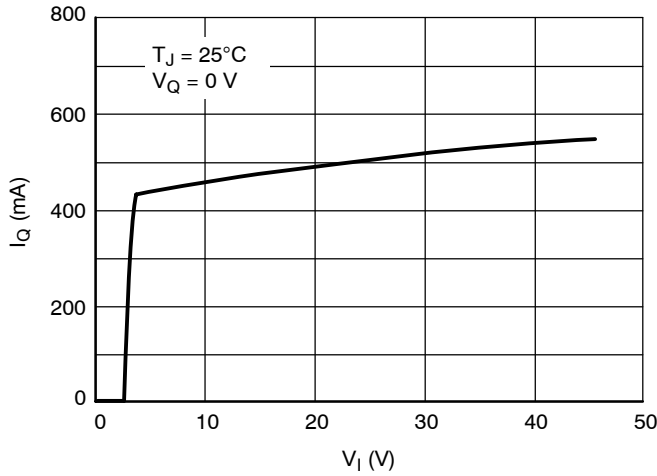

Figure 23. Output Current vs. Input Voltage

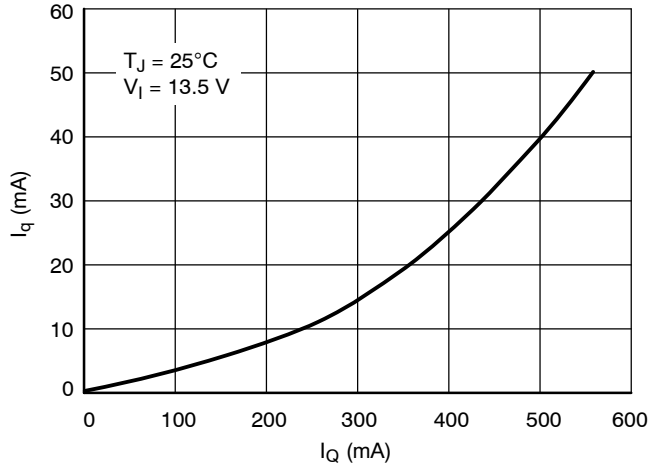

Figure 24. Current Consumption vs. Output Current (High Load)

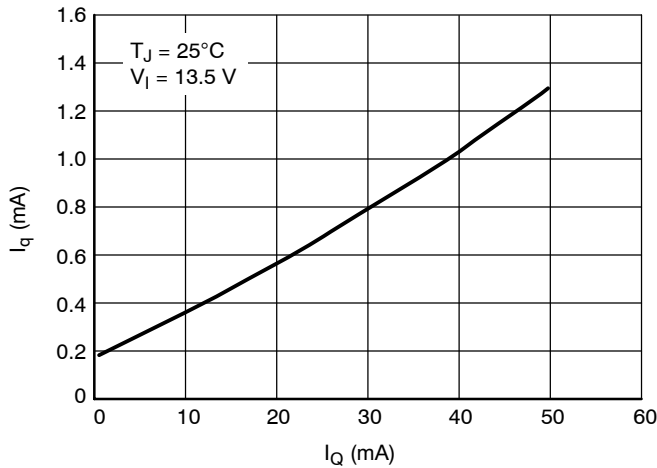

Figure 25. Current Consumption vs. Output Current (Low Load)

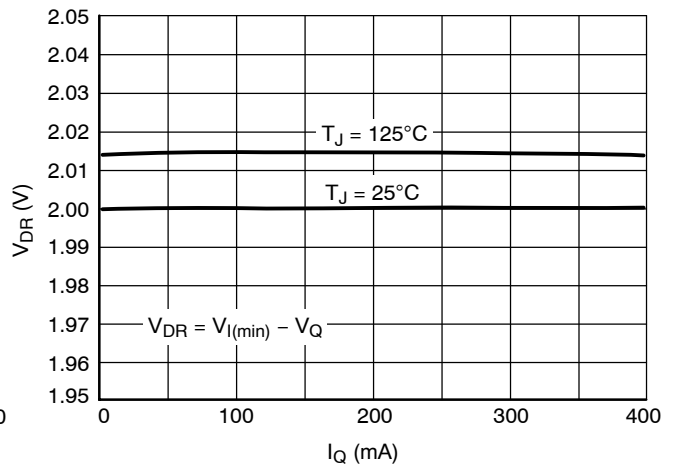

Figure 26. Voltage Drop vs. Output Current

NCV4274, NCV4274A

TYPICAL CHARACTERISTIC CURVES – 2.5 V Version

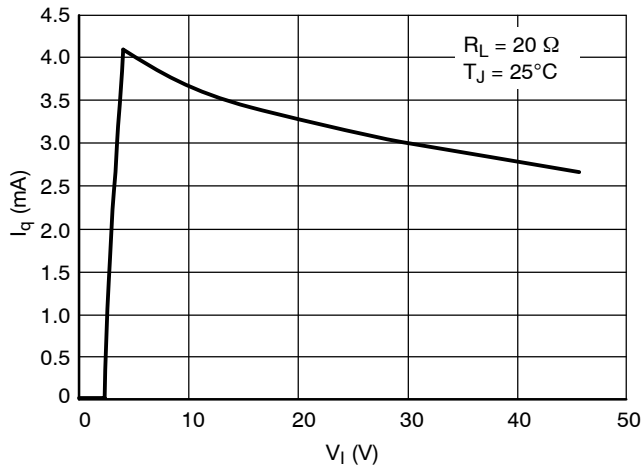

Figure 27. Current Consumption vs. Input Voltage

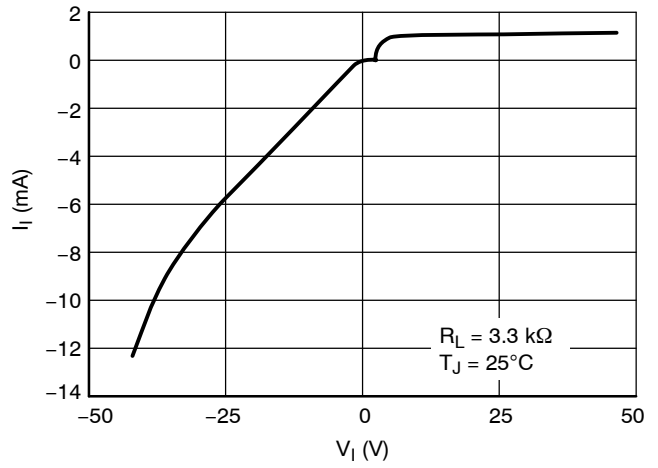

Figure 28. Input Current vs. Input Voltage

APPLICATION DESCRIPTION

Output Regulator

The output is controlled by a precision trimmed reference and error amplifier. The PNP output has saturation control for regulation while the input voltage is low, preventing over saturation. Current limit and voltage monitors complement the regulator design to give safe operating signals to the processor and control circuits.

Stability Considerations

The input capacitor C_{I1} in Figure 2 is necessary for compensating input line reactance. Possible oscillations caused by input inductance and input capacitance can be damped by using a resistor of approximately 1 Ω in series with C_{I2}.

The output or compensation capacitor helps determine three main characteristics of a linear regulator: startup delay, load transient response and loop stability.

The capacitor value and type should be based on cost, availability, size and temperature constraints. The aluminum electrolytic capacitor is the least expensive solution, but, if the circuit operates at low temperatures (–25°C to –40°C), both the value and ESR of the capacitor will vary considerably. The capacitor manufacturer’s data sheet usually provides this information.

The value for the output capacitor C_Q shown in Figure 2 should work for most applications; however, it is not necessarily the optimized solution. Stability is guaranteed at values C_Q ≥ 2.2 μF and an ESR ≤ 2.5 Ω within the operating temperature range. Actual limits are shown in a graph in the Typical Performance Characteristics section.

Calculating Power Dissipation in a Single Output Linear Regulator

The maximum power dissipation for a single output regulator (Figure 3) is:

$$P_{D(max)} = [V_{I(max)} - V_{Q(min)}]I_{Q(max)} + V_{I(max)}I_q \quad (eq. 1)$$

Where:

- V_{I(max)} is the maximum input voltage,
- V_{Q(min)} is the minimum output voltage,
- I_{Q(max)} is the maximum output current for the application, and
- I_q is the quiescent current the regulator consumes at I_{Q(max)}.

Once the value of P_{D(max)} is known, the maximum permissible value of R_{θJA} can be calculated:

$$P_{\theta JA} = \frac{(150 C - T_A)}{P_D} \quad (eq. 2)$$

The value of R_{θJA} can then be compared with those in the package section of the data sheet. Those packages with R_{θJA}’s less than the calculated value in Equation 2 will keep the die temperature below 150°C. In some cases, none of the packages will be sufficient to dissipate the heat generated by the IC, and an external heat sink will be required. The current flow and voltages are shown in the Measurement Circuit Diagram.

Heat Sinks

A heat sink effectively increases the surface area of the package to improve the flow of heat away from the IC and into the surrounding air.

Each material in the heat flow path between the IC and the outside environment will have a thermal resistance. Like series electrical resistances, these resistances are summed to determine the value of R_{θJA}:

$$R_{\theta JA} = R_{\theta JC} + R_{\theta CS} + R_{\theta SA} \quad (eq. 3)$$

Where:

- R_{θJC} = the junction-to-case thermal resistance,
 - R_{θCS} = the case-to-heat sink thermal resistance, and
 - R_{θSA} = the heat sink-to-ambient thermal resistance.
- R_{θJC} appears in the package section of the data sheet.

Like R_{θJA}, it too is a function of package type. R_{θCS} and R_{θSA} are functions of the package type, heat sink and the interface between them. These values appear in data sheets of heat sink manufacturers. Thermal, mounting, and heat sinking are discussed in the ON Semiconductor application note AN1040/D, available on the ON Semiconductor Website.

NCV4274, NCV4274A

ORDERING INFORMATION4

Device	Output Voltage Accuracy	Output Voltage	Package	Shipping†
NCV4274DS50G	4%	5.0 V	D2PAK (Pb-Free)	50 Units / Rail
NCV4274DS50R4G	4%	5.0 V	D2PAK (Pb-Free)	800 / Tape & Reel
NCV4274DT50G	4%	5.0 V	DPAK (Pb-Free)	75 Units / Rail
NCV4274DT50RKG	4%	5.0 V	DPAK (Pb-Free)	2500 / Tape & Reel
NCV4274ADS50G	2%	5.0 V	D2PAK (Pb-Free)	50 Units / Rail
NCV4274ADS50R4G	2%	5.0 V	D2PAK (Pb-Free)	800 / Tape & Reel
NCV4274ADT50G	2%	5.0 V	DPAK (Pb-Free)	75 Units / Rail
NCV4274ADT50RKG	2%	5.0 V	DPAK (Pb-Free)	2500 / Tape & Reel
NCV4274ST33T3G	4%	3.3 V	SOT-223 (Pb-Free)	4000 / Tape & Reel
NCV4274DT33RKG	4%	3.3 V	DPAK (Pb-Free)	2500 / Tape & Reel
NCV4274AST33T3G	2%	3.3 V	SOT-223 (Pb-Free)	4000 / Tape & Reel
NCV4274ADT33RKG	2%	3.3 V	DPAK (Pb-Free)	2500 / Tape & Reel
NCV4274ST25T3G	4%	2.5 V	SOT-223 (Pb-Free)	4000 / Tape & Reel
NCV4274AST25T3G	2%	2.5 V	SOT-223 (Pb-Free)	4000 / Tape & Reel

†For information on tape and reel specifications, including part orientation and tape sizes, please refer to our Tape and Reel Packaging Specifications Brochure, BRD8011/D.

NCV4274, NCV4274A

PACKAGE DIMENSIONS

DPAK (SINGLE GAUGE)
CASE 369C-01
ISSUE O

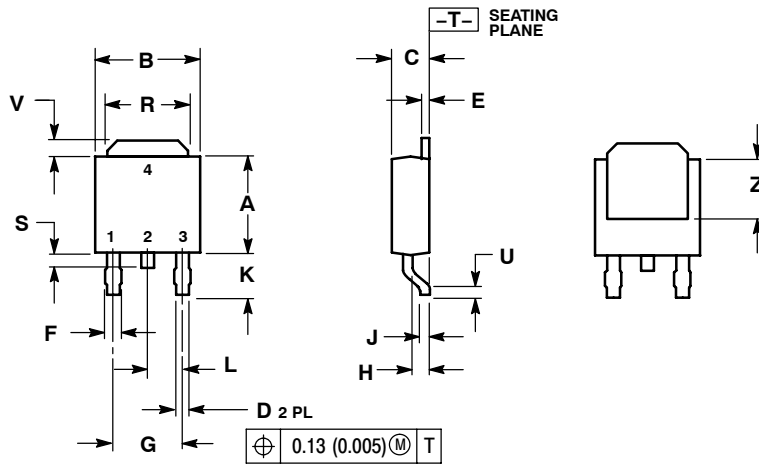

- NOTES:
1. DIMENSIONING AND TOLERANCING PER ANSI Y14.5M, 1982.
2. CONTROLLING DIMENSION: INCH.

DIM	INCHES		MILLIMETERS	
	MIN	MAX	MIN	MAX
A	0.235	0.245	5.97	6.22
B	0.250	0.265	6.35	6.73
C	0.086	0.094	2.19	2.38
D	0.027	0.035	0.69	0.88
E	0.018	0.023	0.46	0.58
F	0.037	0.045	0.94	1.14
G	0.180 BSC		4.58 BSC	
H	0.034	0.040	0.87	1.01
J	0.018	0.023	0.46	0.58
K	0.102	0.114	2.60	2.89
L	0.090 BSC		2.29 BSC	
R	0.180	0.215	4.57	5.45
S	0.025	0.040	0.63	1.01
U	0.020	---	0.51	---
V	0.035	0.050	0.89	1.27
Z	0.155	---	3.93	---

SOLDERING FOOTPRINT*

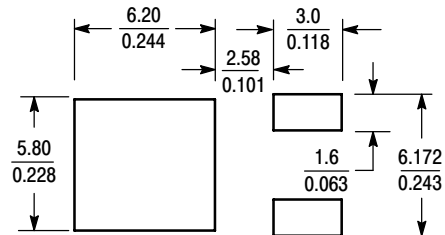

SCALE 3:1 $\left(\frac{\text{mm}}{\text{inches}}\right)$

*For additional information on our Pb-Free strategy and soldering details, please download the ON Semiconductor Soldering and Mounting Techniques Reference Manual, SOLDERRM/D.

NCV4274, NCV4274A

PACKAGE DIMENSIONS

SOT-223 (TO-261)
CASE 318E-04
ISSUE L

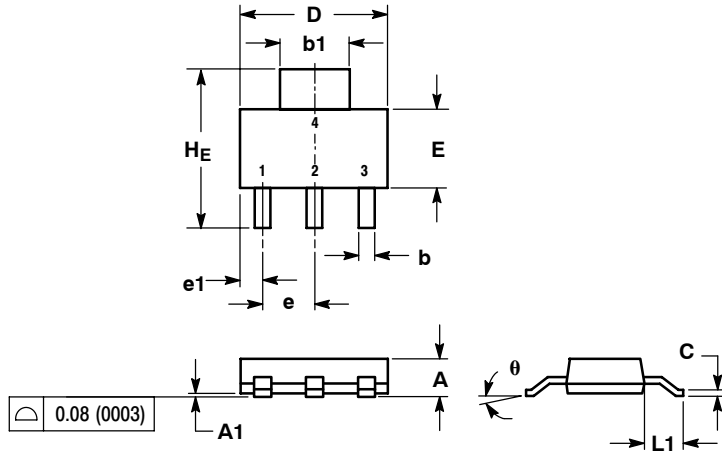

- NOTES:
1. DIMENSIONING AND TOLERANCING PER ANSI Y14.5M, 1982.
2. CONTROLLING DIMENSION: INCH.

DIM	MILLIMETERS			INCHES		
	MIN	NOM	MAX	MIN	NOM	MAX
A	1.50	1.63	1.75	0.060	0.064	0.068
A1	0.02	0.06	0.10	0.001	0.002	0.004
b	0.60	0.75	0.89	0.024	0.030	0.035
b1	2.90	3.06	3.20	0.115	0.121	0.126
c	0.24	0.29	0.35	0.009	0.012	0.014
D	6.30	6.50	6.70	0.249	0.256	0.263
E	3.30	3.50	3.70	0.130	0.138	0.145
e	2.20	2.30	2.40	0.087	0.091	0.094
e1	0.85	0.94	1.05	0.033	0.037	0.041
L1	1.50	1.75	2.00	0.060	0.069	0.078
HE	6.70	7.00	7.30	0.264	0.276	0.287
θ	0°	-	10°	0°	-	10°

SOLDERING FOOTPRINT

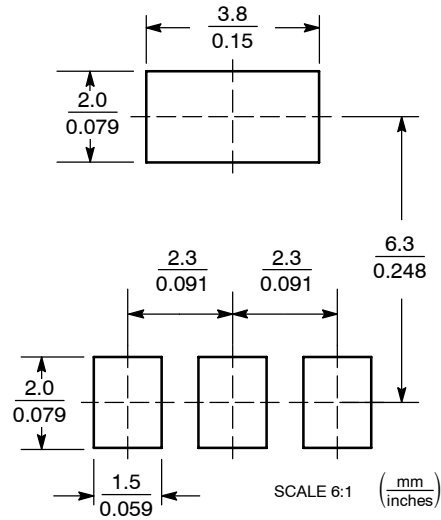

NCV4274, NCV4274A

PACKAGE DIMENSIONS

D2PAK CASE 936-03 ISSUE B

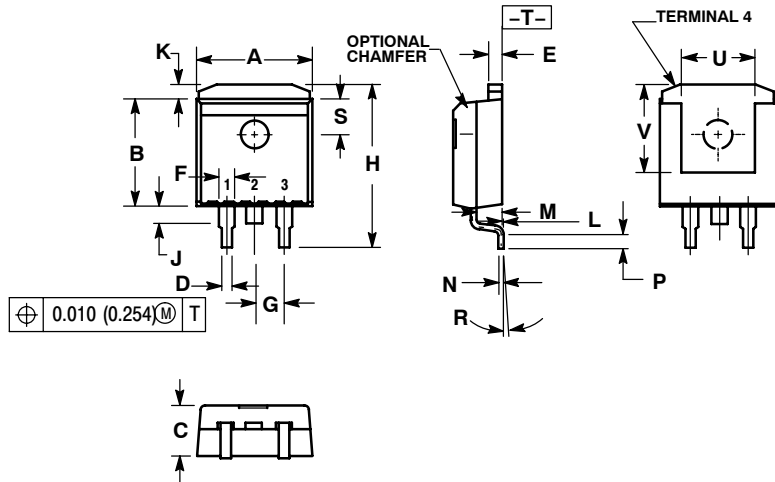

NOTES:

3. DIMENSIONING AND TOLERANCING PER ANSI Y14.5M, 1982.
4. CONTROLLING DIMENSION: INCH.
5. TAB CONTOUR OPTIONAL WITHIN DIMENSIONS A AND K.
6. DIMENSIONS U AND V ESTABLISH A MINIMUM MOUNTING SURFACE FOR TERMINAL 4.
7. DIMENSIONS A AND B DO NOT INCLUDE MOLD FLASH OR GATE PROTRUSIONS. MOLD FLASH AND GATE PROTRUSIONS NOT TO EXCEED 0.025 (0.635) MAXIMUM.

DIM	INCHES		MILLIMETERS	
	MIN	MAX	MIN	MAX
A	0.386	0.403	9.804	10.236
B	0.356	0.368	9.042	9.347
C	0.170	0.180	4.318	4.572
D	0.026	0.036	0.660	0.914
E	0.045	0.055	1.143	1.397
F	0.051 REF		1.295 REF	
G	0.100 BSC		2.540 BSC	
H	0.539	0.579	13.691	14.707
J	0.125 MAX		3.175 MAX	
K	0.050 REF		1.270 REF	
L	0.000	0.010	0.000	0.254
M	0.088	0.102	2.235	2.591
N	0.018	0.026	0.457	0.660
P	0.058	0.078	1.473	1.981
R	5° REF		5° REF	
S	0.116 REF		2.946 REF	
U	0.200 MIN		5.080 MIN	
V	0.250 MIN		6.350 MIN	

SOLDERING FOOTPRINT*

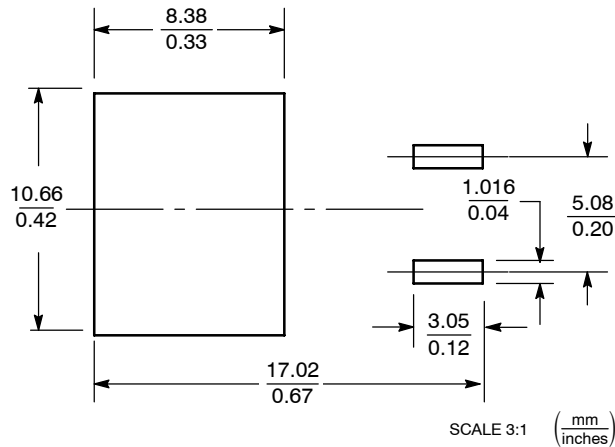

SCALE 3:1 (mm/inches)

*For additional information on our Pb-Free strategy and soldering details, please download the ON Semiconductor Soldering and Mounting Techniques Reference Manual, SOLDERRM/D.

ON Semiconductor and are registered trademarks of Semiconductor Components Industries, LLC (SCILLC). SCILLC reserves the right to make changes without further notice to any products herein. SCILLC makes no warranty, representation or guarantee regarding the suitability of its products for any particular purpose, nor does SCILLC assume any liability arising out of the application or use of any product or circuit, and specifically disclaims any and all liability, including without limitation special, consequential or incidental damages. "Typical" parameters which may be provided in SCILLC data sheets and/or specifications can and do vary in different applications and actual performance may vary over time. All operating parameters, including "Typicals" must be validated for each customer application by customer's technical experts. SCILLC does not convey any license under its patent rights nor the rights of others. SCILLC products are not designed, intended, or authorized for use as components in systems intended for surgical implant into the body, or other applications intended to support or sustain life, or for any other application in which the failure of the SCILLC product could create a situation where personal injury or death may occur. Should Buyer purchase or use SCILLC products for any such unintended or unauthorized application, Buyer shall indemnify and hold SCILLC and its officers, employees, subsidiaries, affiliates, and distributors harmless against all claims, costs, damages, and expenses, and reasonable attorney fees arising out of, directly or indirectly, any claim of personal injury or death associated with such unintended or unauthorized use, even if such claim alleges that SCILLC was negligent regarding the design or manufacture of the part. SCILLC is an Equal Opportunity/Affirmative Action Employer. This literature is subject to all applicable copyright laws and is not for resale in any manner.

PUBLICATION ORDERING INFORMATION

LITERATURE FULFILLMENT:
Literature Distribution Center for ON Semiconductor
P.O. Box 5163, Denver, Colorado 80217 USA
Phone: 303-675-2175 or 800-344-3860 Toll Free USA/Canada
Fax: 303-675-2176 or 800-344-3867 Toll Free USA/Canada
Email: orderlit@onsemi.com

N. American Technical Support: 800-282-9855 Toll Free USA/Canada
Europe, Middle East and Africa Technical Support:
Phone: 421 33 790 2910
Japan Customer Focus Center
Phone: 81-3-5773-3850

ON Semiconductor Website: www.onsemi.com
Order Literature: <http://www.onsemi.com/orderlit>

For additional information, please contact your local Sales Representative