

NDP6050 / NDB6050 N-Channel Enhancement Mode Field Effect Transistor

General Description

These N-Channel enhancement mode power field effect transistors are produced using Fairchild's proprietary, high cell density, DMOS technology. This very high density process has been especially tailored to minimize on-state resistance, provide superior switching performance, and withstand high energy pulses in the avalanche and commutation modes. These devices are particularly suited for low voltage applications such as automotive, DC/DC converters, PWM motor controls, and other battery powered circuits where fast switching, low in-line power loss, and resistance to transients are needed.

Features

- 48A, 50V. $R_{DS(ON)} = 0.025\Omega @ V_{GS}=10V$.
- Critical DC electrical parameters specified at elevated temperature.
- Rugged internal source-drain diode can eliminate the need for an external Zener diode transient suppressor.
- 175°C maximum junction temperature rating.
- High density cell design for extremely low $R_{DS(ON)}$.
- TO-220 and TO-263 (D²PAK) package for both through hole and surface mount applications.

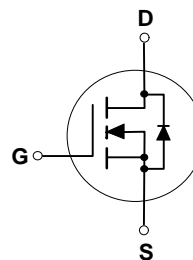
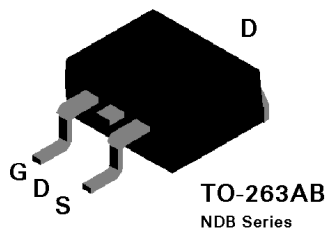
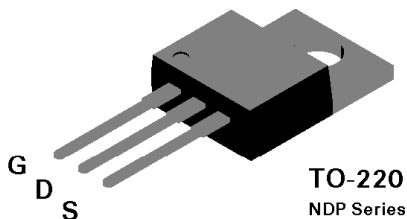

Absolute Maximum Ratings $T_C = 25^\circ\text{C}$ unless otherwise noted

| Symbol | Parameter | NDP6050 | NDB6050 | Units |
|----------------|---|------------|---------|---------------------|
| V_{DSS} | Drain-Source Voltage | 50 | | V |
| V_{DGR} | Drain-Gate Voltage ($R_{GS} \leq 1\text{ M}\Omega$) | 50 | | V |
| V_{GSS} | Gate-Source Voltage - Continuous - Nonrepetitive ($t_p < 50\ \mu\text{s}$) | ± 20 | | V |
| | | ± 40 | | |
| I_D | Drain Current - Continuous - Pulsed | 48 | | A |
| | | 144 | | |
| P_D | Total Power Dissipation @ $T_C = 25^\circ\text{C}$ Derate above 25°C | 100 | | W |
| | | 0.67 | | W/ $^\circ\text{C}$ |
| T_J, T_{STG} | Operating and Storage Temperature Range | -65 to 175 | | $^\circ\text{C}$ |
| T_L | Maximum lead temperature for soldering purposes, 1/8" from case for 5 seconds | 275 | | $^\circ\text{C}$ |

Electrical Characteristics ($T_c = 25^\circ\text{C}$ unless otherwise noted)

| Symbol | Parameter | Conditions | Min | Typ | Max | Units |
|--|--|---|---------------------------|------|-------|---------------|
| DRAIN-SOURCE AVALANCHE RATINGS (Note 1) | | | | | | |
| W_{DSS} | Single Pulse Drain-Source Avalanche Energy | $V_{DD} = 25\text{ V}, I_D = 48\text{ A}$ | | | 200 | mJ |
| I_{AR} | Maximum Drain-Source Avalanche Current | | | | 48 | A |
| OFF CHARACTERISTICS | | | | | | |
| BV_{DSS} | Drain-Source Breakdown Voltage | $V_{GS} = 0\text{ V}, I_D = 250\ \mu\text{A}$ | 50 | | | V |
| I_{DSS} | Zero Gate Voltage Drain Current | $V_{DS} = 50\text{ V}, V_{GS} = 0\text{ V}$ | | | 250 | μA |
| | | | $T_J = 125^\circ\text{C}$ | | 1 | mA |
| I_{GSSF} | Gate - Body Leakage, Forward | $V_{GS} = 20\text{ V}, V_{DS} = 0\text{ V}$ | | | 100 | nA |
| I_{GSSR} | Gate - Body Leakage, Reverse | $V_{GS} = -20\text{ V}, V_{DS} = 0\text{ V}$ | | | -100 | nA |
| ON CHARACTERISTICS (Note 1) | | | | | | |
| $V_{GS(th)}$ | Gate Threshold Voltage | $V_{DS} = V_{GS}, I_D = 250\ \mu\text{A}$ | 2 | 2.9 | 4 | V |
| | | | $T_J = 125^\circ\text{C}$ | 1.4 | 2.3 | |
| $R_{DS(on)}$ | Static Drain-Source On-Resistance | $V_{GS} = 10\text{ V}, I_D = 24\text{ A}$ | | 0.02 | 0.025 | Ω |
| | | | $T_J = 125^\circ\text{C}$ | | 0.032 | |
| $I_{D(on)}$ | On-State Drain Current | $V_{GS} = 10\text{ V}, V_{DS} = 10\text{ V}$ | 48 | | | A |
| g_{FS} | Forward Transconductance | $V_{DS} = 10\text{ V}, I_D = 24\text{ A}$ | 10 | 19 | | S |
| DYNAMIC CHARACTERISTICS | | | | | | |
| C_{iss} | Input Capacitance | $V_{DS} = 25\text{ V}, V_{GS} = 0\text{ V},$ $f = 1.0\text{ MHz}$ | | 1190 | 1800 | pF |
| C_{oss} | Output Capacitance | | | 475 | 800 | |
| C_{rss} | Reverse Transfer Capacitance | | | 150 | 400 | |
| SWITCHING CHARACTERISTICS (Note 1) | | | | | | |
| $t_{D(on)}$ | Turn - On Delay Time | $V_{DD} = 30\text{ V}, I_D = 48\text{ A},$ $V_{GS} = 10\text{ V}, R_{GEN} = 7.5\ \Omega$ | | 10 | 20 | nS |
| t_r | Turn - On Rise Time | | | 145 | 300 | |
| $t_{D(off)}$ | Turn - Off Delay Time | | | 28 | 60 | |
| t_f | Turn - Off Fall Time | | | 77 | 150 | |
| Q_g | Total Gate Charge | $V_{DS} = 48\text{ V},$ $I_D = 48\text{ A}, V_{GS} = 10\text{ V}$ | | 39 | 70 | nC |
| Q_{gs} | Gate-Source Charge | | | 7.6 | | |
| Q_{gd} | Gate-Drain Charge | | | 22 | | |

Electrical Characteristics ($T_c = 25^\circ\text{C}$ unless otherwise noted)

| Symbol | Parameter | Conditions | Min | Typ | Max | Units |
|---|---|---|---------------------------|-----|------|---------------------------|
| DRAIN-SOURCE DIODE CHARACTERISTICS | | | | | | |
| I_S | Maximum Continuous Drain-Source Diode Forward Current | | | | 48 | A |
| I_{SM} | Maximum Pulsed Drain-Source Diode Forward Current | | | | 144 | A |
| V_{SD} | Drain-Source Diode Forward Voltage | $V_{GS} = 0\text{ V}$, $I_S = 24\text{ A}$ (Note 1) | | 0.9 | 1.3 | V |
| | | | $T_J = 125^\circ\text{C}$ | 0.8 | 1.2 | |
| t_{TR} | Reverse Recovery Time | $V_{GS} = 0\text{ V}$, $I_F = 48\text{ A}$, $di_F/dt = 100\text{ A}/\mu\text{s}$ | 35 | 87 | 140 | ns |
| I_{TR} | Reverse Recovery Current | | 2 | 3.6 | 8 | A |
| THERMAL CHARACTERISTICS | | | | | | |
| $R_{\theta JC}$ | Thermal Resistance, Junction-to-Case | | | | 1.5 | $^\circ\text{C}/\text{W}$ |
| $R_{\theta JA}$ | Thermal Resistance, Junction-to-Ambient | | | | 62.5 | $^\circ\text{C}/\text{W}$ |

Note:

1. Pulse Test: Pulse Width $\leq 300\ \mu\text{s}$, Duty Cycle $\leq 2.0\%$.

Typical Electrical Characteristics

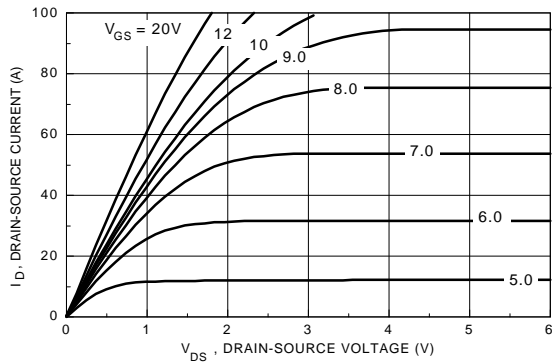

Figure 1. On-Region Characteristics

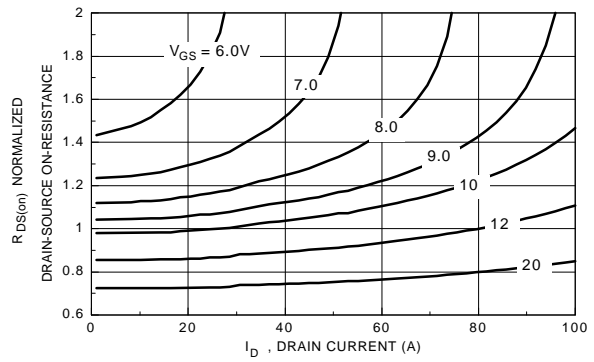

Figure 2. On-Resistance Variation with Gate Voltage and Drain Current

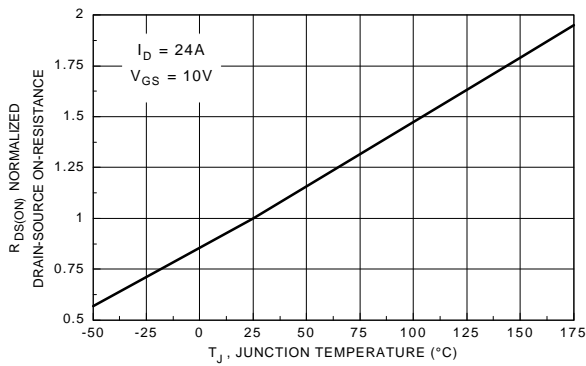

Figure 3. On-Resistance Variation with Temperature

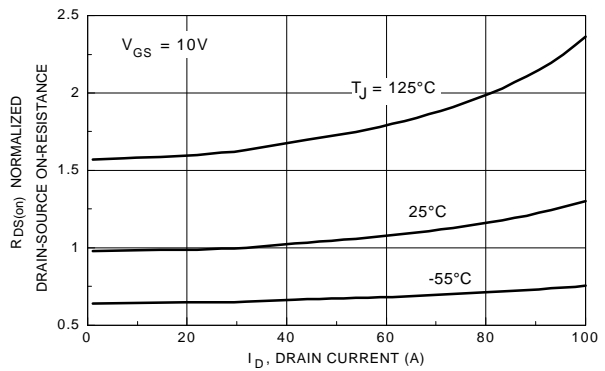

Figure 4. On-Resistance Variation with Drain Current and Temperature

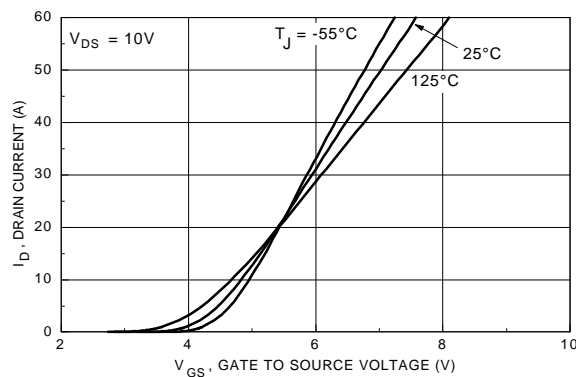

Figure 5. Transfer Characteristics

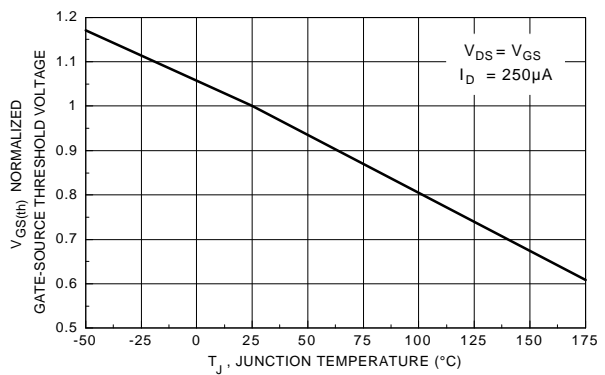

Figure 6. Gate Threshold Variation with Temperature

Typical Electrical Characteristics (continued)

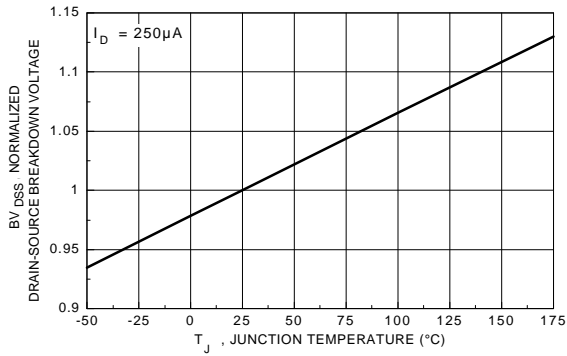

Figure 7. Breakdown Voltage Variation with Temperature

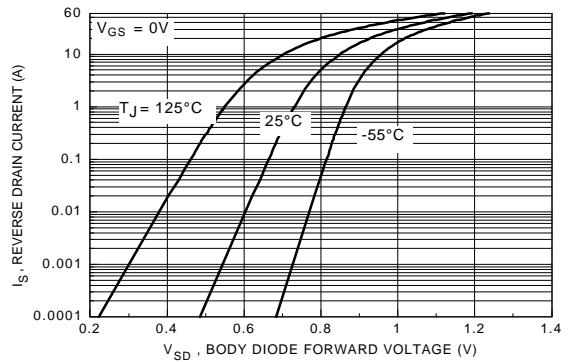

Figure 8. Body Diode Forward Voltage Variation with Current and Temperature

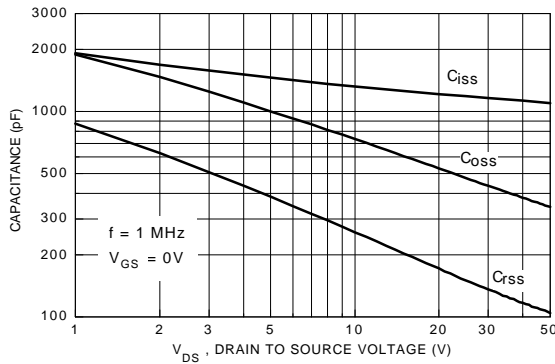

Figure 9. Capacitance Characteristics

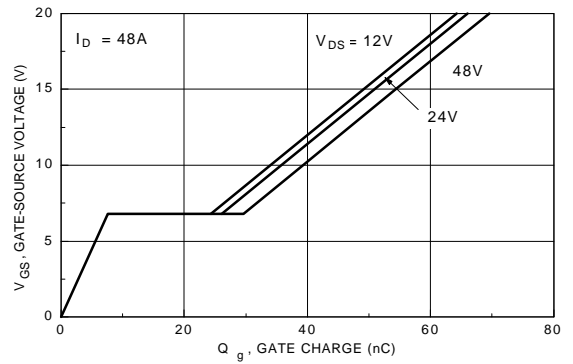

Figure 10. Gate Charge Characteristics

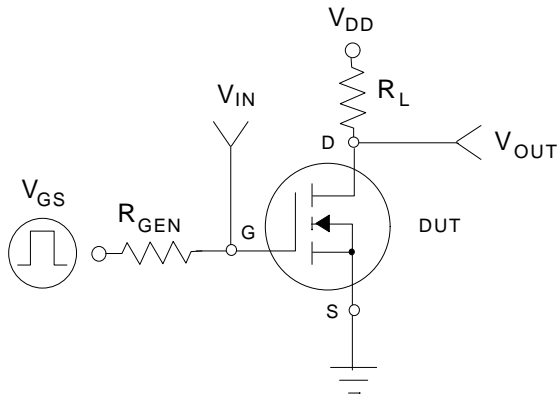

Figure 11. Switching Test Circuit

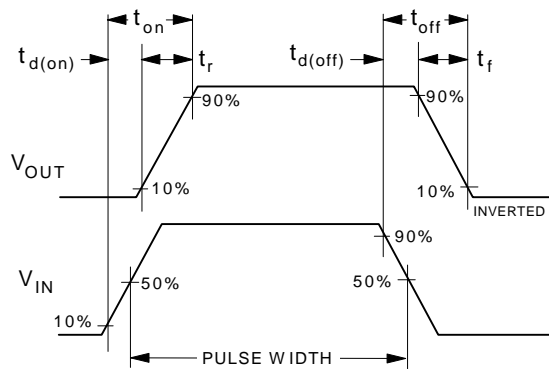

Figure 12. Switching Waveforms

Typical Electrical Characteristics (continued)

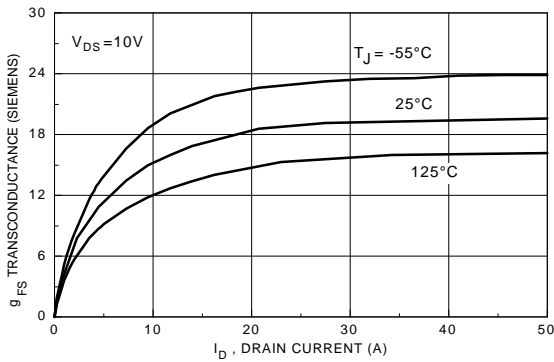

Figure 13. Transconductance Variation with Drain Current and Temperature

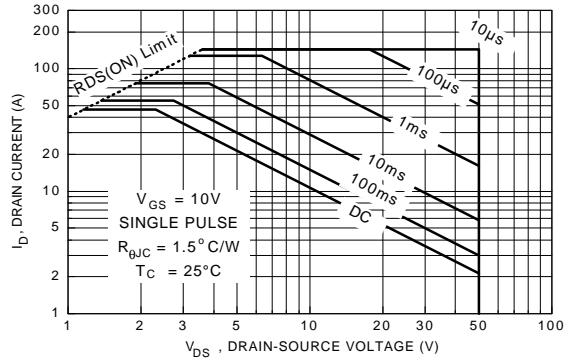

Figure 14. Maximum Safe Operating Area

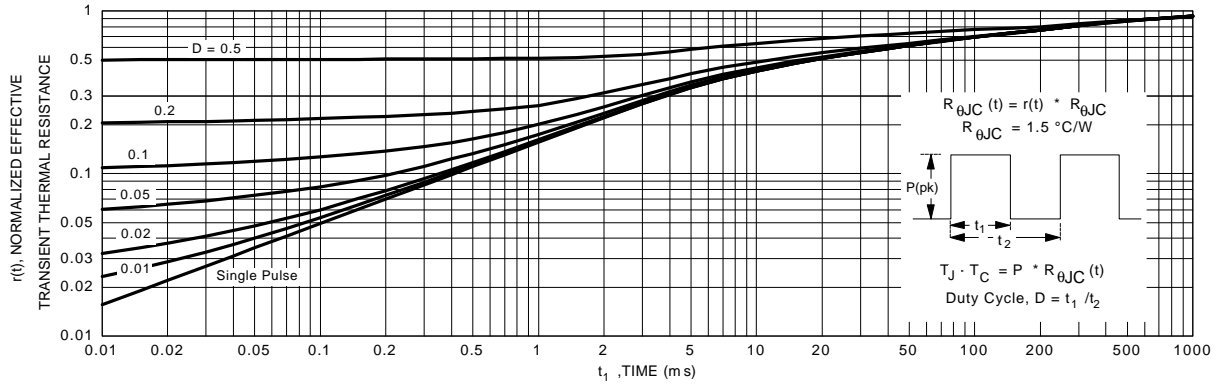

Figure 15. Transient Thermal Response Curve