

## NZT660 / NZT660A

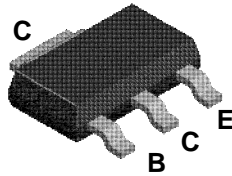

SOT-223

### PNP Low Saturation Transistor

These devices are designed with high current gain and low saturation voltage with collector currents up to 3A continuous.

#### Absolute Maximum Ratings\*

$T_A = 25^\circ\text{C}$  unless otherwise noted

Symbol	Parameter	NZT660/NZT660A	Units
$V_{CEO}$	Collector-Emitter Voltage	60	V
$V_{CBO}$	Collector-Base Voltage	80	V
$V_{EBO}$	Emitter-Base Voltage	5	V
$I_C$	Collector Current - Continuous	3	A
$T_J, T_{stg}$	Operating and Storage Junction Temperature Range	-55 to +150	$^\circ\text{C}$

\*These ratings are limiting values above which the serviceability of any semiconductor device may be impaired.

#### NOTES:

- 1) These ratings are based on a maximum junction temperature of  $150^\circ\text{C}$ .
- 2) These are steady state limits. The factory should be consulted on applications involving pulsed or low duty cycle operations.

#### Thermal Characteristics

$T_A = 25^\circ\text{C}$  unless otherwise noted

Symbol	Characteristic	Max	Units
		NZT660/NZT660A	
$P_D$	Total Device Dissipation	2	W
$R_{\theta JA}$	Thermal Resistance, Junction to Ambient	62.5	$^\circ\text{C}/\text{W}$

**PNP Low Saturation Transistor**

(continued)

**Electrical Characteristics**

$T_A = 25^\circ\text{C}$  unless otherwise noted

Symbol	Parameter	Test Conditions	Min	Max	Units
<b>OFF CHARACTERISTICS</b>					
$BV_{CEO}$	Collector-Emitter Breakdown Voltage	$I_C = 10 \text{ mA}$	60		V
$BV_{CBO}$	Collector-Base Breakdown Voltage	$I_C = 100 \mu\text{A}$	80		V
$BV_{EBO}$	Emitter-Base Breakdown Voltage	$I_E = 100 \mu\text{A}$	5		V
$I_{CBO}$	Collector Cutoff Current	$V_{CB} = 30 \text{ V}$ $V_{CB} = 30 \text{ V}, T_A = 100^\circ\text{C}$		100 10	nA uA
$I_{EBO}$	Emitter Cutoff Current	$V_{EB} = 4 \text{ V}$		100	nA
<b>ON CHARACTERISTICS*</b>					
$h_{FE}$	DC Current Gain	$I_C = 100 \text{ mA}, V_{CE} = 2 \text{ V}$ $I_C = 500 \text{ mA}, V_{CE} = 2 \text{ V}$ <b>Nzt660</b> <b>Nzt660A</b> $I_C = 1 \text{ A}, V_{CE} = 2 \text{ V}$ $I_C = 3 \text{ A}, V_{CE} = 2 \text{ V}$	70 100 250 80 25	300 550	-
$V_{CE(sat)}$	Collector-Emitter Saturation Voltage	$I_C = 1 \text{ A}, I_B = 100 \text{ mA}$ $I_C = 3 \text{ A}, I_B = 300 \text{ mA}$ <b>Nzt660</b> <b>Nzt660A</b>		300 550 500	mV
$V_{BE(sat)}$	Base-Emitter Saturation Voltage	$I_C = 1 \text{ A}, I_B = 100 \text{ mA}$		1.25	V
$V_{BE(on)}$	Base-Emitter On Voltage	$I_C = 1 \text{ A}, V_{CE} = 2 \text{ V}$		1	V
<b>SMALL SIGNAL CHARACTERISTICS</b>					
$C_{obo}$	Output Capacitance	$V_{CB} = 10 \text{ V}, I_E = 0, f = 1 \text{ MHz}$		45	pF
$f_T$	Transition Frequency	$I_C = 100 \text{ mA}, V_{CE} = 5 \text{ V}, f = 100 \text{ MHz}$	75		-

\*Pulse Test: Pulse Width  $\leq 300 \mu\text{s}$ , Duty Cycle  $\leq 2.0\%$

## Typical Characteristics

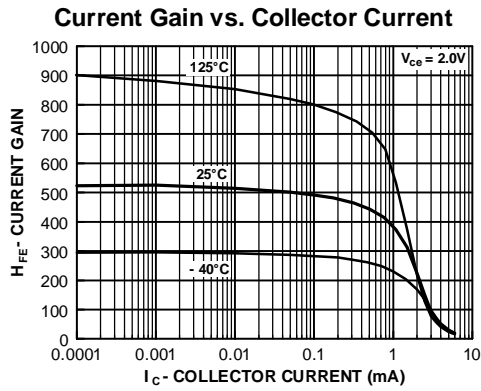
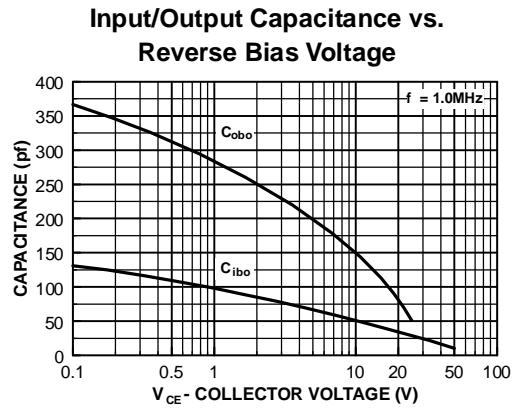
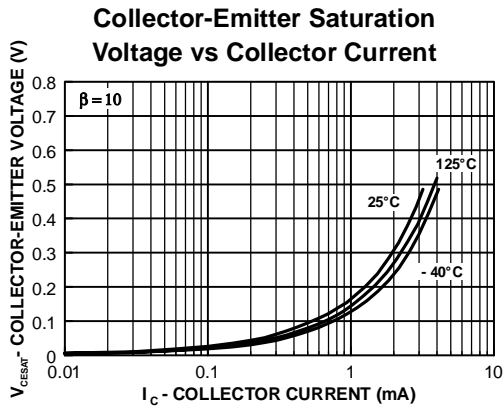
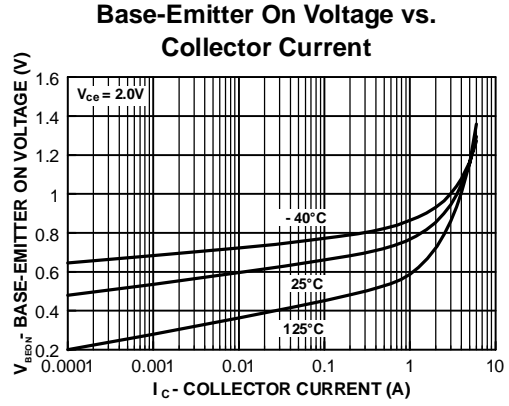
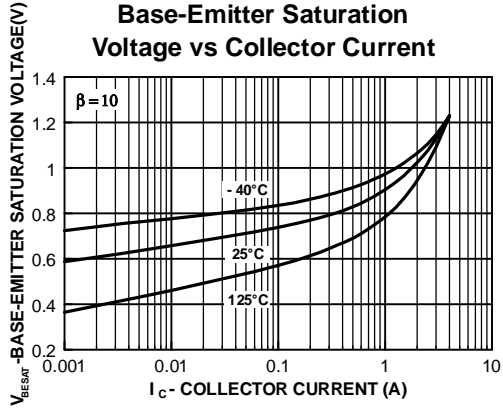

# SOT-223 Tape and Reel Data and Package Dimensions



## SOT-223 Packaging Configuration: Figure 1.0

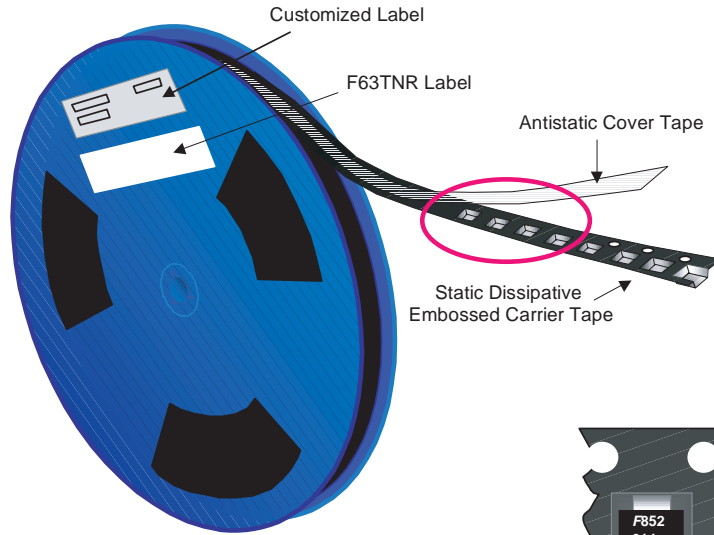

**Packaging Description:**  
 SOT-223 parts are shipped in tape. The carrier tape is made from a dissipative (carbon filled) polycarbonate resin. The cover tape is a multilayer film (Heat Activated Adhesive in nature) primarily composed of polyester film, adhesive layer, sealant, and anti-static sprayed agent. These reeled parts in standard option are shipped with 2,500 units per 13" or 330cm diameter reel. The reels are dark blue in color and is made of polystyrene plastic (anti-static coated). Other option comes in 500 units per 7" or 177cm diameter reel. This and some other options are further described in the Packaging Information table.  
 These full reels are individually barcode labeled and placed inside a standard intermediate box (illustrated in figure 1.0) made of recyclable corrugated brown paper. One box contains two reels maximum. And these boxes are placed inside a barcode labeled shipping box which comes in different sizes depending on the number of parts shipped.

SOT-223 Packaging Information		
Packaging Option	Standard (no flow code)	D84Z
Packaging type	TNR	TNR
Qty per Reel/Tube/Bag	2,500	500
Reel Size	13" Dia	7" Dia
Box Dimension (mm)	343x64x343	184x187x47
Max qty per Box	5,000	1,000
Weight per unit (gm)	0.1246	0.1246
Weight per Reel (kg)	0.7250	0.1532
Note/Comments		

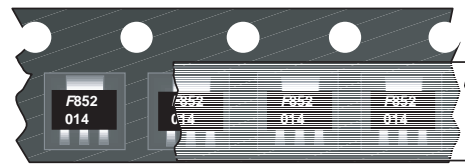

### SOT-223 Unit Orientation

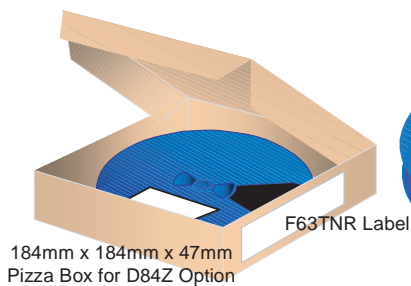
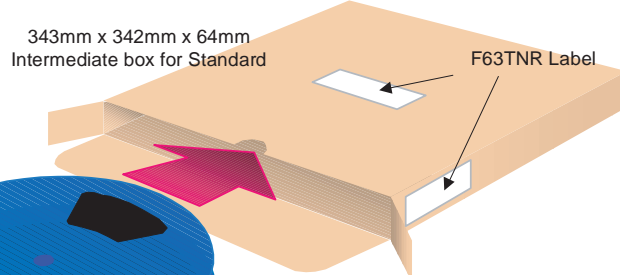

**F63TNR Label sample**

LOT: CBVK741B019	QTY: 3000
FSID: PN2222A	SPEC:
D/C1: D984Z	QTY1:
D/C2:	QTY2:
SPEC REV:	CPN:
	N/F: F
	(F63TNR)3

## SOT-223 Tape Leader and Trailer Configuration: Figure 2.0

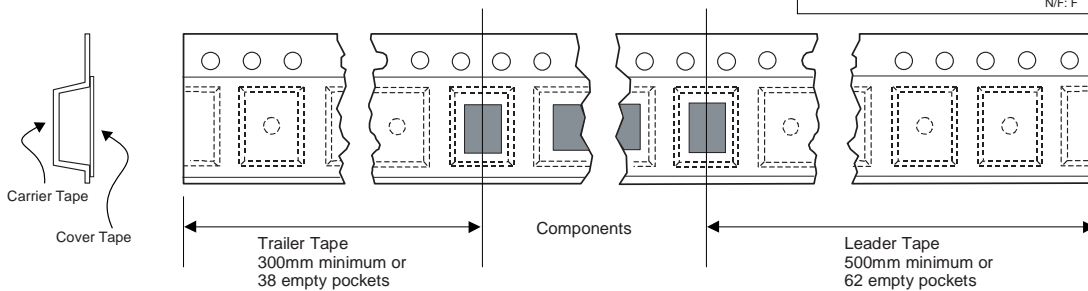

# SOT-223 Tape and Reel Data and Package Dimensions, continued

## SOT-223 Embossed Carrier Tape Configuration: Figure 3.0

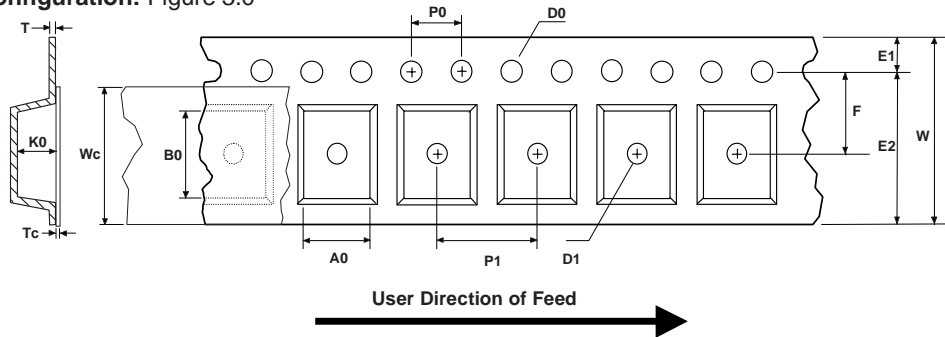

Dimensions are in millimeter														
Pkg type	A0	B0	W	D0	D1	E1	E2	F	P1	P0	K0	T	Wc	Tc
SOT-223 (12mm)	6.83 +/-0.10	7.42 +/-0.10	12.0 +/-0.3	1.55 +/-0.05	1.50 +/-0.10	1.75 +/-0.10	10.25 min	5.50 +/-0.05	8.0 +/-0.1	4.0 +/-0.1	1.88 +/-0.10	0.292 +/-0.0130	9.5 +/-0.025	0.06 +/-0.02

Notes: A0, B0, and K0 dimensions are determined with respect to the EIA/Jedec RS-481 rotational and lateral movement requirements (see sketches A, B, and C).

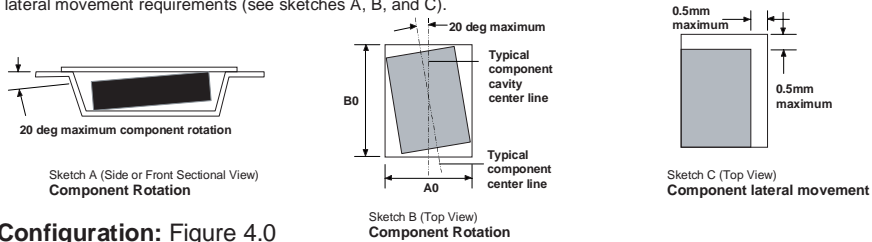

## SOT-223 Reel Configuration: Figure 4.0

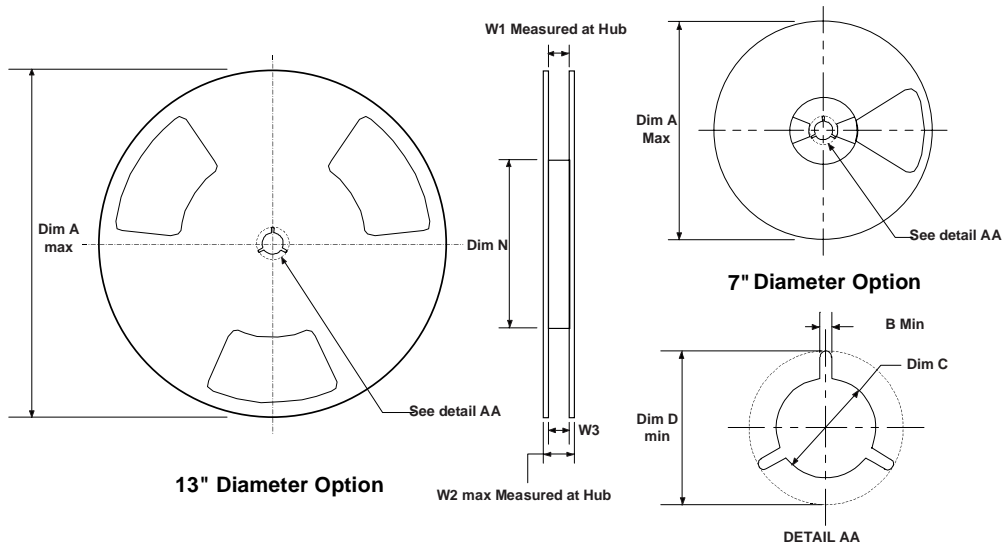

Dimensions are in inches and millimeters									
Tape Size	Reel Option	Dim A	Dim B	Dim C	Dim D	Dim N	Dim W1	Dim W2	Dim W3 (LSL-USL)
12mm	7" Dia	7.00 177.8	0.059 1.5	512 +0.020/-0.008 13 +0.5/-0.2	0.795 20.2	5.906 150	0.488 +0.078/-0.000 12.4 +2/0	0.724 18.4	0.469 - 0.606 11.9 - 15.4
12mm	13" Dia	13.00 330	0.059 1.5	512 +0.020/-0.008 13 +0.5/-0.2	0.795 20.2	7.00 178	0.488 +0.078/-0.000 12.4 +2/0	0.724 18.4	0.469 - 0.606 11.9 - 15.4

# SOT-223 Tape and Reel Data and Package Dimensions, continued

## SOT-223 (FS PKG Code 47)

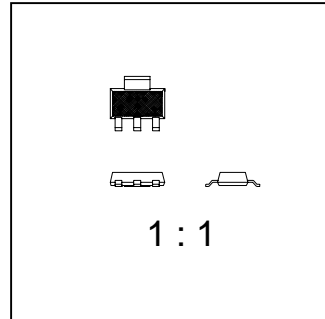
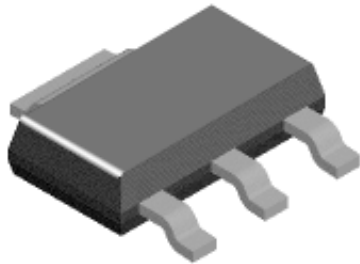

Scale 1:1 on letter size paper

Part Weight per unit (gram): 0.1246

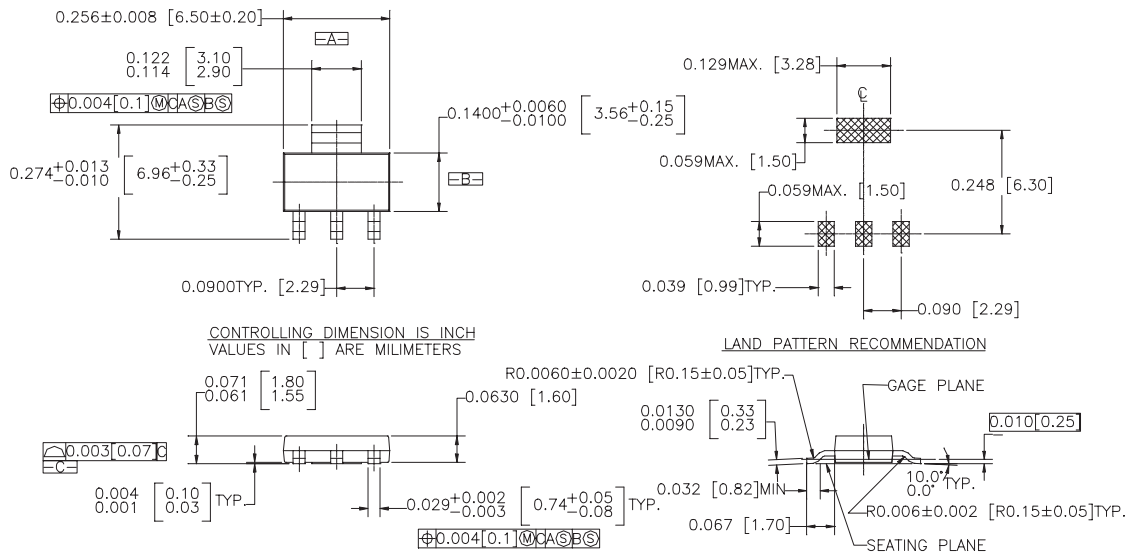

- NOTES : UNLESS OTHERWISE SPECIFIED
- STANDARD LEAD FINISH TO BE 150 MICRONS/ 3.81 MICROMETERS MINIMUM TIN/LEAD (SOLDER) ON COPPER.
  - REFERENCE JEDEC REGISTRATION TO-261, VARIATION AA, ISSUE A, DATED JAN 1990

SOT223, 4 LEADS

## TRADEMARKS

The following are registered and unregistered trademarks Fairchild Semiconductor owns or is authorized to use and is not intended to be an exhaustive list of all such trademarks.

ACEx™	ISOPLANAR™	UHC™
CoolFET™	MICROWIRE™	VCX™
CROSSVOLT™	POP™	
E <sup>2</sup> CMOS™	PowerTrench™	
FACT™	QST™	
FACT Quiet Series™	Quiet Series™	
FAST®	SuperSOT™-3	
FASTr™	SuperSOT™-6	
GTO™	SuperSOT™-8	
HiSeC™	TinyLogic™	

## DISCLAIMER

FAIRCHILD SEMICONDUCTOR RESERVES THE RIGHT TO MAKE CHANGES WITHOUT FURTHER NOTICE TO ANY PRODUCTS HEREIN TO IMPROVE RELIABILITY, FUNCTION OR DESIGN. FAIRCHILD DOES NOT ASSUME ANY LIABILITY ARISING OUT OF THE APPLICATION OR USE OF ANY PRODUCT OR CIRCUIT DESCRIBED HEREIN; NEITHER DOES IT CONVEY ANY LICENSE UNDER ITS PATENT RIGHTS, NOR THE RIGHTS OF OTHERS.

## LIFE SUPPORT POLICY

FAIRCHILD'S PRODUCTS ARE NOT AUTHORIZED FOR USE AS CRITICAL COMPONENTS IN LIFE SUPPORT DEVICES OR SYSTEMS WITHOUT THE EXPRESS WRITTEN APPROVAL OF FAIRCHILD SEMICONDUCTOR CORPORATION. As used herein:

1. Life support devices or systems are devices or systems which, (a) are intended for surgical implant into the body, or (b) support or sustain life, or (c) whose failure to perform when properly used in accordance with instructions for use provided in the labeling, can be reasonably expected to result in significant injury to the user.
2. A critical component is any component of a life support device or system whose failure to perform can be reasonably expected to cause the failure of the life support device or system, or to affect its safety or effectiveness.

## PRODUCT STATUS DEFINITIONS

### Definition of Terms

Datasheet Identification	Product Status	Definition
Advance Information	Formative or In Design	This datasheet contains the design specifications for product development. Specifications may change in any manner without notice.
Preliminary	First Production	This datasheet contains preliminary data, and supplementary data will be published at a later date. Fairchild Semiconductor reserves the right to make changes at any time without notice in order to improve design.
No Identification Needed	Full Production	This datasheet contains final specifications. Fairchild Semiconductor reserves the right to make changes at any time without notice in order to improve design.
Obsolete	Not In Production	This datasheet contains specifications on a product that has been discontinued by Fairchild semiconductor. The datasheet is printed for reference information only.