

NPN Silicon AF Power Transistors

- For AF drivers and output stages
- High collector current
- High current gain
- Low collector-emitter saturation voltage
- Complementary type: BDP952...BDP956 (PNP)

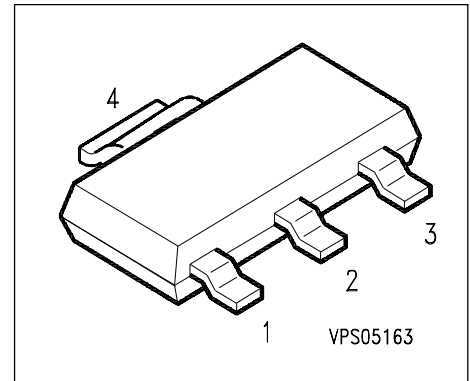

Type	Marking	Ordering Code	Pin Configuration				Package
			1 = B	2 = C	3 = E	4 = C	
BDP 951	BDP 951	Q62702-D1339	1 = B	2 = C	3 = E	4 = C	SOT-223
BDP 953	BDP 953	Q62702-D1341	1 = B	2 = C	3 = E	4 = C	SOT-223
BDP 955	PDP 955	Q62702-D1343	1 = B	2 = C	3 = E	4 = C	SOT-223

Maximum Ratings

Parameter	Symbol	Values	Unit
Collector-emitter voltage	V_{CEO}		V
BDP 951		80	
BDP 953		100	
BDP 955		120	
Collector-base voltage	V_{CBO}		
BDP 951		100	
BDP 953		120	
BDP 955		140	
Emitter-base voltage	V_{EBO}	5	
DC collector current	I_C	3	A
Peak collector current	I_{CM}	5	
Base current	I_B	200	mA
Peak base current	I_{BM}	500	
Total power dissipation, $T_S = 99^\circ\text{C}$	P_{tot}	3	W
Junction temperature	T_j	150	$^\circ\text{C}$
Storage temperature	T_{stg}	- 65 ... + 150	

Thermal Resistance

Junction ambient ¹⁾	R_{thJA}	≤ 42	K/W
Junction - soldering point	R_{thJS}	≤ 17	

1) Package mounted on pcb 40mm x 40mm x 1.5mm / 6cm² Cu

Electrical Characteristics at $T_A=25^\circ\text{C}$, unless otherwise specified

Parameter	Symbol	Values			Unit
		min.	typ.	max.	
DC Characteristics					
Collector-emitter breakdown voltage $I_C = 10 \text{ mA}$, $I_B = 0 \text{ mA}$, BDP 951 $I_C = 10 \text{ mA}$, $I_B = 0 \text{ mA}$, BDP 953 $I_C = 10 \text{ mA}$, $I_B = 0 \text{ mA}$, BDP 955	$V_{(BR)CEO}$	80 100 120	- - -	- - -	V
Collector-base breakdown voltage $I_C = 100 \mu\text{A}$, $I_B = 0$, BDP 951 $I_C = 100 \mu\text{A}$, $I_B = 0$, BDP 953 $I_C = 100 \mu\text{A}$, $I_B = 0$, BDP 955	$V_{(BR)CBO}$	100 120 140	- - -	- - -	
Base-emitter breakdown voltage $I_E = 10 \mu\text{A}$, $I_C = 0$	$V_{(BR)EBO}$	5	-	-	
Collector cutoff current $V_{CB} = 100 \text{ V}$, $I_E = 0$, $T_A = 25^\circ\text{C}$ $V_{CB} = 100 \text{ V}$, $I_E = 0$, $T_A = 150^\circ\text{C}$	I_{CBO}	- -	- -	100 20	nA μA
Emitter cutoff current $V_{EB} = 4 \text{ V}$, $I_C = 0$	I_{EBO}	-	-	100	nA
DC current gain $I_C = 10 \text{ mA}$, $V_{CE} = 5 \text{ V}$ $I_C = 500 \text{ mA}$, $V_{CE} = 1 \text{ V}$ $I_C = 2 \text{ A}$, $V_{CE} = 2 \text{ V}$	h_{FE}	25 40 15	- - -	- 475 -	-
Collector-emitter saturation voltage 1) $I_C = 2 \text{ A}$, $I_B = 0.2 \text{ A}$	V_{CEsat}	-	-	0.8	V
Base-emitter saturation voltage 1) $I_C = 2 \text{ A}$, $I_B = 0.2 \text{ A}$	V_{BEsat}	-	-	1.5	
AC Characteristics					
Transition frequency $I_C = 50 \text{ mA}$, $V_{CE} = 10 \text{ V}$, $f = 100 \text{ MHz}$	f_T	-	100	-	MHz
Collector-base capacitance $V_{CB} = 10 \text{ V}$, $f = 1 \text{ MHz}$	C_{cb}	-	25	-	pF

1) Pulse test: $t < 300\mu\text{s}$; $D < 2\%$

Total power dissipation $P_{tot} = f(T_A^*; T_S)$

* Package mounted on epoxy

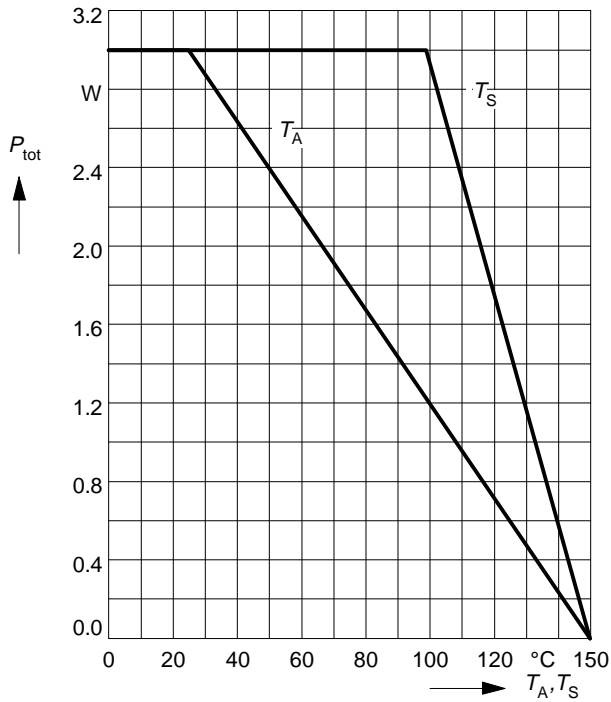

Permissible Pulse Load $R_{thJS} = f(t_p)$

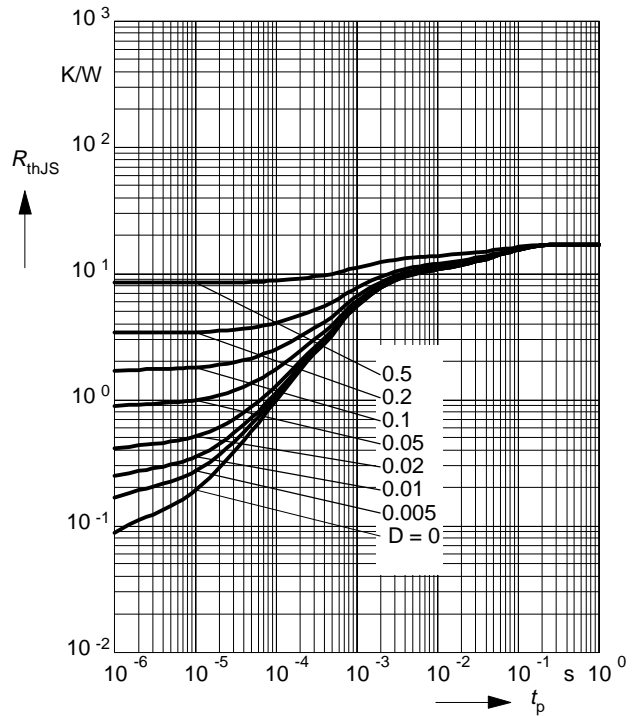

Permissible Pulse Load $P_{totmax} / P_{totDC} = f(t_p)$ DC current gain $h_{FE} = f(I_C)$

$V_{CE} = 2V$

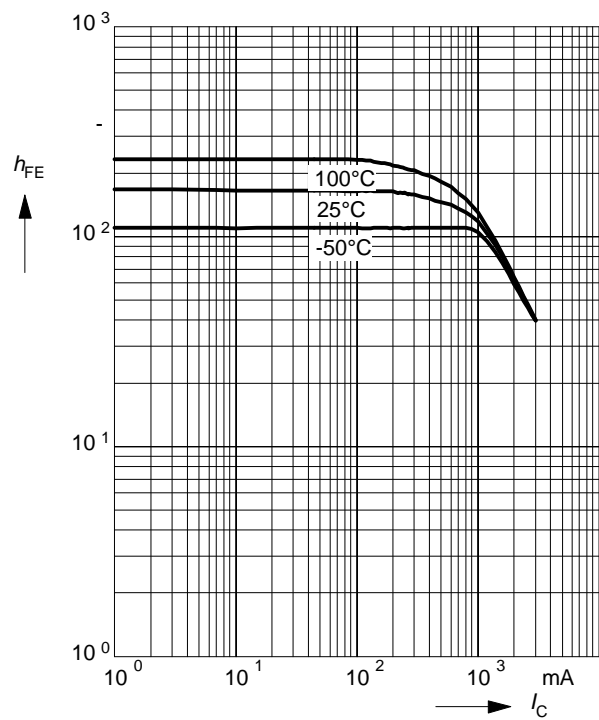
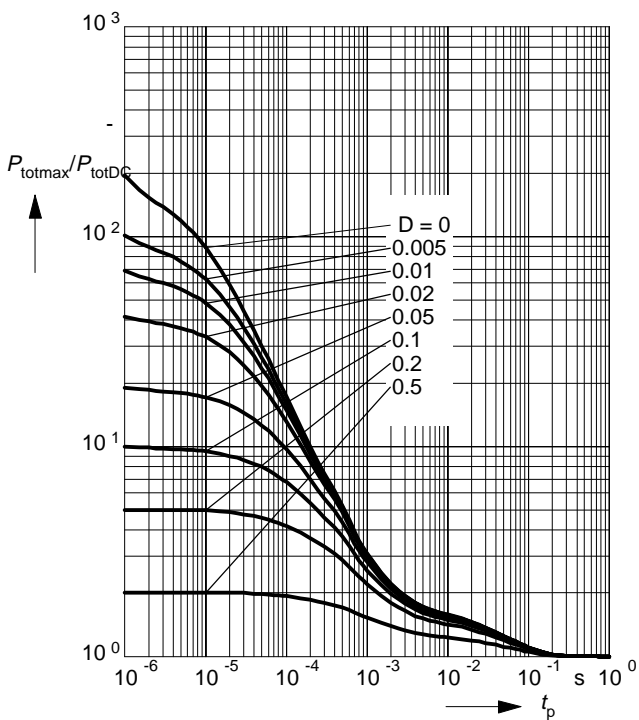

Collector cutoff current $I_{CBO} = f(T_A)$

$V_{CB} = 45V$

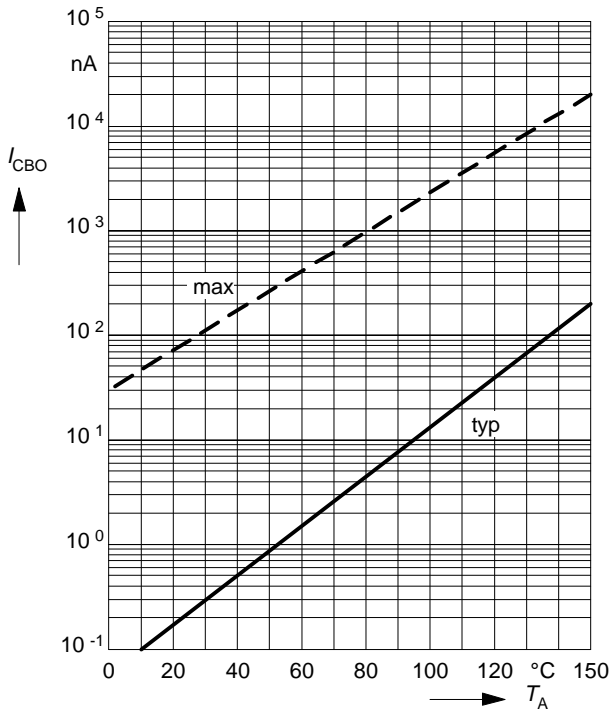

Collector-emitter saturation voltage $I_C = f(V_{CEsat}), h_{FE} = 10$

$I_C = f(V_{CEsat}), h_{FE} = 10$

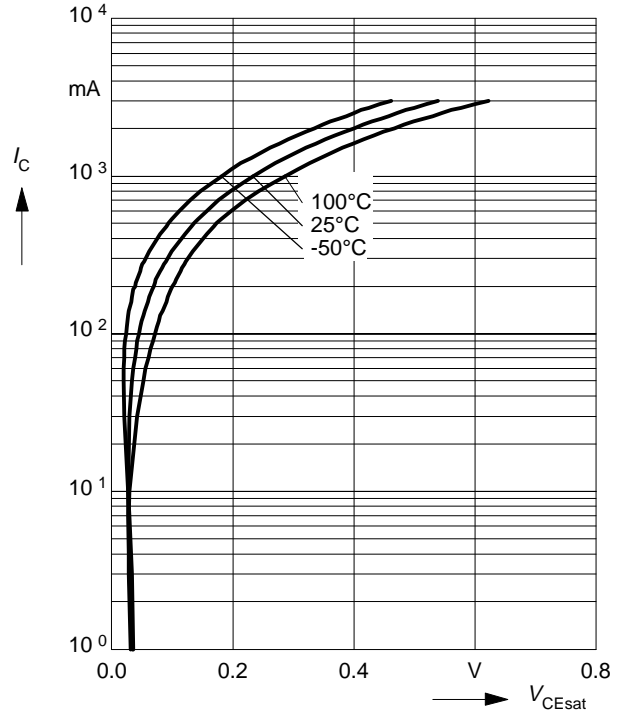

Base-emitter saturation voltage $I_C = f(V_{BEsat}), h_{FE} = 10$

$I_C = f(V_{BEsat}), h_{FE} = 10$

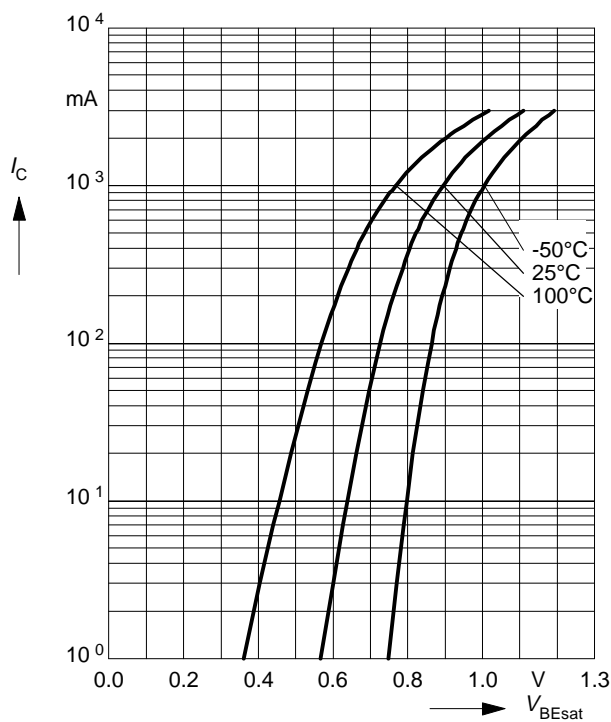

Collector current $I_C = f(V_{BE})$

$V_{CE} = 2V$

