



STRH40N25FSY3

N-channel 250V - 0.084Ω - TO-254AA
Rad-hard low gate charge STripFET™ Power MOSFET

PRELIMINARY DATA

Features

Type	V _{DSS}
STRH40N25FSY3	250V

- Low R_{DS(on)}
- Fast switching
- Single event effect (SEE) hardened
- Low total gate charge
- Light weight
- 100% avalanche tested
- Application oriented characterization
- Hermetically sealed
- Heavy ion SOA
- 100kRad TID
- SEL & SEGR with 34Mev/cm²/mg LET ions

Description

This Power MOSFET series realized with STMicroelectronics unique STripFET process has specifically been designed to improve immunity to space effect. It is therefore suitable as power switch in mainly high-efficiency DC-DC converters and Motor Control applications. It is also intended for any application with low gate charge drive requirements.

Applications

- Satellite
- High reliability applications

Order codes

Part number	Marking	Package	Packaging
STRH40N25FSY1 ⁽¹⁾	RH40N25FSY1	TO-254AA	Individual strip pack
STRH40N25FSY3 ⁽²⁾	RH40N25FSY3	TO-254AA	Individual strip pack

1. Mil temp range

2. Space flights parts (full ESA flow screening)

March 2007

Rev 2

1/13

This is preliminary information on a new product now in development or undergoing evaluation. Details are subject to change without notice.

www.st.com

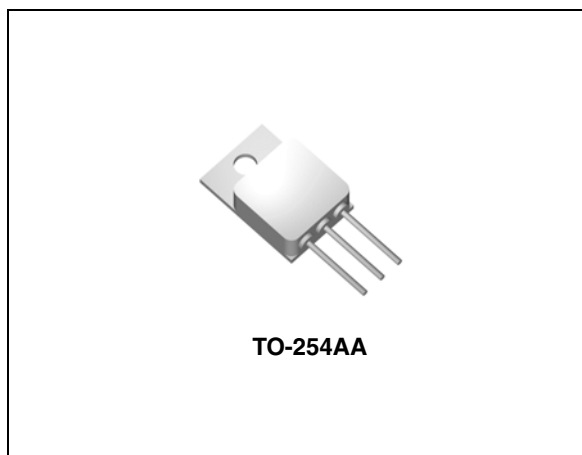

Internal schematic diagram

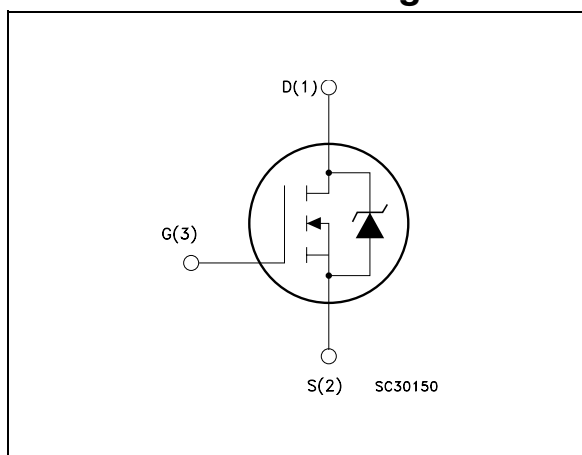

Contents

1	Electrical ratings	3
2	Electrical characteristics	4
	2.1 Pre-irradiation	4
	2.2 Post-irradiation	5
3	Test circuit	9
4	Package mechanical data	10
5	Revision history	11

1 Electrical ratings

Table 1. Absolute maximum ratings (pre-irradiation)

Symbol	Parameter	Value	Unit
V_{DS}	Drain-source voltage ($V_{GS} = 0$)	250	V
V_{GS}	Gate-source voltage	± 16	V
$I_D^{(1)}$	Drain current (continuous) at $T_C = 25^\circ\text{C}$	36	A
$I_D^{(1)}$	Drain current (continuous) at $T_C = 100^\circ\text{C}$	23	A
$I_{DM}^{(2)}$	Drain current (pulsed)	144	A
$P_{TOT}^{(1)}$	Total dissipation at $T_C = 25^\circ\text{C}$	278	W
$dv/dt^{(3)}$	Peak diode recovery voltage slope	4	V/ns
T_{stg}	Storage temperature	-55 to 150	$^\circ\text{C}$
T_j	Max. operating junction temperature	150	$^\circ\text{C}$

1. Rated according to the $R_{thj-case}$
2. Pulse width limited by safe operating area
3. $I_{SD} \leq 40\text{A}$, $di/dt \leq 400\text{A}/\mu\text{s}$, $V_{DD} = 80\% V_{(BR)DSS}$

Table 2. Thermal data

Symbol	Parameter	Value	Unit
$R_{thj-case}$	Thermal resistance junction-case	0.45	$^\circ\text{C}/\text{W}$
R_{thc-s}	Case-to-sink	0.21	$^\circ\text{C}/\text{W}$
$R_{thj-amb}$	Thermal resistance junction -amb	48	$^\circ\text{C}/\text{W}$

Table 3. Avalanche characteristics

Symbol	Parameter	Value	Unit
I_{AR}	Avalanche current, repetitive or not-repetitive (pulse width limited by $T_j \text{ Max}$)	40	A
E_{AS}	Single pulse avalanche energy (starting $T_j = 25^\circ\text{C}$, $I_d = I_{AR}$, $V_{DD} = 50\text{V}$)	320	mJ
E_{AR}	Repetitive avalanche	25	mJ

2 Electrical characteristics

($T_{CASE} = 25^{\circ}C$ unless otherwise specified)

2.1 Pre-irradiation

Table 4. On/off states

Symbol	Parameter	Test conditions	Min.	Typ.	Max.	Unit
I_{DSS}	Zero gate voltage drain current ($V_{GS} = 0$)	80% BV_{DSS}			10	μA
I_{GSS}	Gate body leakage current ($V_{DS} = 0$)	$V_{GS} = \pm 16V$			± 100	nA
BV_{DSS}	Drain-to-source breakdown voltage	$I_D = 1mA, V_{GS} = 0V$	250			V
$V_{GS(th)}$	Gate threshold voltage	$V_{DS} = V_{GS}, I_D = 1mA$	2		4.5	V
$R_{DS(on)}$	Static drain-source on resistance	$V_{GS} = 12V, I_D = 20A$		0.084	0.1	Ω

Table 5. Dynamic

Symbol	Parameter	Test conditions	Min.	Typ.	Max.	Unit
C_{iss} C_{oss} C_{rss}	Input capacitance Output capacitance Reverse transfer capacitance	$V_{DS} = 0V, f = 1MHz,$ $V_{GS} = 12V$		9100 650 45		pF pF pF
Q_g Q_{gs} Q_{gd}	Total gate charge Gate-to-source charge Gate-to-drain ("Miller") charge	$V_{DD} = 200V, I_D = 40A,$ $V_{GS} = 12V$		202 34 58	280 47 80	nC nC nC
R_G	Gate input resistance	f=1MHz Gate DC Bias=0 Test signal level=20mV open drain		1.4	3	Ω

Table 6. Switching times

Symbol	Parameter	Test conditions	Min.	Typ.	Max	Unit
$t_{d(on)}$ t_r $t_{d(off)}$ t_f	Turn-on delay time Rise time Turn-off-delay time Fall time	$V_{DD} = 125V, I_D = 40A,$ $R_G = 4.7\Omega, V_{GS} = 12V$		33 80 123 145		ns ns ns ns

Table 7. Source drain diode

Symbol	Parameter	Test conditions	Min.	Typ.	Max	Unit
I_{SD}	Source-drain current				36	A
$I_{SDM}^{(1)}$	Source-drain current (pulsed)				144	A
$V_{SD}^{(2)}$	Forward on voltage	$I_{SD} = 40A, V_{GS} = 0$			1.5	V
t_{rr}	Reverse recovery time	$I_{SD} = 40A, di/dt = 100A/\mu s$ $V_{DD} = 50V, T_j = 150^\circ C$		484		ns
Q_{rr}	Reverse recovery charge			8.4		μC
I_{RRM}	Reverse recovery current			35		A

1. Pulse width limited by safe operating area
2. Pulsed: pulse duration = 300 μs , duty cycle 1.5%

2.2 Post-irradiation

The ST Rad-Hard Power MOSFETs are tested to verify the radiation capability. The technology is extremely resistant to assurance well functioning of the device inside the radiation environments. Every manufacturing lot is tested for total ionizing dose.

(@ $T_j=25^\circ C$ up to 100Krad ^(a))

Table 8. On/off states

Symbol	Parameter	Test conditions	Min.	Typ.	Max.	Unit
I_{DSS}	Zero gate voltage drain current ($V_{GS} = 0$)	80% BV_{DSS}			10	μA
I_{GSS}	Gate body leakage current ($V_{DS} = 0$)	$V_{GS} = \pm 16V$			± 100	nA
BV_{DSS}	Drain-to-source breakdown voltage	$I_D = 1mA, V_{GS} = 0V$	250			V
$V_{GS(th)}$	Gate threshold voltage	$V_{DS} = V_{GS}, I_D = 1mA$	2		4.5	V
$R_{DS(on)}$	Static drain-source on resistance	$V_{GS} = 12V, I_D = 20A$		0.084	0.1	Ω

- a. According to ESCC 22900 specification, Co60 gamma rays, dose rags:0.1rad/sec.

Table 9. Single event effect, SOA⁽¹⁾

Ion	Let (Mev/(mg/cm ²))	Energy (MeV)	Range (μm)	V _{DS} (V) @V _{GS} 0V
Kr	34	316	43	250
Xe	55.9	459	43	244

1. Rad-Hard Power MOSFETs have been characterized in heavy ion environment for single event effect (SEE). Single event effect characterization is illustrated

Table 10. Source drain diode

Symbol	Parameter	Test conditions	Min.	Typ.	Max	Unit
I _{SD}	Source-drain current				36	A
I _{SDM} ⁽¹⁾	Source-drain current (pulsed)				144	A
V _{SD} ⁽²⁾	Forward on voltage	I _{SD} = 40A, V _{GS} = 0			1.5	V
t _{rr}	Reverse recovery time	I _{SD} = 40A, di/dt = 100A/μs V _{DD} = 50V, T _j = 150°C		484		ns
Q _{rr}	Reverse recovery charge			8.4		μC
I _{RRM}	Reverse recovery current			35		A

1. Pulse width limited by safe operating area
 2. Pulsed: pulse duration = 300μs, duty cycle 1.5%

2.3 Electrical characteristics (curves)

Figure 1. Safe operating area

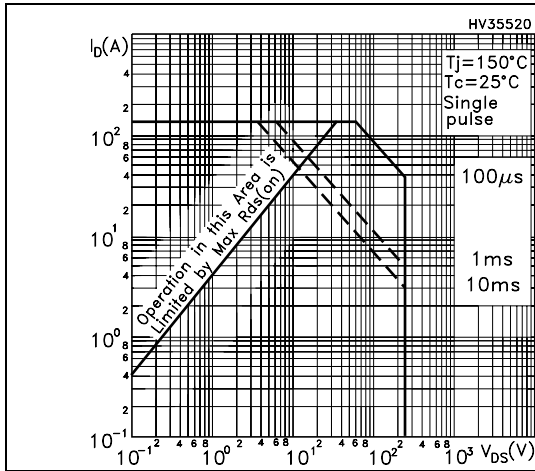

Figure 2. Thermal impedance

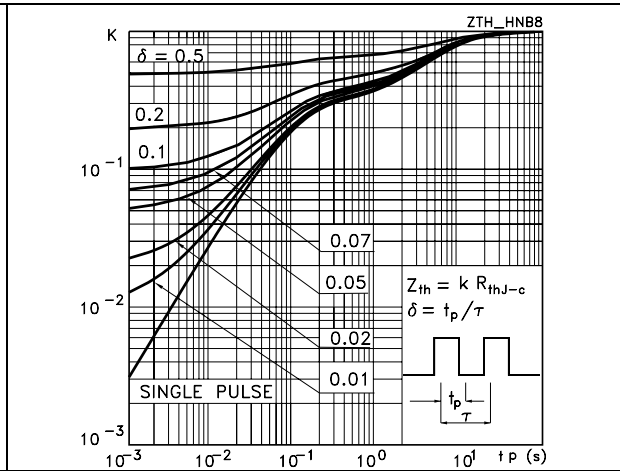

Figure 3. Output characteristics

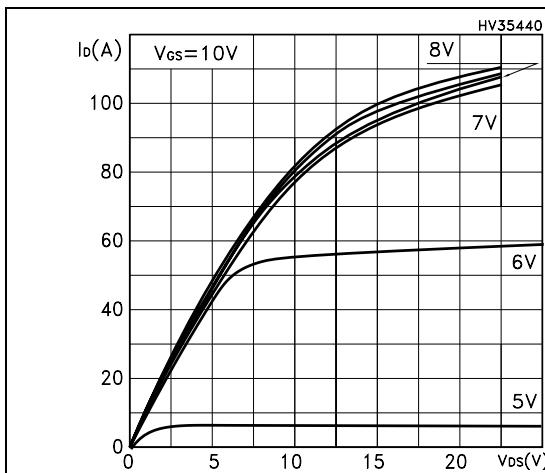

Figure 4. Transfer characteristics

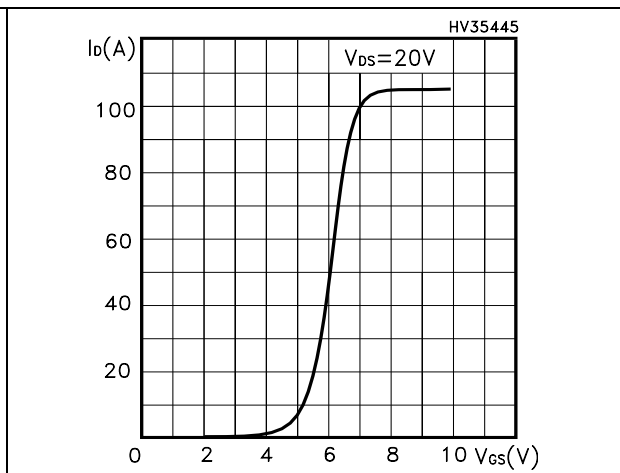

Figure 5. Gate charge vs. gate-source voltage

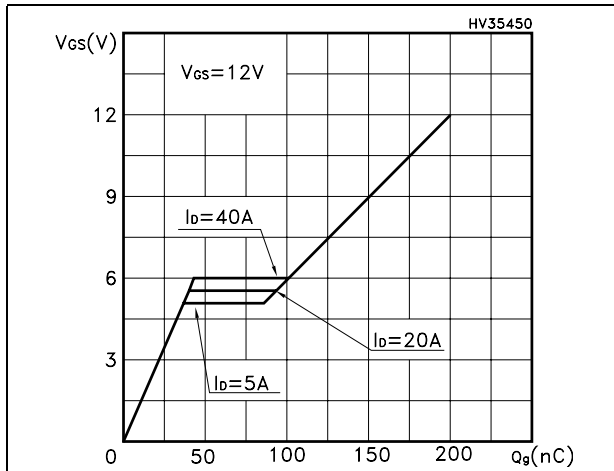

Figure 6. Capacitance variations

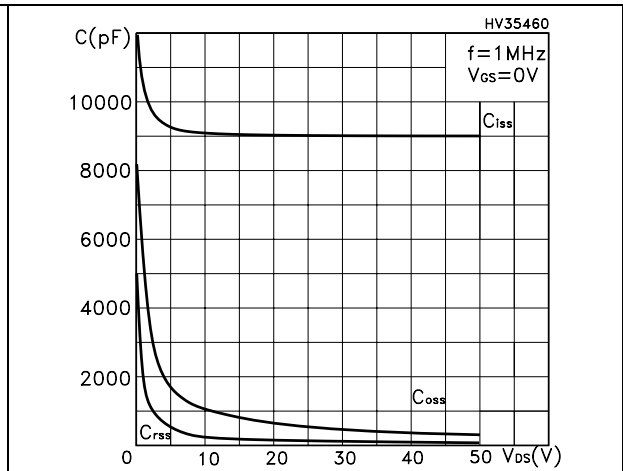

Figure 7. Normalized BV_{DSS} vs. temperature

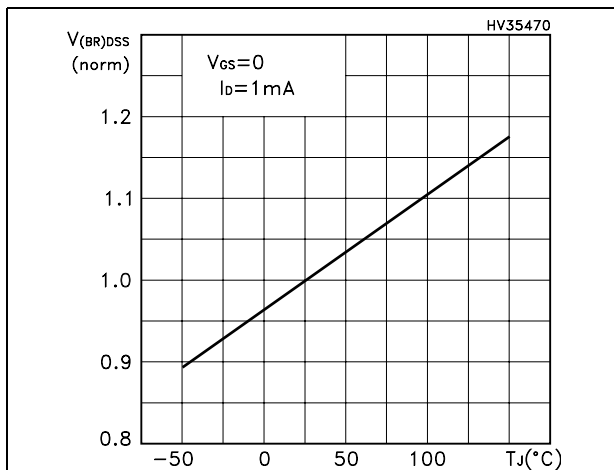

Figure 8. Static drain-source on resistance

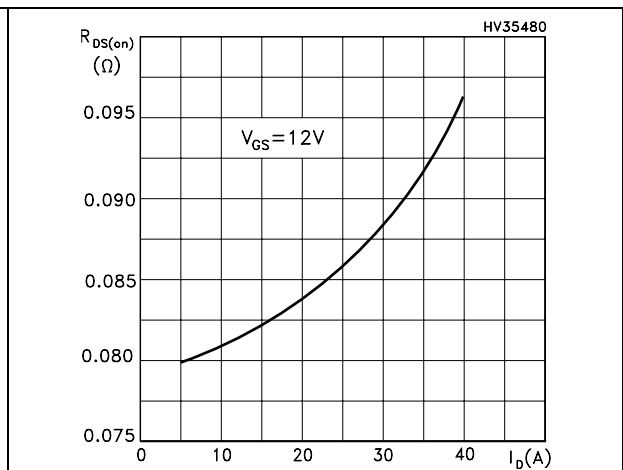

Figure 9. Normalized gate threshold voltage vs. temperature

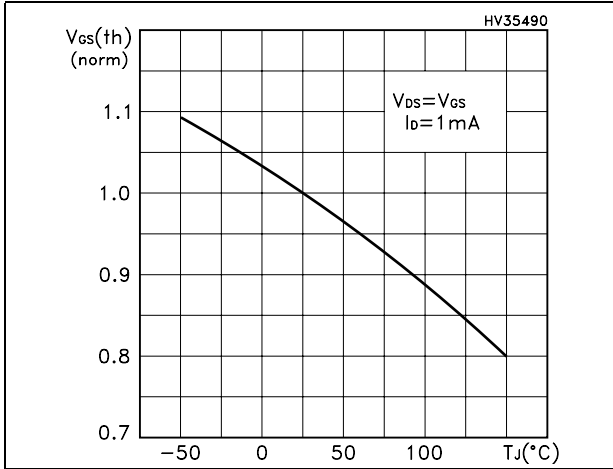

Figure 10. Normalized on resistance vs. temperature

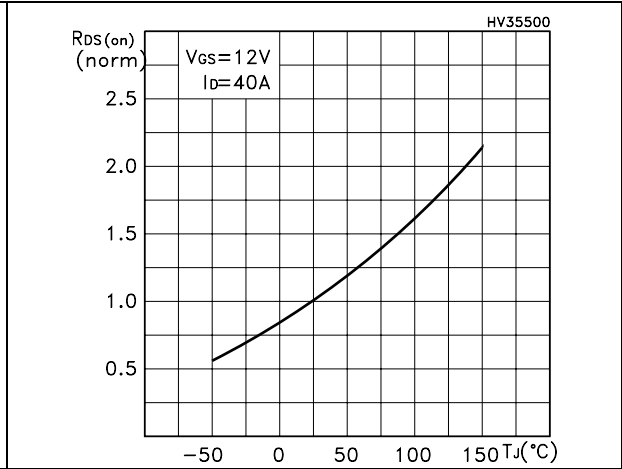
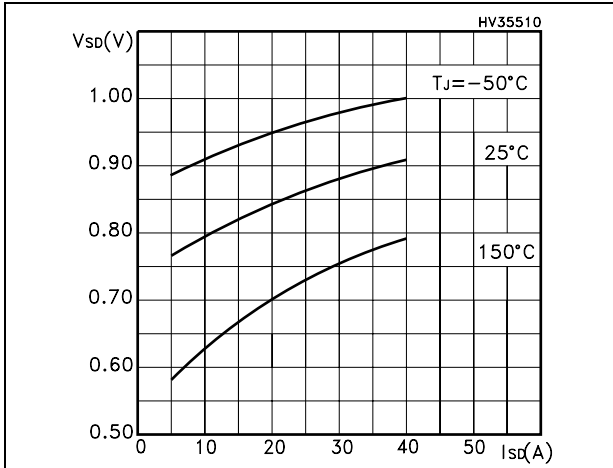
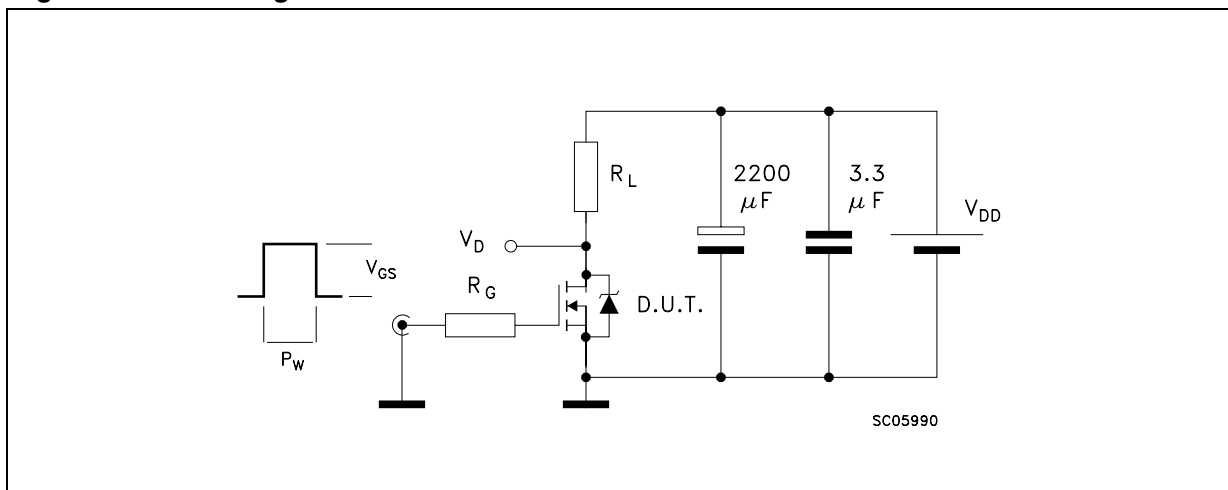

Figure 11. Source drain-diode forward characteristics



3 Test circuit

Figure 12. Switching times test circuit for resistive load (1)



1. Max driver V_{GS} slope = 1V/ns (no DUT)

4 Package mechanical data

TO-254AA MECHANICAL DATA

DIM.	mm.			inch		
	MIN.	TYP	MAX.	MIN.	TYP.	MAX.
A	13.59		13.84	0.535		0.545
B	13.59		13.84	0.535		0.545
C	20.07		20.32	0.790		0.80
D	6.32		6.60	0.249		0.260
E	1.02		1.27	0.040		0.050
F	3.53		3.78	0.139		0.149
G	16.89		17.40	0.665		0.685
H		6.86			0.270	
I	0.89		1.14	0.035		0.045
J		3.81			0.150	
K		3.81			0.150	
L	12.95		14.50	0.510		0.570
M		3.05			0.120	
N			0.71			0.025
R1			1.0			0.040
R2		1.65			0.065	

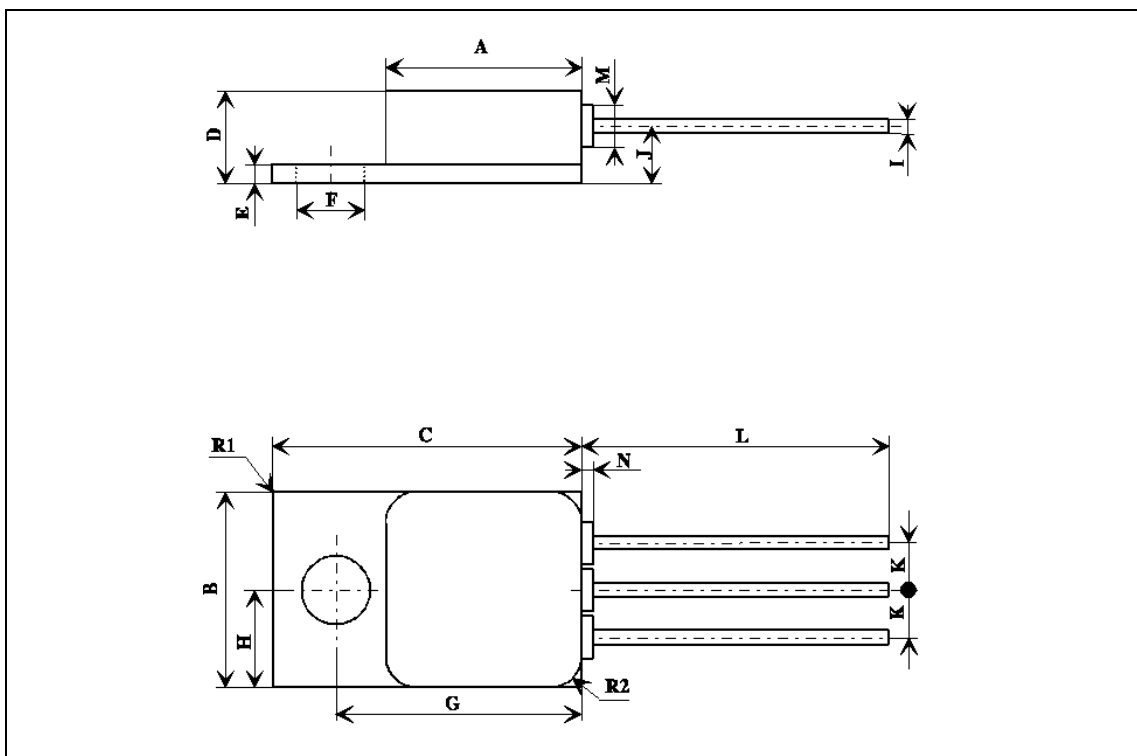

5 Revision history

Table 11. Revision history

Date	Revision	Changes
18-Dec-2006	1	First release
02-Mar-2007	2	Some values changed on Table 4 and Table 8

Please Read Carefully:

Information in this document is provided solely in connection with ST products. STMicroelectronics NV and its subsidiaries ("ST") reserve the right to make changes, corrections, modifications or improvements, to this document, and the products and services described herein at any time, without notice.

All ST products are sold pursuant to ST's terms and conditions of sale.

Purchasers are solely responsible for the choice, selection and use of the ST products and services described herein, and ST assumes no liability whatsoever relating to the choice, selection or use of the ST products and services described herein.

No license, express or implied, by estoppel or otherwise, to any intellectual property rights is granted under this document. If any part of this document refers to any third party products or services it shall not be deemed a license grant by ST for the use of such third party products or services, or any intellectual property contained therein or considered as a warranty covering the use in any manner whatsoever of such third party products or services or any intellectual property contained therein.

UNLESS OTHERWISE SET FORTH IN ST'S TERMS AND CONDITIONS OF SALE ST DISCLAIMS ANY EXPRESS OR IMPLIED WARRANTY WITH RESPECT TO THE USE AND/OR SALE OF ST PRODUCTS INCLUDING WITHOUT LIMITATION IMPLIED WARRANTIES OF MERCHANTABILITY, FITNESS FOR A PARTICULAR PURPOSE (AND THEIR EQUIVALENTS UNDER THE LAWS OF ANY JURISDICTION), OR INFRINGEMENT OF ANY PATENT, COPYRIGHT OR OTHER INTELLECTUAL PROPERTY RIGHT.

UNLESS EXPRESSLY APPROVED IN WRITING BY AN AUTHORIZED ST REPRESENTATIVE, ST PRODUCTS ARE NOT RECOMMENDED, AUTHORIZED OR WARRANTED FOR USE IN MILITARY, AIR CRAFT, SPACE, LIFE SAVING, OR LIFE SUSTAINING APPLICATIONS, NOR IN PRODUCTS OR SYSTEMS WHERE FAILURE OR MALFUNCTION MAY RESULT IN PERSONAL INJURY, DEATH, OR SEVERE PROPERTY OR ENVIRONMENTAL DAMAGE. ST PRODUCTS WHICH ARE NOT SPECIFIED AS "AUTOMOTIVE GRADE" MAY ONLY BE USED IN AUTOMOTIVE APPLICATIONS AT USER'S OWN RISK.

Resale of ST products with provisions different from the statements and/or technical features set forth in this document shall immediately void any warranty granted by ST for the ST product or service described herein and shall not create or extend in any manner whatsoever, any liability of ST.

ST and the ST logo are trademarks or registered trademarks of ST in various countries.

Information in this document supersedes and replaces all information previously supplied.

The ST logo is a registered trademark of STMicroelectronics. All other names are the property of their respective owners.

© 2007 STMicroelectronics - All rights reserved

STMicroelectronics group of companies

Australia - Belgium - Brazil - Canada - China - Czech Republic - Finland - France - Germany - Hong Kong - India - Israel - Italy - Japan - Malaysia - Malta - Morocco - Singapore - Spain - Sweden - Switzerland - United Kingdom - United States of America

www.st.com

