



S486

CMOS IC

DUAL 100mW AUDIO POWER AMPLIFIER WITH STANDBY MODE

DESCRIPTION

The UTC **S486** is a dual power amplifier capable of delivering typically 100mW per channel of continuous average power to an 8Ω load with 0.1% THD+N using a 5V power supply.

The UTC **S486** features an externally controlled, low-power consumption shutdown mode. The UTC **S486** exhibit a low quiescent current of typically 1.8mA, allowing usage in portable applications.

The unity-gain stable UTC S486 can be configured by external gain-setting resistors.

FEATURES

- * Operating voltage range $V_{CC}=2V \sim 5.5V$
- * Output power:
 - 102mW @5V into 16Ω with 0.1% THD+N max (1kHz)
- * Shutdown mode available
- * Low current consumption: 2.5mA max
- * Click and pop reduction circuitry
- * Unity-gain stable
- * Short circuit protected

ORDERING INFORMATION

Order Number		Package	Packing
Normal	Lead Free Plating		
S486-S08-R	S486L-S08-R	SOP-8	Tape Reel
S486-S08-T	S486L-S08-T	SOP-8	Tube

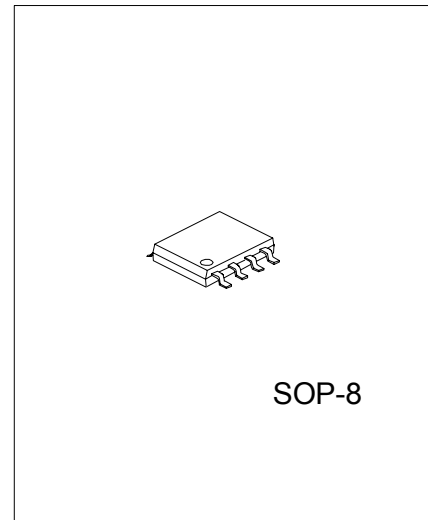

SOP-8

*Pb-free plating product number: S486L

<p>S486L-S08-R</p> <p>(1)Packing Type (2)Package Type (3)Lead Plating</p>	<p>(1) R: Tape Reel, T: Tube (2) S08: SOP-8 (3) L: Lead Free Plating, Blank: Pb/Sn</p>
---	--

■ PIN CONFIGURATION

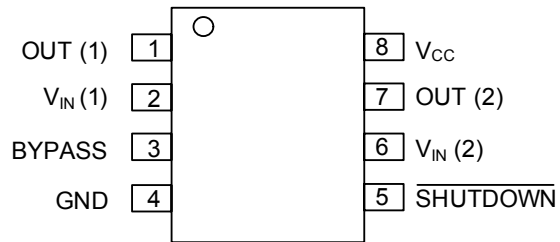

■ ABSOLUTE MAXIMUM RATING (Ta=25)

PARAMETER	SYMBOL	RATINGS	UNIT
Supply voltage (Note 2)	V _{CC}	6	V
Input Voltage	V _{IN}	-0.3V ~ V _{CC} +0.3V	V
Output Short-Circuit to V _{CC} or GND		Continuous(Note 3)	
Power Dissipation (T _J =150)	P _D	0.71	W
Junction Temperature	T _J	+150	
Operating Temperature	T _{OPR}	-40 ~ +85	
Storage Temperature	T _{STG}	-65 ~ +150	

Note: 1. Absolute maximum ratings are those values beyond which the device could be permanently damaged.

Absolute maximum ratings are stress ratings only and functional device operation is not implied.

2. All voltage values are measured with respect to the ground pin.

3. Attention must be paid to continuous power dissipation (V_{DD} x 300mA). Exposure of the I_C to a short circuit for an extended time period is dramatically reducing product life expectancy.

■ THERMAL DATA

PARAMETER	SYMBOL	RATINGS	UNIT
Thermal Resistance Junction to Ambient	θ _{JA}	175	/W

■ RECOMMENDED OPERATING CONDITIONS

PARAMETER	SYMBOL	RATINGS	UNIT
Supply Voltage	V _{CC}	2 ~ 5.5	V
Shutdown Voltage Input	ACTIVE	1.5 ≤ V _{SHDN} ≤ V _{CC}	V
	SHUTDOWN	GND ≤ V _{SHDN} ≤ 0.4 (Note)	
Load Resistor	R _L	≥ 16	Ω
Load Capacitor	R _L = 16 ~ 100Ω	400	pF
	R _L > 100Ω	100	
Thermal Resistance Junction to Ambient	θ _{JA}	150	/W

Note: The minimum current consumption (I_{SHDN}) is guaranteed at GND for the whole temperature range.

■ ELECTRICAL CHARACTERISTICS (Ta = 25 °C, GND = 0V, unless otherwise specified)

For V_{CC} = +5V

PARAMETER	SYMBOL	TEST CONDITIONS	MIN	TYP	MAX	UNIT
Output Swing	V _{OUT}	V _{OL} : R _L = 32Ω		0.45	0.5	V
		V _{OH} : R _L = 32Ω	4.45	4.52		
		V _{OL} : R _L = 16Ω		0.6	0.7	
		V _{OH} : R _L = 16Ω	4.2	4.35		
Input Offset Voltage	V _{I(OFF)}	V _{ICM} = V _{CC} /2		1		mV
Supply Current	I _{CC}	No input signal, no load		1.8	2.5	mA
Shutdown Current	I _{SHDN}	No input signal, V _{SHDN} =GND, R _L =32Ω		10	1000	nA
Input Bias Current	I _{I(BIAS)}	V _{ICM} = V _{CC} /2		90	200	nA
Max Output Current	I _{OUT}	THD+N≤1%, R _L =16Ω connected between out and V _{CC} /2	106	115		mA
Output Power	P _{OUT}	THD+N = 0.1% Max, F= 1kHz	R _L = 16Ω		102	mW
			R _L = 32Ω		64	
		THD+N = 1% Max, F= 1kHz	R _L = 16Ω	95	108	
			R _L = 32Ω	60	65	
Total Harmonic Distortion + Noise (G _v =-1)	THD+N	R _L = 32Ω, P _{OUT} = 60mW, 20Hz≤F≤20kHz		0.3		%
		R _L = 16Ω, P _{OUT} = 90mW, 20Hz≤F≤20kHz		0.3		
Power Supply Rejection Ratio	PSRR	inputs grounded(G _v =-1)(Note), R _L = 16Ω, C _B =1mF, F = 1kHz, V _{RIPPLE} = 200mV _{PP}	53	58		dB
Signal-to-Noise Ratio	SNR	(A weighted, G _v =-1)(Note), R _L = 32Ω, THD +N < 0.4%, 20Hz≤F≤20kHz	80	103		dB
Crosstalk	CT	Channel Separation, G _v =-1, F = 1kHz	R _L = 16Ω		80	dB
			R _L = 32Ω		83	
		Channel Separation, G _v =-1, F = 20Hz ~ 20kHz	R _L = 16Ω		72	
			R _L = 32Ω		79	
Input Capacitance	C _{IN}			1		pF
Gain Bandwidth Product	GB _W	R _L = 32Ω		1.1		MHz
Slew Rate	SR	Unity Gain Inverting(R _L = 16Ω)		0.4		V/μs

Note: Guaranteed by design and evaluation.

■ ELECTRICAL CHARACTERISTICS(Cont.) (Ta = 25 °C, GND = 0V, unless otherwise specified)

For V_{CC} = +3.3V

PARAMETER	SYMBOL	TEST CONDITIONS	MIN	TYP	MAX	UNIT	
Output Swing	V _{OUT}	V _{OL} : R _L = 32Ω		0.3	0.38	V	
		V _{OH} : R _L = 32Ω	2.85	3			
		V _{OL} : R _L = 16Ω		0.45	0.52		
		V _{OH} : R _L = 16Ω	2.68	2.85			
Input Offset Voltage	V _{I(OFF)}	V _{ICM} = V _{CC} /2		1		mV	
Supply Current	I _{CC}	No input signal, no load		1.8	2.5	mA	
Shutdown Current	I _{SHDN}	No input signal, V _{SHDN} =GND, R _L =32Ω		10	1000	nA	
Input Bias Current	I _{I(BIAS)}	V _{ICM} = V _{CC} /2		90	200	nA	
Max Output Current	I _{OUT}	THD +N≤1%, R _L = 16Ω connected between out and V _{CC} /2	64	75		mA	
Output Power	P _{OUT}	THD+N = 0.1% Max, F= 1kHz	R _L = 16Ω		38		mW
			R _L = 32Ω		26		
		THD+N = 1% Max, F= 1kHz	R _L = 16Ω	36	42		
			R _L = 32Ω	23	28		
Total Harmonic Distortion + Noise (G _v =-1)	THD+N	R _L = 32Ω, P _{OUT} = 60mW, 20Hz≤F≤20kHz		0.3		%	
		R _L = 16Ω, P _{OUT} = 90mW, 20Hz≤F≤20kHz		0.3			
Power Supply Rejection Ratio	PSRR	inputs grounded (G _v =-1)(Note 2), R _L = 16Ω, C _B =1mF, F = 1kHz, V _{RIPPLE} = 200mV _{PP}	53	58		dB	
Signal-to-Noise Ratio	SNR	(A weighted, G _v =-1)(Note 2), R _L = 32Ω, THD +N < 0.4%, 20Hz≤F≤20kHz	80	98		dB	
Crosstalk	CT	Channel Separation, G _v =-1, F = 1kHz	R _L = 16Ω		77		dB
			R _L = 32Ω		80		
		Channel Separation, G _v =-1, F = 20Hz ~ 20kHz	R _L = 16Ω		69		
			R _L = 32Ω		76		
Input Capacitance	C _{IN}			1		pF	
Gain Bandwidth Product	GBw	R _L = 32Ω		1.1		MHz	
Slew Rate	SR	Unity Gain Inverting(R _L = 16Ω)		0.4		V/μs	

Note 1. All electrical values are guaranteed with correlation measurements at 2V and 5V.

2. Guaranteed by design and evaluation.

■ ELECTRICAL CHARACTERISTICS(Cont.) (Ta = 25 °C, GND = 0V, unless otherwise specified)

For V_{CC} = +2.5V

PARAMETER	SYMBOL	TEST CONDITIONS	MIN	TYP	MAX	UNIT
Output Swing	V _{OUT}	V _{OL} : R _L = 32Ω		0.25	0.32	V
		V _{OH} : R _L = 32Ω	2.14	0.25		
		V _{OL} : R _L = 16Ω		0.35	0.45	
		V _{OH} : R _L = 16Ω	1.97	2.15		
Input Offset Voltage	V _{I(OFF)}	V _{ICM} = V _{CC} /2		1		mV
Supply Current	I _{CC}	No input signal, no load		1.7	2.5	mA
Shutdown Current	I _{SHDN}	No input signal, V _{SHDN} =GND, R _L =32Ω		10	1000	nA
Input Bias Current	I _{I(BIAS)}	V _{ICM} = V _{CC} /2		90	200	nA
Max Output Current	I _{OUT}	THD +N 1%, R _L = 16Ω connected between out and V _{CC} /2	45	56		mA
Output Power	P _{OUT}	THD+N = 0.1% Max, F= 1kHz	R _L = 16Ω		21	mW
			R _L = 32Ω		13	
		THD+N = 1% Max, F= 1kHz	R _L = 16Ω	17.5	22	
			R _L = 32Ω	12.5	14	
Total Harmonic Distortion + Noise (G _v =-1)	THD+N	R _L = 32Ω, P _{OUT} = 60mW, 20Hz ~ 20kHz		0.3		%
		R _L = 16Ω, P _{OUT} = 90mW, 20Hz ~ 20kHz		0.3		
Power Supply Rejection Ratio	PSRR	inputs grounded(G _v =-1)(Note 2), R _L = 16Ω, C _B =1mF, F = 1kHz, V _{RIPPLE} = 200mV _{PP}	53	58		dB
Signal-to-Noise Ratio	SNR	(A weighted, A _v =-1)(Note 2), R _L = 32Ω, THD +N < 0.4%, 20Hz ~ 20kHz	80	95		dB
Crosstalk	CT	Channel Separation, G _v =-1, F = 1kHz	R _L = 16Ω		77	dB
			R _L = 32Ω		80	
		Channel Separation, G _v =-1, F = 20Hz ~ 20kHz	R _L = 16Ω		69	
			R _L = 32Ω		76	
Input Capacitance	C _{IN}			1		pF
Gain Bandwidth Product	GBP	R _L = 32Ω		1.1		MHz
Slew Rate	SR	Unity Gain Inverting (R _L = 16Ω)		0.4		V/μs

Note 1. All electrical values are guaranteed with correlation measurements at 2V and 5V.

2. Guaranteed by design and evaluation.

■ ELECTRICAL CHARACTERIST(Cont.) (Ta = 25 , GND = 0V, unless otherwise specified)

For V_{CC} = +2V

PARAMETER	SYMBOL	TEST CONDITIONS	MIN	TYP	MAX	UNIT
Output Swing	V _{OUT}	V _{OL} : R _L = 32Ω		0.24	0.29	V
		V _{OH} : R _L = 32Ω	1.67	1.73		
		V _{OL} : R _L = 16Ω		0.33	0.41	
		V _{OH} : R _L = 16Ω	1.53	1.63		
Input Offset Voltage	V _{I(OFF)}	V _{ICM} = V _{CC} /2		1		mV
Supply Current	I _{CC}	No input signal, no load		1.7	2.5	mA
Shutdown Current	I _{SHDN}	No input signal, V _{SHDN} =GND, R _L =32Ω		10	1000	nA
Input Bias Current	I _{I(BIAS)}	V _{ICM} = V _{CC} /2		90	200	nA
Max Output Current	I _{OUT}	THD +N = 1%, R _L =16Ω connected between out and V _{CC} /2	33	41		mA
Output Power	P _{OUT}	THD+N = 0.1% Max, F= 1kHz	R _L = 16Ω		12	mW
			R _L = 32Ω		8	
		THD+N = 1% Max, F= 1kHz	R _L = 16Ω	9.5	13	
			R _L = 32Ω	7	9	
Total Harmonic Distortion + Noise (G _v =-1)	THD+N	R _L = 32Ω, P _{OUT} = 60mW, 20Hz F 20kHz		0.3		%
		R _L = 16Ω, P _{OUT} = 90mW, 20Hz F 20kHz		0.3		
Power Supply Rejection Ratio	PSRR	inputs grounded (G _v =-1)(Note) ,R _L = 16Ω, C _B =1mF, F = 1kHz, V _{RIPPLE} = 200mV _{PP}	52	57		dB
Signal-to-Noise Ratio	SNR	(A weighted, G _v =-1)(Note), R _L = 32Ω, THD +N < 0.4%, 20Hz≤F≤20kHz	80	93		dB
Crosstalk	CT	Channel Separation, G _v =-1, F = 1kHz	R _L = 16Ω		77	dB
			R _L = 32Ω		80	
		Channel Separation, G _v =-1, F = 20Hz ~ 20kHz	R _L = 16Ω		69	
			R _L = 32Ω		76	
Input Capacitance	C _{IN}			1		pF
Gain Bandwidth Product	GBP	R _L = 32Ω		1.1		MHz
Slew Rate	SR	Unity Gain Inverting (R _L = 16Ω)		0.4		V/μs

Note: Guaranteed by design and evaluation.

■ TYPICAL APPLICATION CIRCUIT

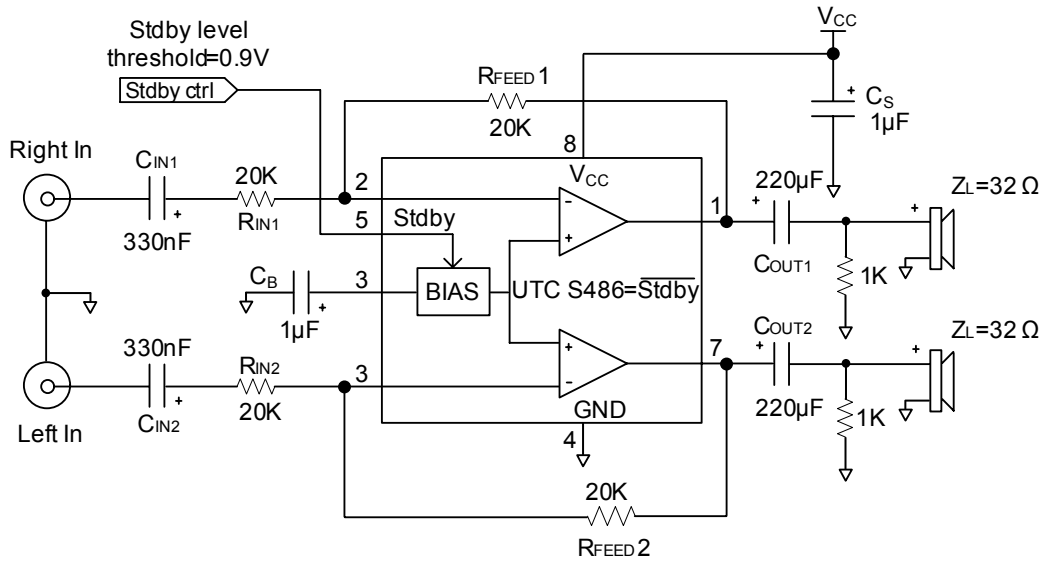

COMPONENTS INFORMATION

Components	Functional Description
$R_{IN1,2}$	Inverting input resistor which sets the closed loop gain in conjunction with R_{FEED} . This resistor also forms a high pass filter with C_{IN} ($f_c = 1 / (2 \times R_{IN} \times C_{IN})$).
$C_{IN1,2}$	Input coupling capacitor which blocks the DC voltage at the amplifier's input terminal.
$R_{FEED1,2}$	Feedback resistor which sets the closed loop gain in conjunction with R_{IN} . $A_V = \text{Closed Loop Gain} = -R_{FEED}/R_{IN}$.
C_S	Supply Bypass capacitor which provides power supply filtering.
C_B	Bypass capacitor which provides half supply filtering.
$C_{OUT1,2}$	Output coupling capacitor which blocks the DC voltage at the load input terminal. This capacitor also forms a high pass filter with R_L ($f_c = 1 / (2 \times R_L \times C_{OUT})$).

■ TYPICAL CHARACTERISTICS

Fig1. THD + N vs Frequency

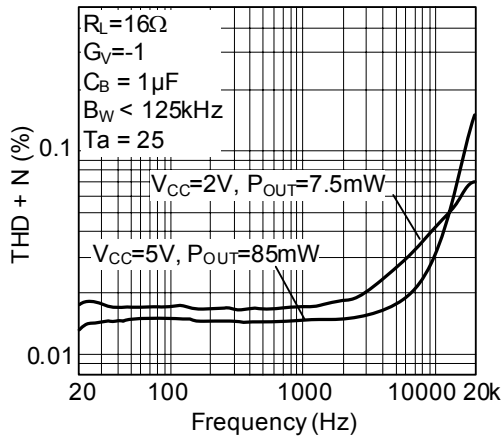

Fig 2. THD + N vs Frequency

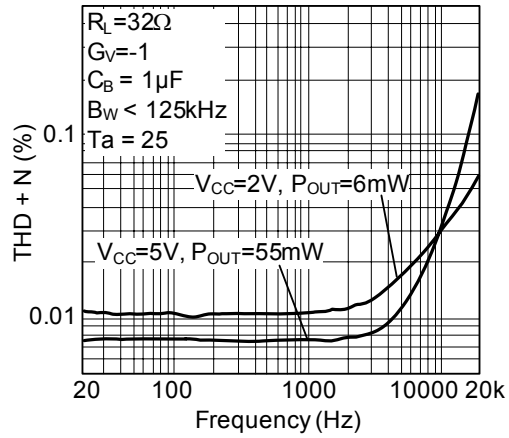

Fig 3. THD + N vs Output Power

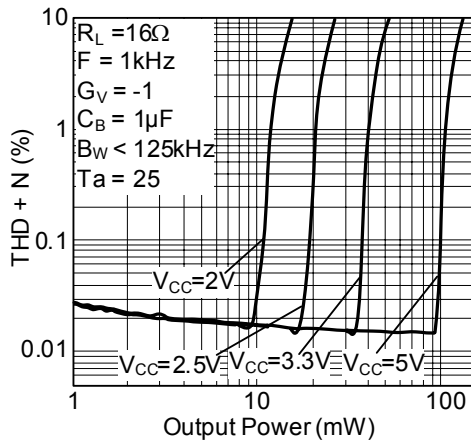

Fig 4. THD + N vs Output Power

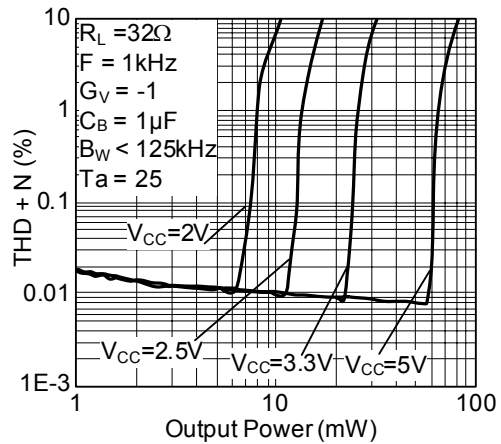

Fig 5. THD + N vs Output Power

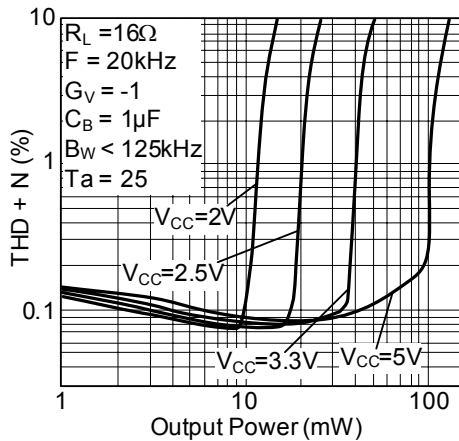
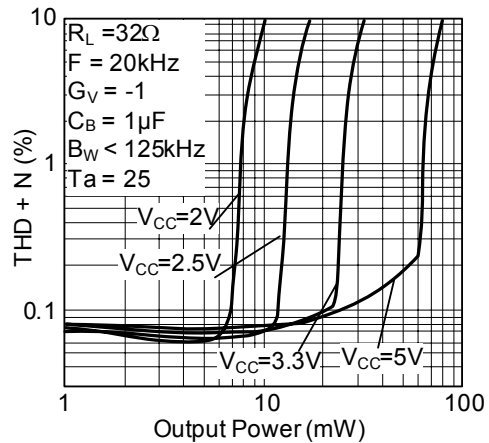

Fig 6. THD + N vs Output Power



■ TYPICAL CHARACTERISTICS(Cont.)

Fig 7. Open Loop Gain and Phase vs Frequency

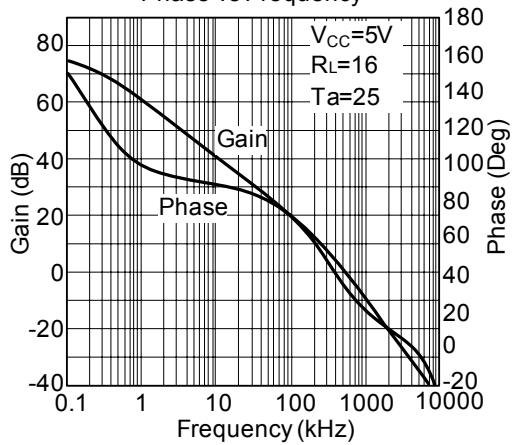

Fig 8. Open Loop Gain and Phase vs Frequency

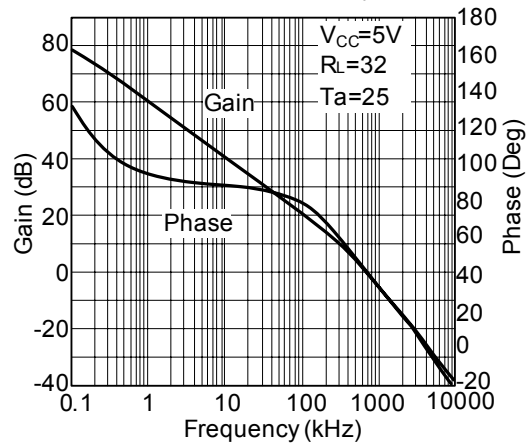

Fig 9. Open Loop Gain and Phase vs Frequency

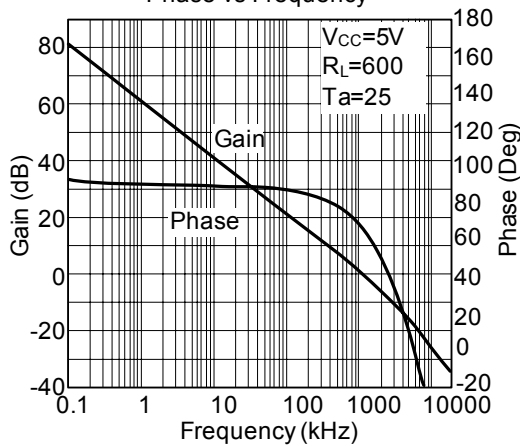

Fig 10. Output Power vs Power Supply Voltage

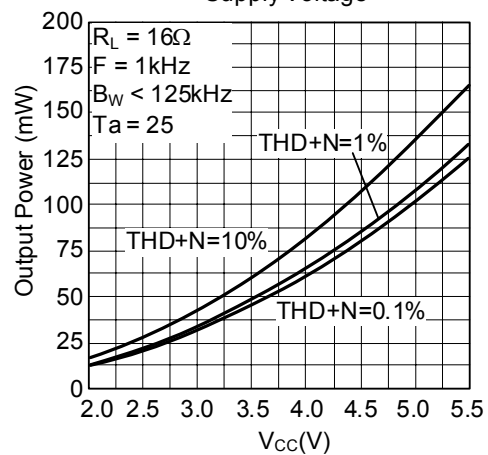

Fig 11. Output Power vs Power Supply Voltage

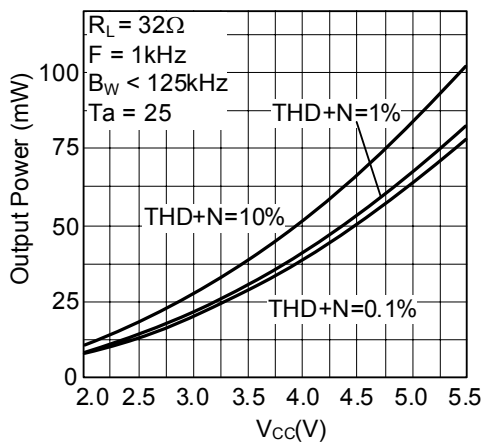
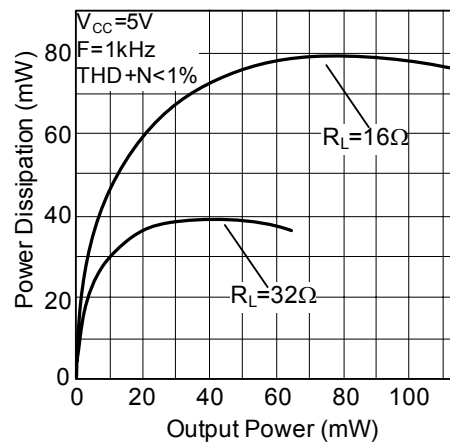
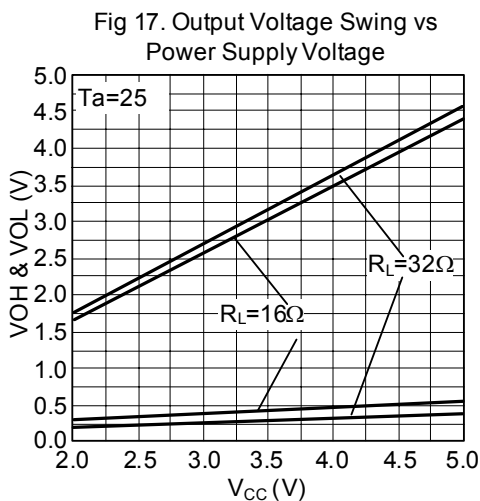
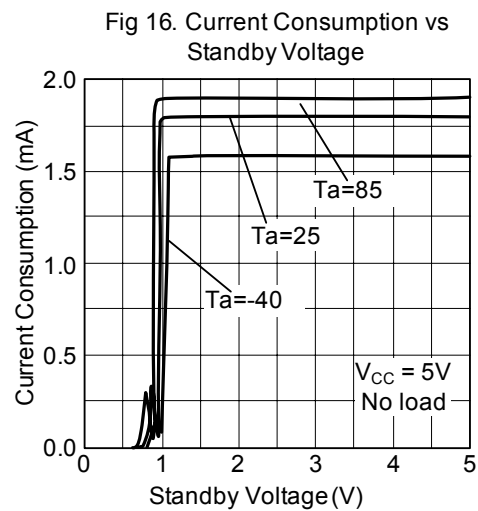
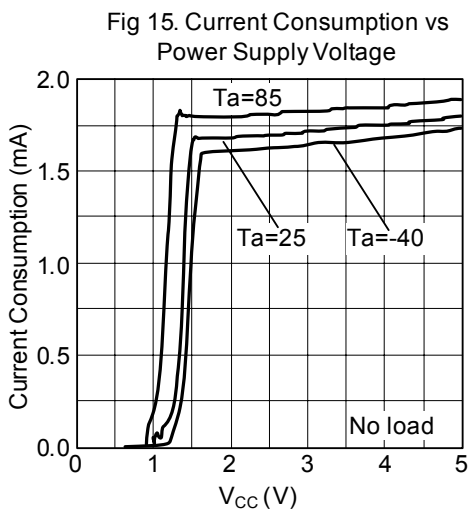
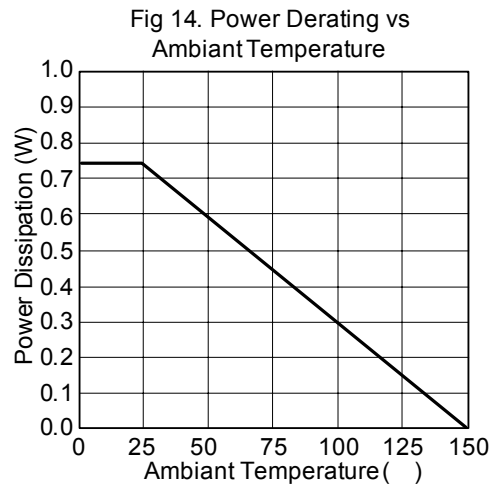
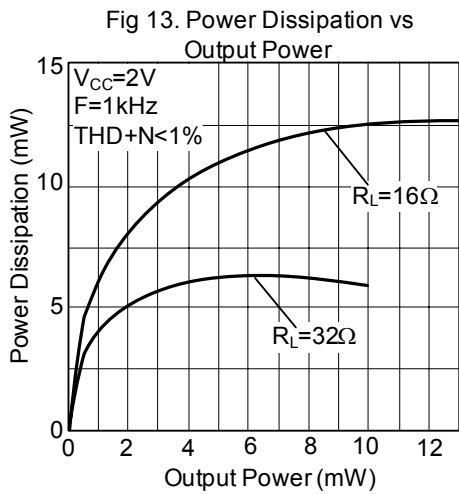

Fig 12. Power Dissipation vs Output Power



■ TYPICAL CHARACTERISTICS(Cont.)



UTC assumes no responsibility for equipment failures that result from using products at values that exceed, even momentarily, rated values (such as maximum ratings, operating condition ranges, or other parameters) listed in products specifications of any and all UTC products described or contained herein. UTC products are not designed for use in life support appliances, devices or systems where malfunction of these products can be reasonably expected to result in personal injury. Reproduction in whole or in part is prohibited without the prior written consent of the copyright owner. The information presented in this document does not form part of any quotation or contract, is believed to be accurate and reliable and may be changed without notice.