

Dual N-Channel 30-V (D-S) MOSFET with Schottky Diode

PRODUCT SUMMARY			
	V _{DS} (V)	r _{DS(on)} (Ω)	I _D (A)
Channel-1	30	0.023 at V _{GS} = 10 V	7.0
		0.032 at V _{GS} = 4.5 V	5.6
Channel-2		0.020 at V _{GS} = 10 V	7.4
		0.027 at V _{GS} = 4.5 V	6.4

SCHOTTKY PRODUCT SUMMARY		
V _{DS} (V)	V _{SD} (V) Diode Forward Voltage	I _F (A)
30	0.40 V at 1.0 A	2.0

FEATURES

- LITTLE FOOT® Plus Integrated Schottky
- 100 % R_g Tested



RoHS
COMPLIANT

APPLICATIONS

- Logic DC/DC
- Notebook PC

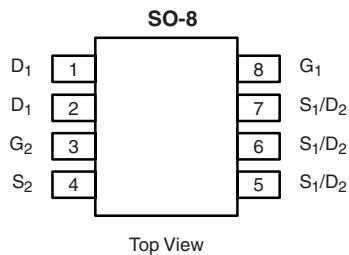

Ordering Information: Si4914DY-T1-E3 (Lead (Pb)-free)

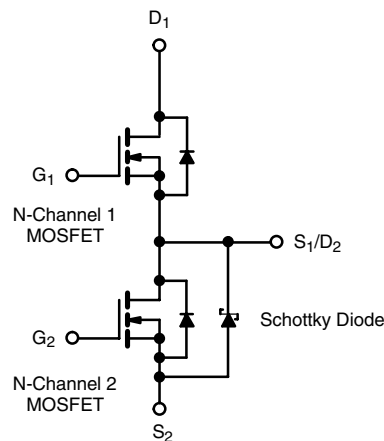

ABSOLUTE MAXIMUM RATINGS T _A = 25 °C, unless otherwise noted							
Parameter	Symbol	Channel-1		Channel-2		Unit	
		10 sec	Steady State	10 sec	Steady State		
Drain-Source Voltage	V _{DS}	30				V	
Gate-Source Voltage	V _{GS}	20					
Continuous Drain Current (T _J = 150 °C) ^a	I _D	T _A = 25 °C	7.0	5.5	7.4	5.7	A
		T _A = 70 °C	5.6	4.3	6	4.5	
Pulsed Drain Current	I _{DM}	40		40		A	
Continuous Source Current (Diode Conduction) ^a	I _S	1.7	1.0	1.8	0.95		
Single Pulse Avalanche Current	I _{AS}	L = 0.1 mH	13		15		mJ
Avalanche Energy			E _{AS}	8.45		11	
Maximum Power Dissipation ^a	P _D	T _A = 25 °C	1.9	1.1	2.0	1.16	W
		T _A = 70 °C	1.2	0.71	1.3	0.74	
Operating Junction and Storage Temperature Range	T _J , T _{stg}	- 55 to 150				°C	

THERMAL RESISTANCE RATINGS							
Parameter	Symbol	Channel-1		Channel-2		Unit	
		Typ	Max	Typ	Max		
Maximum Junction-to-Ambient ^a	R _{thJA}	t ≤ 10 sec	52	65	47	60	°C/W
		Steady State	90	112	85	107	
Maximum Junction-to-Foot (Drain)	R _{thJF}	Steady State	30	38	28	35	

Notes:

a. Surface Mounted on 1" x 1" FR4 Board.

MOSFET SPECIFICATIONS $T_J = 25\text{ }^\circ\text{C}$, unless otherwise noted							
Parameter	Symbol	Test Conditions		Min	Typ ^a	Max	Unit
Static							
Gate Threshold Voltage	$V_{GS(th)}$	$V_{DS} = V_{GS}, I_D = 250\text{ }\mu\text{A}$	Ch-1	1.0		2.5	V
			Ch-2	1.0		2.5	
Gate-Body Leakage	I_{GSS}	$V_{DS} = 0\text{ V}, V_{GS} = 20\text{ V}$	Ch-1			100	nA
			Ch-2			100	
Zero Gate Voltage Drain Current	I_{DSS}	$V_{DS} = 30\text{ V}, V_{GS} = 0\text{ V}$	Ch-1			1	μA
			Ch-2			500	
		$V_{DS} = 30\text{ V}, V_{GS} = 0\text{ V}, T_J = 85\text{ }^\circ\text{C}$	Ch-1			0.015	mA
			Ch-2			20	
On-State Drain Current ^b	$I_{D(on)}$	$V_{DS} = 5\text{ V}, V_{GS} = 10\text{ V}$	Ch-1	20			A
			Ch-2	20			
Drain-Source On-State Resistance ^b	$r_{DS(on)}$	$V_{GS} = 10\text{ V}, I_D = 7.0\text{ A}$	Ch-1		0.019	0.023	Ω
		$V_{GS} = 10\text{ V}, I_D = 7.4\text{ A}$	Ch-2		0.016	0.020	
		$V_{GS} = 4.5\text{ V}, I_D = 5.6\text{ A}$	Ch-1		0.026	0.032	
		$V_{GS} = 4.5\text{ V}, I_D = 6.4\text{ A}$	Ch-2		0.022	0.027	
Forward Transconductance ^b	g_{fs}	$V_{DS} = 15\text{ V}, I_D = 7.0\text{ A}$	Ch-1		19		S
		$V_{DS} = 15\text{ V}, I_D = 7.4\text{ A}$	Ch-2		22		
Diode Forward Voltage ^b	V_{SD}	$I_S = 1.7\text{ A}, V_{GS} = 0\text{ V}$	Ch-1		0.75	1.1	V
		$I_S = 1\text{ A}, V_{GS} = 0\text{ V}$	Ch-2		0.36	0.40	
Dynamic^a							
Total Gate Charge	Q_g	Channel-1 $V_{DS} = 15\text{ V}, V_{GS} = 4.5\text{ V}, I_D = 7.0\text{ A}$	Ch-1		5.6	8.5	nC
			Ch-2		7.3	11	
Gate-Source Charge	Q_{gs}	Channel-2 $V_{DS} = 15\text{ V}, V_{GS} = 4.5\text{ V}, I_D = 7.4\text{ A}$	Ch-1		2.3		
			Ch-2		2.8		
Gate-Drain Charge	Q_{gd}	Channel-2 $V_{DS} = 15\text{ V}, V_{GS} = 4.5\text{ V}, I_D = 7.4\text{ A}$	Ch-1		1.7		
			Ch-2		2.2		
Gate Resistance	R_g		Ch-1	0.5	2.3	3.6	Ω
			Ch-2	0.5	1.6	2.5	
Turn-On Delay Time	$t_{d(on)}$	Channel-1 $V_{DD} = 15\text{ V}, R_L = 15\text{ }\Omega$ $I_D \cong 1\text{ A}, V_{GEN} = 10\text{ V}, R_g = 6\text{ }\Omega$	Ch-1		6	10	ns
			Ch-2		7	11	
Rise Time	t_r	Channel-2 $V_{DD} = 15\text{ V}, R_L = 15\text{ }\Omega$ $I_D \cong 1\text{ A}, V_{GEN} = 10\text{ V}, R_g = 6\text{ }\Omega$	Ch-1		13	20	
			Ch-2		13	20	
Turn-Off Delay Time	$t_{d(off)}$	Channel-1 $V_{DD} = 15\text{ V}, R_L = 15\text{ }\Omega$ $I_D \cong 1\text{ A}, V_{GEN} = 10\text{ V}, R_g = 6\text{ }\Omega$	Ch-1		27	40	
			Ch-2		35	53	
Fall Time	t_f	Channel-2 $V_{DD} = 15\text{ V}, R_L = 15\text{ }\Omega$ $I_D \cong 1\text{ A}, V_{GEN} = 10\text{ V}, R_g = 6\text{ }\Omega$	Ch-1		9	15	
			Ch-2		10	15	
Source-Drain Reverse Recovery Time	t_{rr}	$I_F = 1.3\text{ A}, di/dt = 100\text{ A}/\mu\text{s}$	Ch-1		30	50	
		$I_F = 2.2\text{ A}, di/dt = 100\text{ }\mu\text{A}/\mu\text{s}$	Ch-2		30	50	

Notes:

a. Guaranteed by design, not subject to production testing.

b. Pulse test; pulse width $\leq 300\text{ }\mu\text{s}$, duty cycle $\leq 2\%$.

SCHOTTKY SPECIFICATIONS $T_J = 25\text{ }^\circ\text{C}$, unless otherwise noted							
Parameter	Symbol	Test Conditions		Min	Typ	Max	Unit
Forward Voltage Drop	V_F	$I_F = 1.0\text{ A}$			0.36	0.40	V
		$I_F = 1.0\text{ A}, T_J = 150\text{ }^\circ\text{C}$			0.27	0.31	
Maximum Reverse Leakage Current	I_{rm}	$V_r = 30\text{ V}$			0.008	0.50	mA
		$V_r = 30\text{ V}, T_J = 100\text{ }^\circ\text{C}$			3.5	10	
		$V_r = -30\text{ V}, T_J = 125\text{ }^\circ\text{C}$			10	100	
Junction Capacitance	C_T	$V_r = 10\text{ V}$			58		pF

Stresses beyond those listed under "Absolute Maximum Ratings" may cause permanent damage to the device. These are stress ratings only, and functional operation of the device at these or any other conditions beyond those indicated in the operational sections of the specifications is not implied. Exposure to absolute maximum rating conditions for extended periods may affect device reliability.

CHANNEL-1 TYPICAL CHARACTERISTICS 25 °C, unless noted

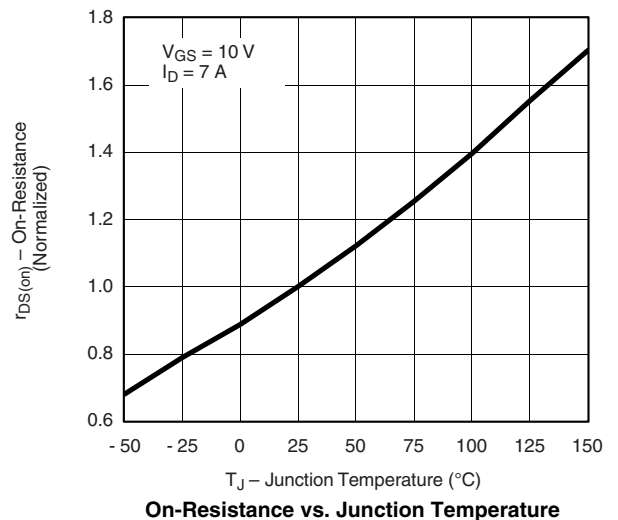
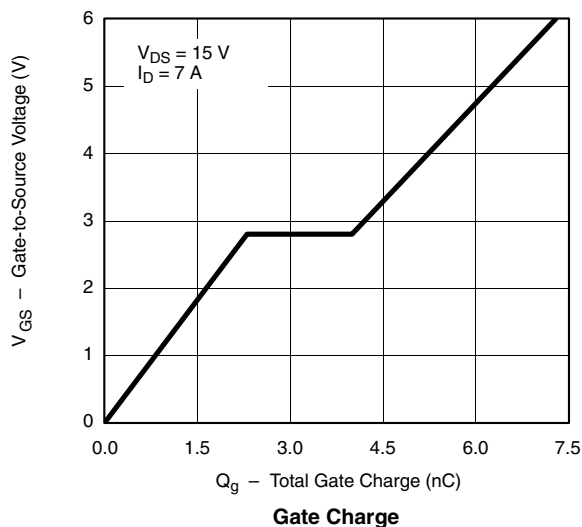
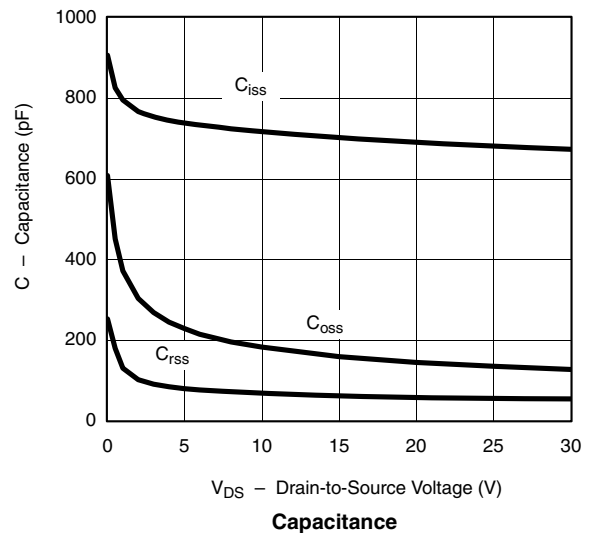
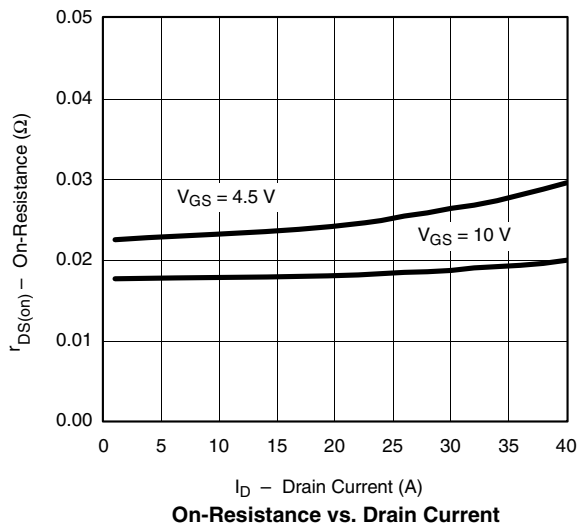
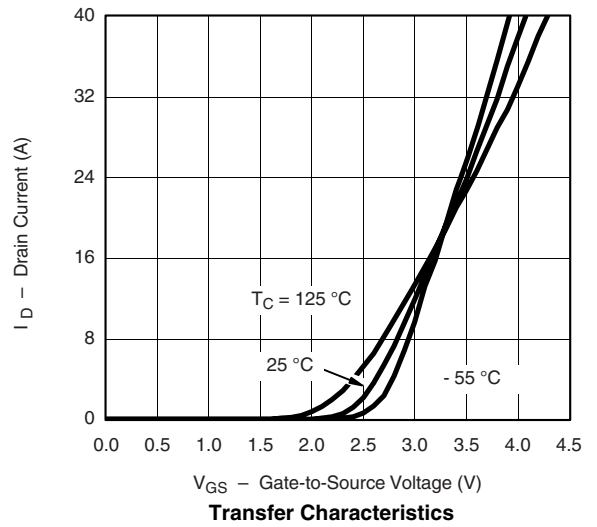
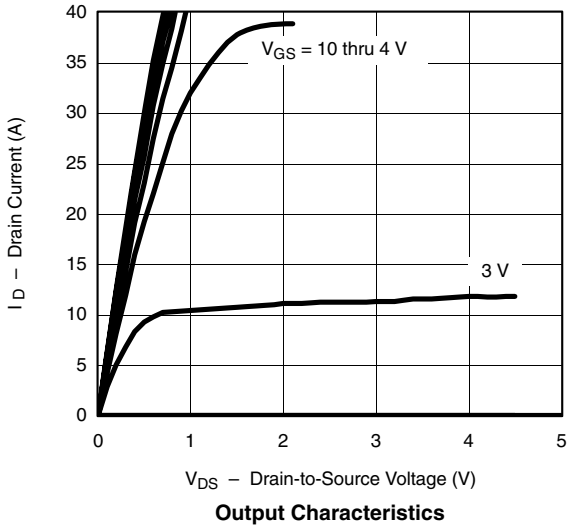

CHANNEL-1 TYPICAL CHARACTERISTICS 25 °C, unless noted

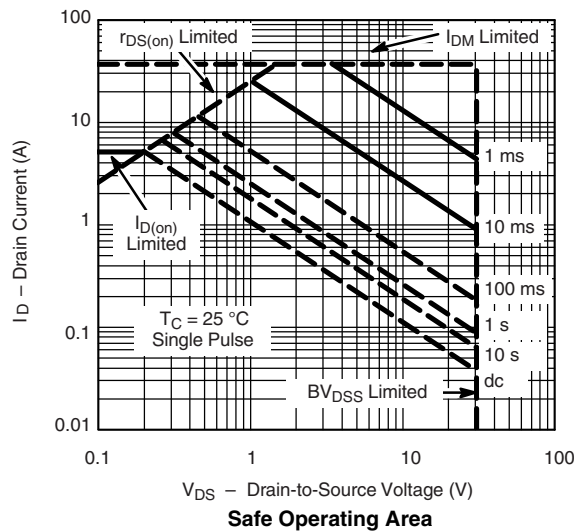
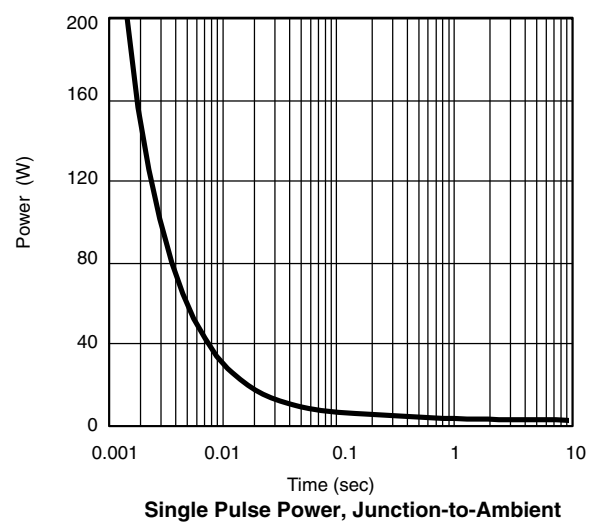
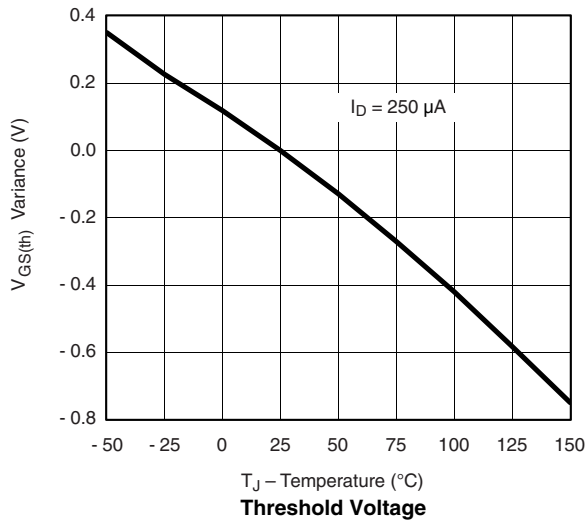
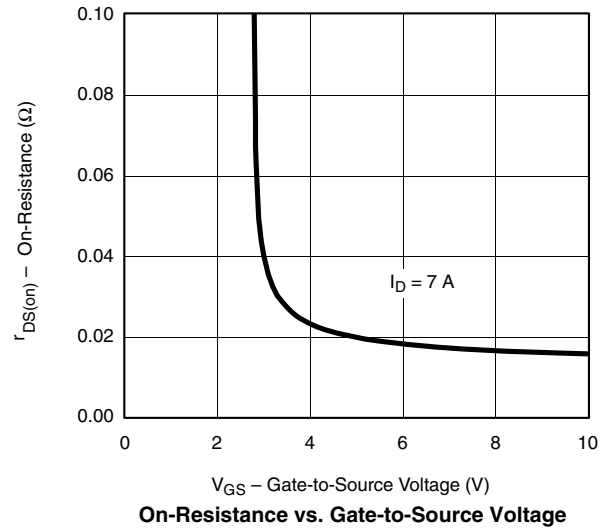
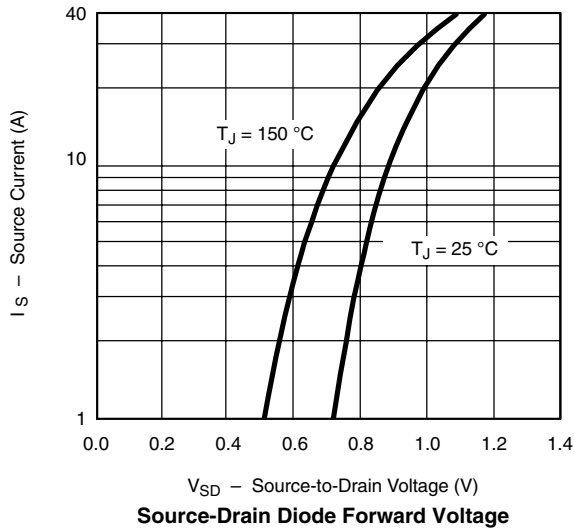

CHANNEL-1 TYPICAL CHARACTERISTICS 25 °C, unless noted

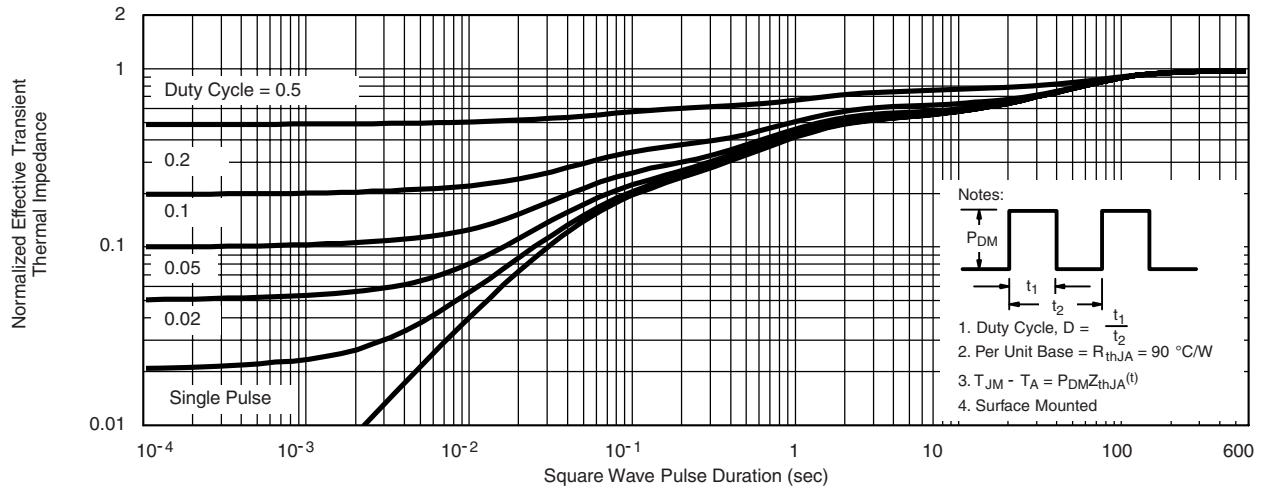

Normalized Thermal Transient Impedance, Junction-to-Ambient

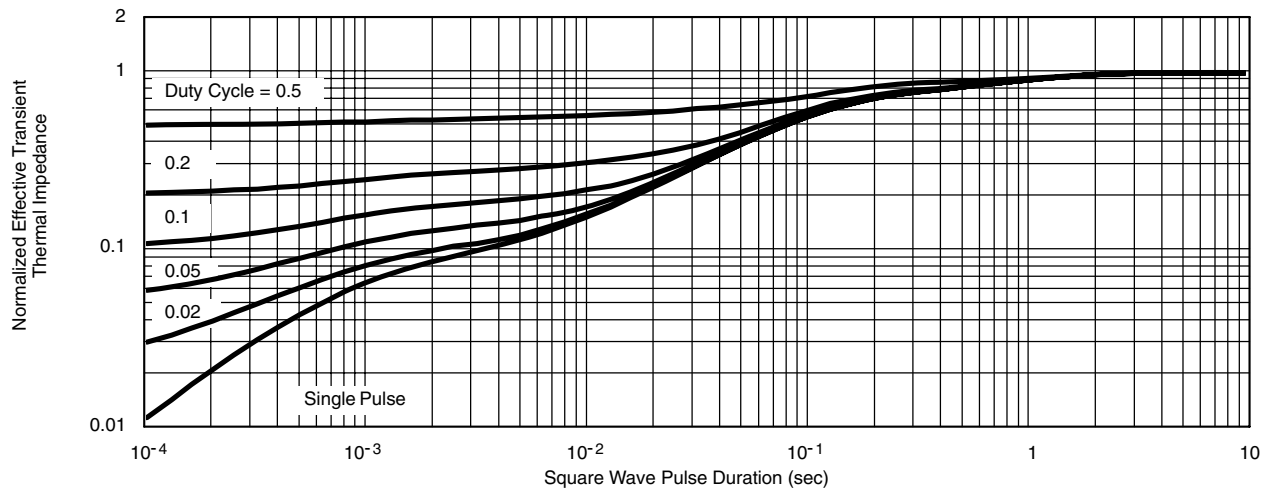

Normalized Thermal Transient Impedance, Junction-to-Foot

CHANNEL-2 TYPICAL CHARACTERISTICS 25 °C, unless noted

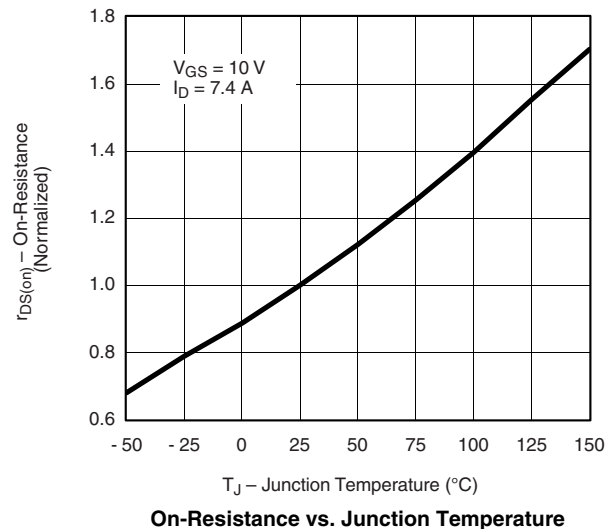
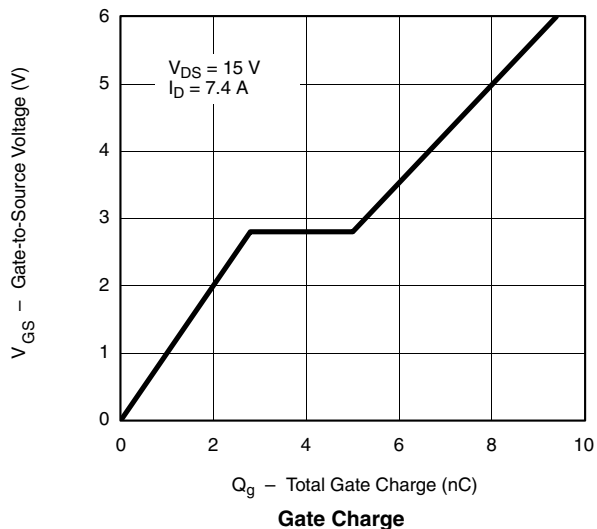
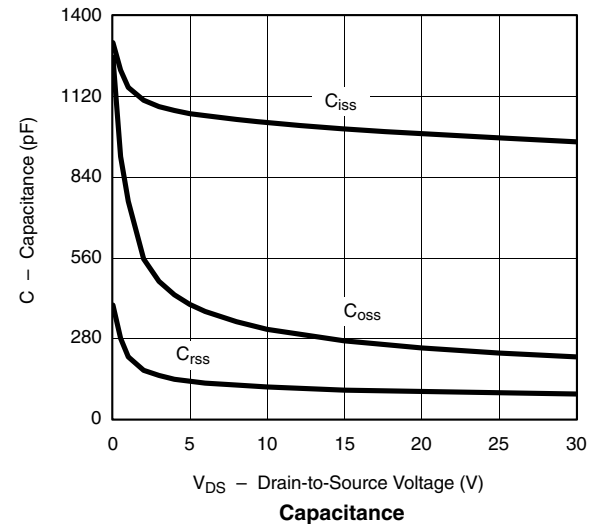
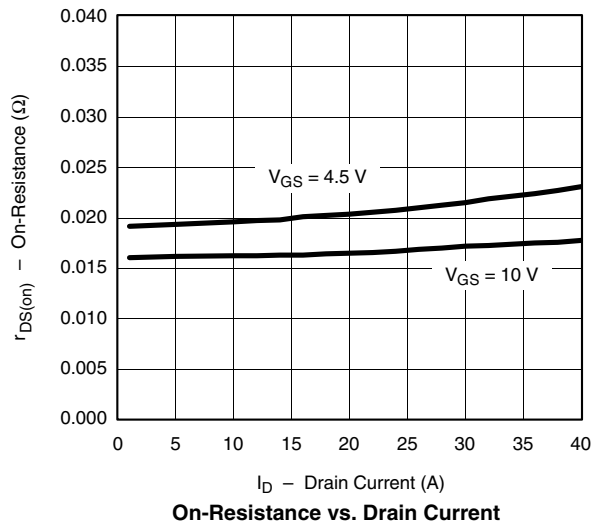
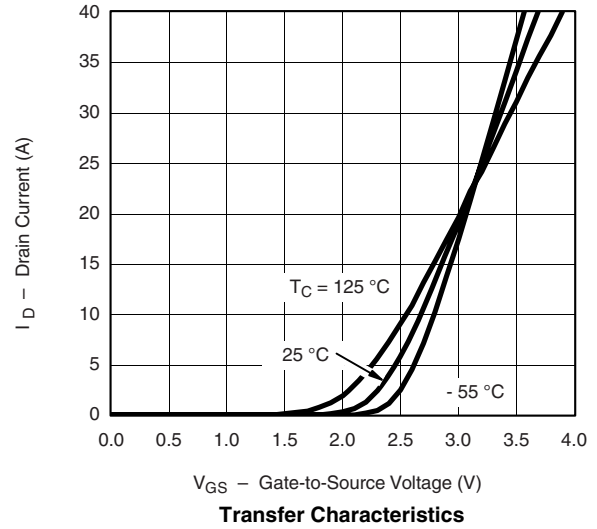
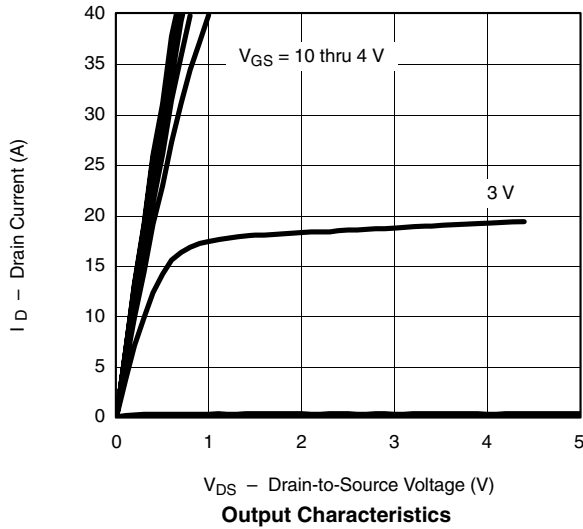

CHANNEL-2 TYPICAL CHARACTERISTICS 25 °C, unless noted

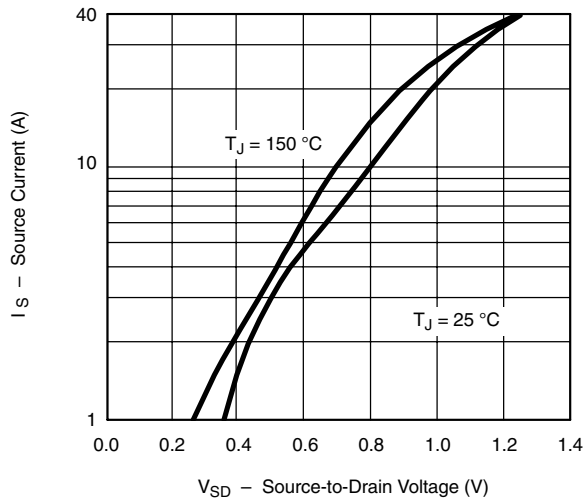

Source-Drain Diode Forward Voltage

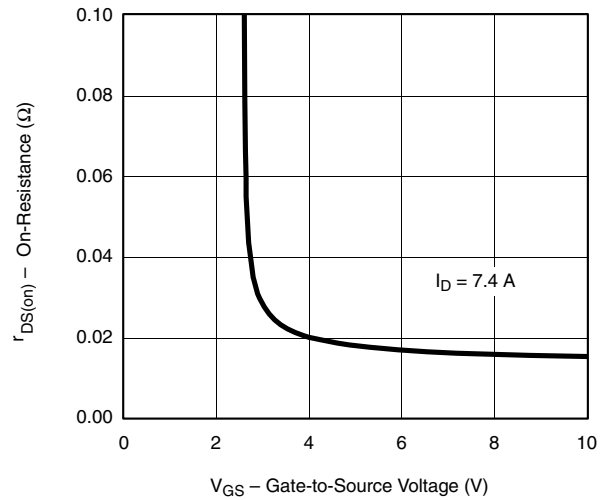

On-Resistance vs. Gate-to-Source Voltage

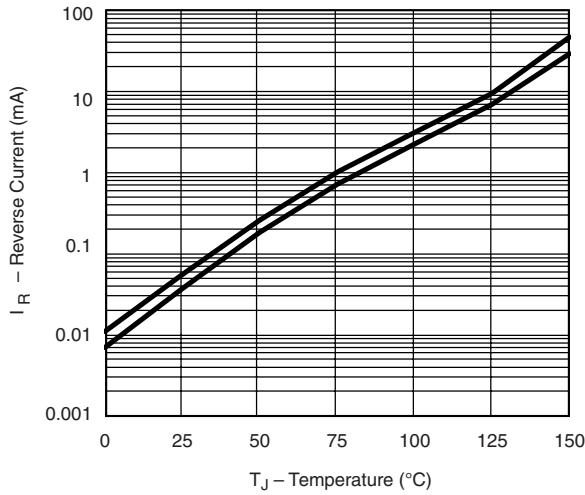

Reverse Current vs. Junction Temperature

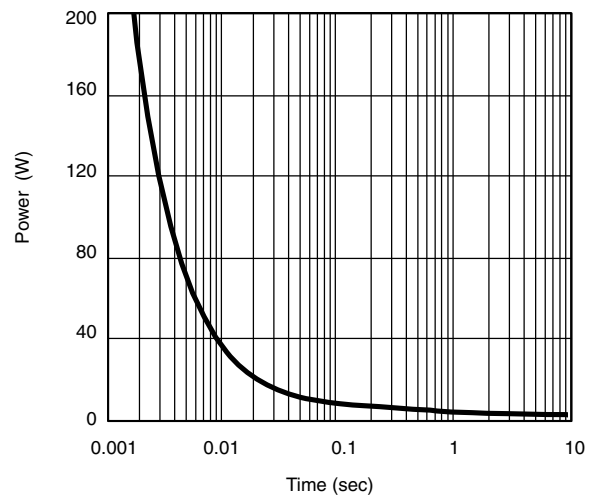

Single Pulse Power, Junction-to-Ambient

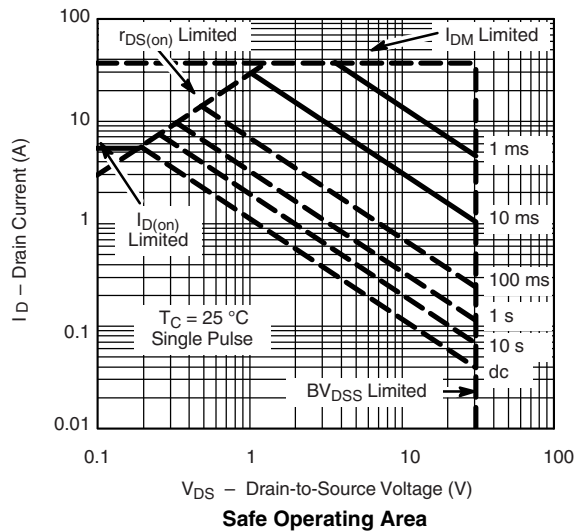

Safe Operating Area

CHANNEL-2 TYPICAL CHARACTERISTICS 25 °C, unless noted

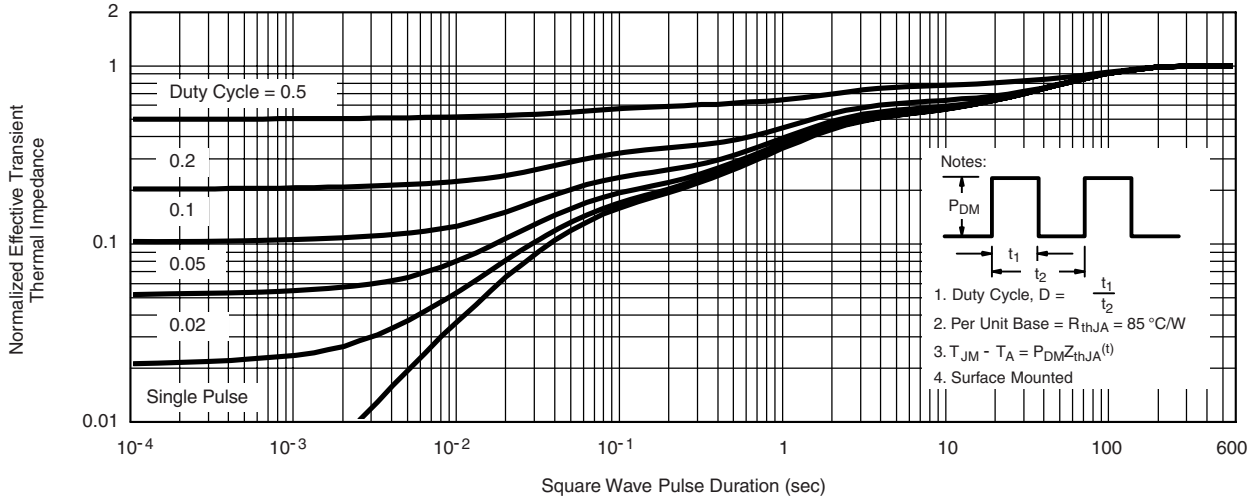

Normalized Thermal Transient Impedance, Junction-to-Ambient

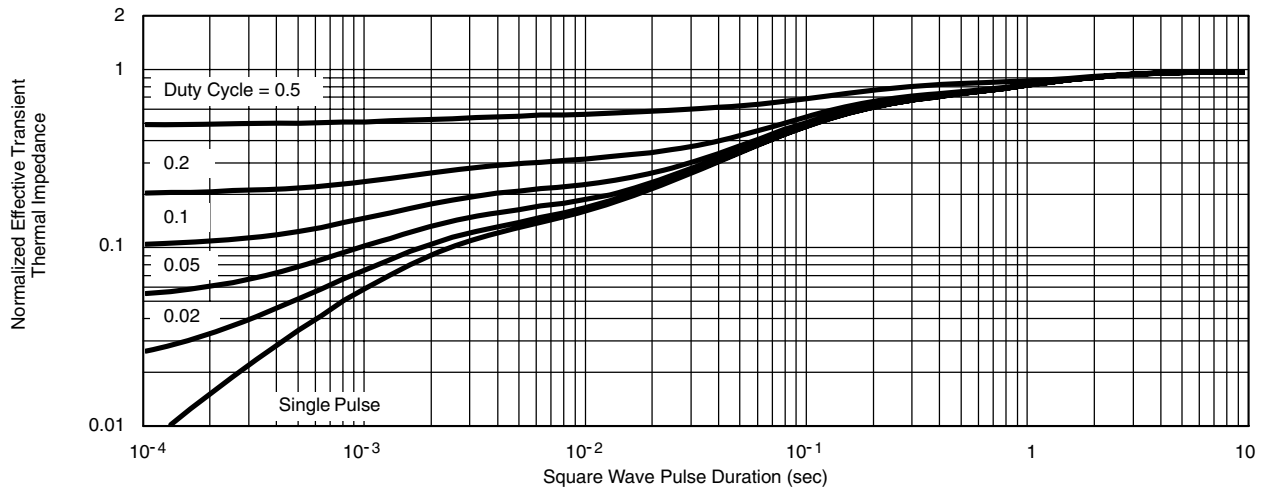

Normalized Thermal Transient Impedance, Junction-to-Foot

Vishay Siliconix maintains worldwide manufacturing capability. Products may be manufactured at one of several qualified locations. Reliability data for Silicon Technology and Package Reliability represent a composite of all qualified locations. For related documents such as package/tape drawings, part marking, and reliability data, see <http://www.vishay.com/ppg?72938>.



Notice

Specifications of the products displayed herein are subject to change without notice. Vishay Intertechnology, Inc., or anyone on its behalf, assumes no responsibility or liability for any errors or inaccuracies.

Information contained herein is intended to provide a product description only. No license, express or implied, by estoppel or otherwise, to any intellectual property rights is granted by this document. Except as provided in Vishay's terms and conditions of sale for such products, Vishay assumes no liability whatsoever, and disclaims any express or implied warranty, relating to sale and/or use of Vishay products including liability or warranties relating to fitness for a particular purpose, merchantability, or infringement of any patent, copyright, or other intellectual property right.

The products shown herein are not designed for use in medical, life-saving, or life-sustaining applications. Customers using or selling these products for use in such applications do so at their own risk and agree to fully indemnify Vishay for any damages resulting from such improper use or sale.