

Low Current Type ($I_F \leq 10\text{mA}$) Mini-molded chip LEDs

SML512 Series

Package Size (mm)	Blue
	InGaN on SiC
	468nm
1608 (0603) 1.6×0.8 t=0.55	
SML512BC4T	

Note) "*" will be taken out for emitting color B series.

Absolute Maximum Ratings ($T_a=25^\circ\text{C}$)

Part No.	Emitting color	Power dissipation P_D (mW)	Forward current I_F (mA)	Peak forward current * I_{FP} (mA)	Reverse voltage V_R (V)	Operating temperature T_{opr} ($^\circ\text{C}$)	Storage temperature T_{stg} ($^\circ\text{C}$)
SML512BC4T	Blue	74	20	100*	5	-30 to +85	-40 to +100

* I_{FP} measured under duty $\leq 1/10, 1\text{kHz}$.

Electrical Optical Characteristics ($T_a=25^\circ\text{C}$)

Part No.	Resin Color	Forward voltage V_F		Reverse current I_R		Light wavelength			Brightness I_v		
		Typ. (V)	I_F (mA)	Max. (μA)	V_R (V)	Peak λ_p (nm)	Half-wave $\Delta\lambda$ (nm)	I_F (mA)	Min. (mcd)	Typ. (mcd)	I_F (mA)
SML512BC4T	Transparent Clear	2.9	5	100	5	468	26	5	5.6	14	5

External Dimensions (Unit : mm)

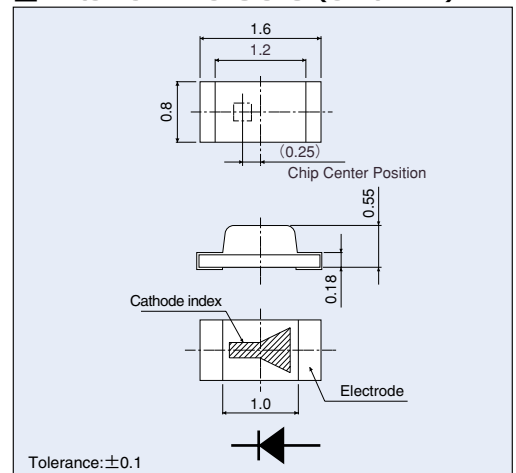

Directivity

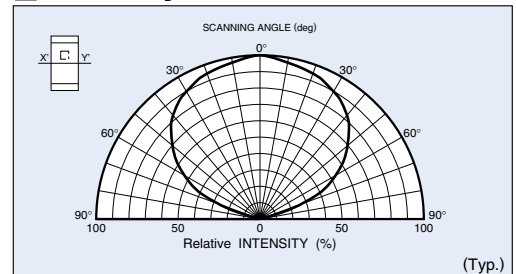

Recommended Pad Layout

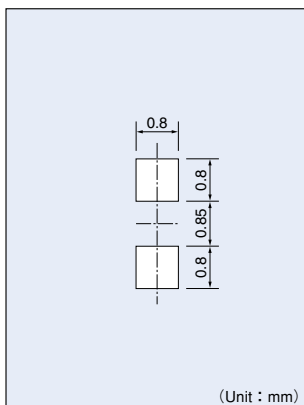

The recommended thickness of the screen mask for soldering is between 100 and 200 μm . The hole size of the screen mask should be same as the recommended land pattern or smaller.

Packaging Specifications (Unit : mm)

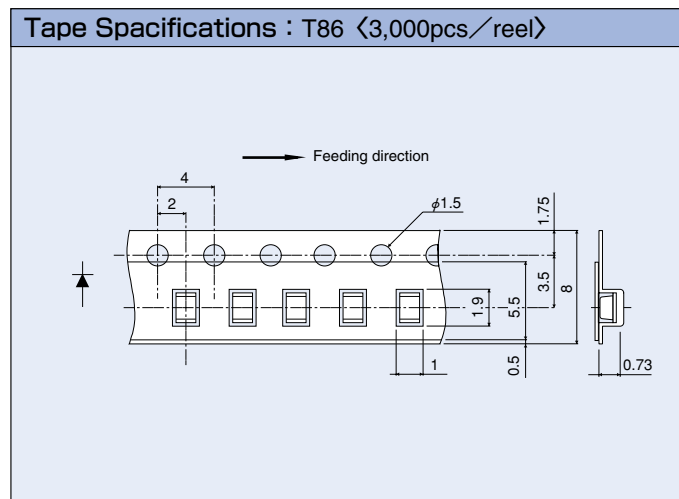

Reel Specifications

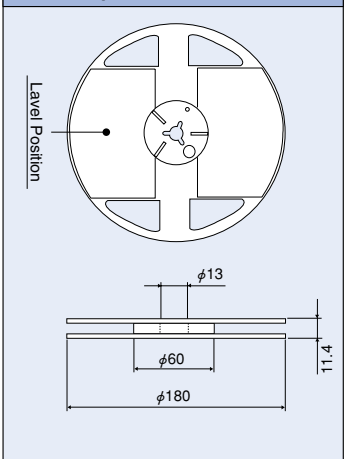

Electrical Characteristic Curves

Forward Current - Forward Voltage

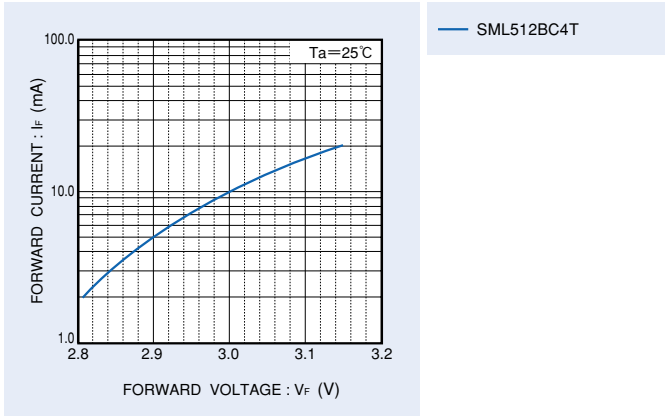

Relative Luminous Intensity - Case Temperature

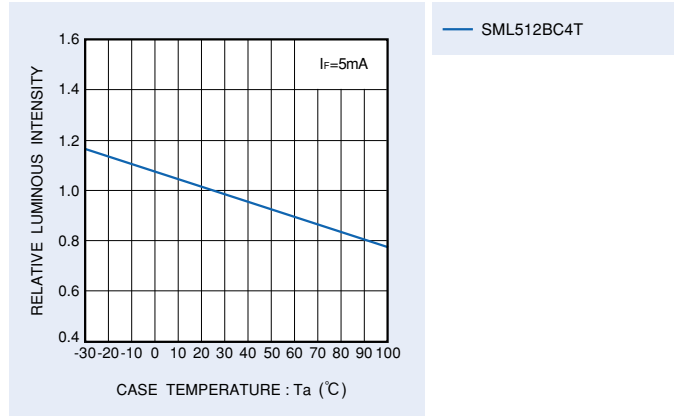

Relative Luminous Intensity - Forward Current

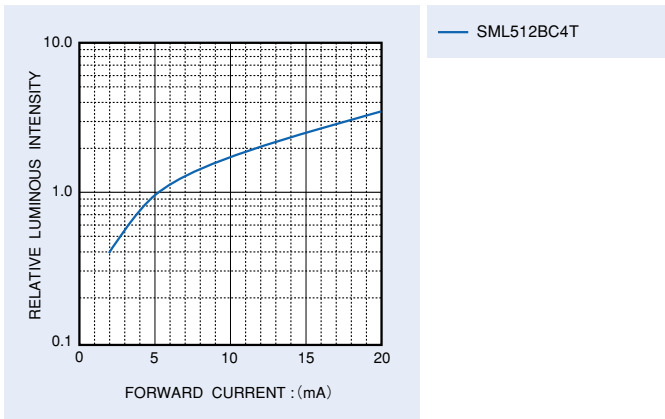

Ratio of Maximum Tolerable Peak Current - Pulse Duration

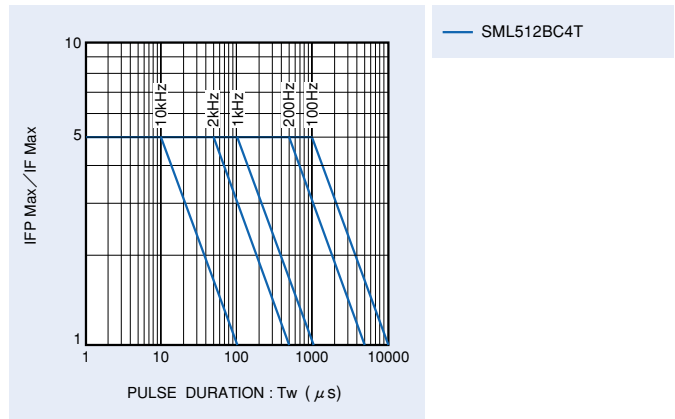

Derating

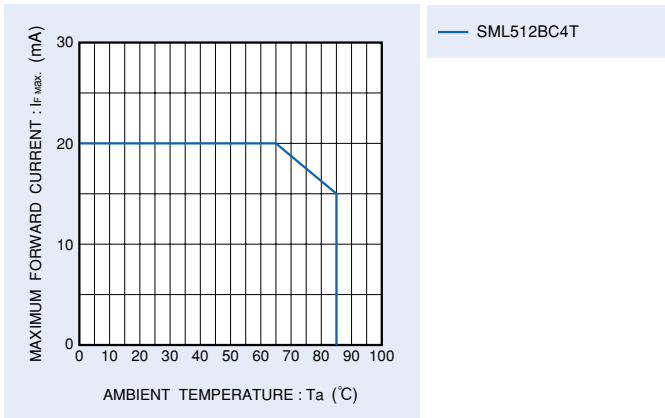

Notes

- No technical content pages of this document may be reproduced in any form or transmitted by any means without prior permission of ROHM CO.,LTD.
- The contents described herein are subject to change without notice. The specifications for the product described in this document are for reference only. Upon actual use, therefore, please request that specifications to be separately delivered.
- Application circuit diagrams and circuit constants contained herein are shown as examples of standard use and operation. Please pay careful attention to the peripheral conditions when designing circuits and deciding upon circuit constants in the set.
- Any data, including, but not limited to application circuit diagrams information, described herein are intended only as illustrations of such devices and not as the specifications for such devices. ROHM CO.,LTD. disclaims any warranty that any use of such devices shall be free from infringement of any third party's intellectual property rights or other proprietary rights, and further, assumes no liability of whatsoever nature in the event of any such infringement, or arising from or connected with or related to the use of such devices.
- Upon the sale of any such devices, other than for buyer's right to use such devices itself, resell or otherwise dispose of the same, no express or implied right or license to practice or commercially exploit any intellectual property rights or other proprietary rights owned or controlled by
- ROHM CO., LTD. is granted to any such buyer.
- Products listed in this document are no antiradiation design.

The products listed in this document are designed to be used with ordinary electronic equipment or devices (such as audio visual equipment, office-automation equipment, communications devices, electrical appliances and electronic toys).

Should you intend to use these products with equipment or devices which require an extremely high level of reliability and the malfunction of which would directly endanger human life (such as medical instruments, transportation equipment, aerospace machinery, nuclear-reactor controllers, fuel controllers and other safety devices), please be sure to consult with our sales representative in advance.

About Export Control Order in Japan

Products described herein are the objects of controlled goods in Annex 1 (Item 16) of Export Trade Control Order in Japan.

In case of export from Japan, please confirm if it applies to "objective" criteria or an "informed" (by MITI clause) on the basis of "catch all controls for Non-Proliferation of Weapons of Mass Destruction.