

Ku Band, 2 Watt Power Amplifier

TGA2510-EPU

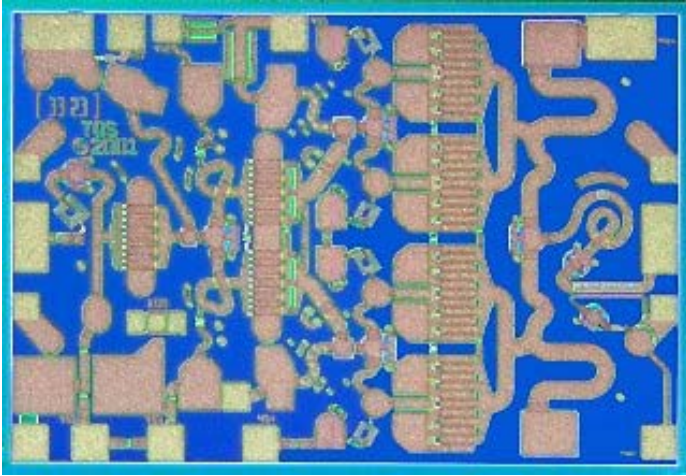

Key Features and Performance

- 34 dBm Midband Psat
- 26 dB Nominal Gain
- 7 dB Typical Input Return Loss
- 12 dB Typical Output Return Loss
- 12.5 - 17 GHz Frequency Range
- Directional Power Detector with Reference
- 0.25µm pHEMT 3MI Technology
- Bias Conditions: 7.5V, 650mA
- Chip Dimensions:
2.02 x 1.38 x 0.10 mm
(0.080 x 0.054 x 0.004 inches)

Preliminary Measured Performance

Bias Conditions: Vd=7.5V Id=650mA

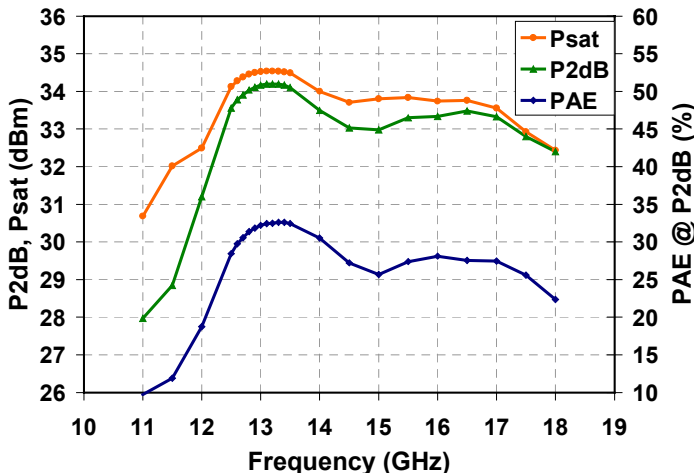
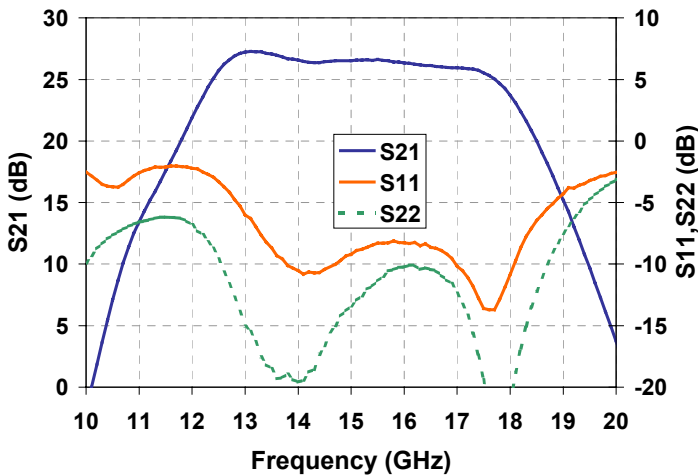

Note: Devices designated as EPU are typically early in their characterization process prior to finalizing all electrical and process specifications. Specifications are subject to change without notice.

Primary Applications

- VSAT
- Point to Point

**TABLE I
MAXIMUM RATINGS**

Symbol	Parameter	Value	Notes
V_D	Drain Voltage	8 V	<u>1/</u> <u>2/</u>
V_G	Gate Voltage Range	-5V to 0V	<u>1/</u>
I_D	Drain Supply Current (Quiescent)	1300 mA	<u>1/</u> <u>2/</u>
$ I_G $	Gate Supply Current	18 mA	<u>1/</u>
P_{IN}	Input Continuous Wave Power	24 dBm	<u>1/</u> <u>2/</u>
P_D	Power Dissipation	6.43 W	<u>1/</u> <u>2/</u> <u>3/</u>
T_{CH}	Operating Channel Temperature	150 °C	<u>4/</u>
T_M	Mounting Temperature (30 Seconds)	320 °C	
T_{STG}	Storage Temperature	-65 to 150 °C	

- 1/ These ratings represent the maximum operable values for this device
- 2/ Combinations of supply voltage, supply current, input power, and output power shall not exceed P_D at a package base temperature of 70°C
- 3/ When operated at this bias condition with a baseplate temperature of 70°C, the MTTF is reduced to 1.0E+6 hours
- 4/ Junction operating temperature will directly affect the device median time to failure (MTTF). For maximum life, it is recommended that junction temperatures be maintained at the lowest possible levels.

**TABLE II
DC PROBE TEST**
($T_A = 25\text{ °C}$, Nominal)

NOTES	SYMBOL	LIMITS		UNITS
		MIN	MAX	
<u>1/</u>	I_{DSS}	80	381	mA
<u>1/</u>	G_M	175	425	mS
<u>2/</u>	$ V_P $	0.5	1.5	V
<u>2/</u>	$ V_{BVGs} $	8	30	V
<u>2/</u>	$ V_{BVGD} $	14	30	V

- 1/ Measurements are performed on a 800µm FET.
- 2/ V_P , V_{BVGD} , and V_{BVGs} are negative.

Note: Devices designated as EPU are typically early in their characterization process prior to finalizing all electrical and process specifications. Specifications are subject to change without notice.

TABLE III
RF CHARACTERIZATION TABLE
($T_A = 25^\circ\text{C}$, Nominal)
($V_d = 7.5\text{V}$, $I_d = 650\text{mA} \pm 5\%$)

Symbol	Parameter	Test Conditions	Typ	Units	Notes
Gain	Small Signal Gain	F = 12.5 – 17 GHz	26	dB	
IRL	Input Return Loss	F = 12.5 – 17 GHz	7	dB	
ORL	Output Return Loss	F = 12.5 – 17 GHz	12	dB	
PWR	Output Power @ Pin = +15dBm	F = 12.5 – 17 GHz	34.0	dBm	
PAE	Power Added Efficiency @ Pin=+15dBm	F = 12.5 – 17 GHz	31	%	

Note: Table III Lists the RF Characteristics of typical devices as determined by fixtured measurements.

TABLE IV
THERMAL INFORMATION

Parameter	Test Conditions	T_{CH} ($^\circ\text{C}$)	$R_{\theta JC}$ ($^\circ\text{C}/\text{W}$)	MTTF (hrs)
$R_{\theta JC}$ Thermal Resistance (Channel to Backside of Carrier)	$V_D = 7.5\text{V}$ $I_D = 650\text{mA}$ $P_{DISS} = 4.88\text{W}$ $T_{BASE} = 70^\circ\text{C}$	130.7	12.44	5.5E+6

Note: Assumes eutectic attach using 1.5mil 80/20 AuSn mounted to a 20mil CuMo carrier at 70°C baseplate temperature. Worst case conditions with no RF applied, 100% of DC power is dissipated.

Note: Devices designated as EPU are typically early in their characterization process prior to finalizing all electrical and process specifications. Specifications are subject to change without notice.

Typical Fixtured Performance

$I_d=650\text{mA}$

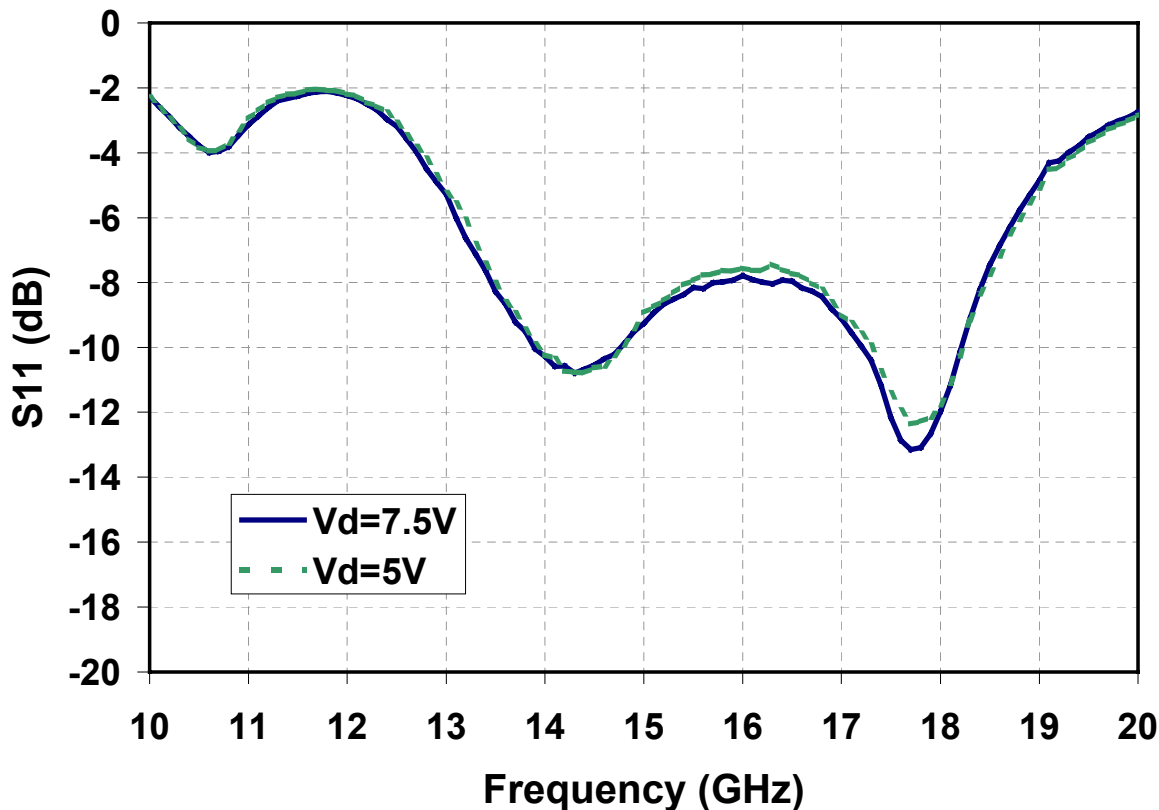
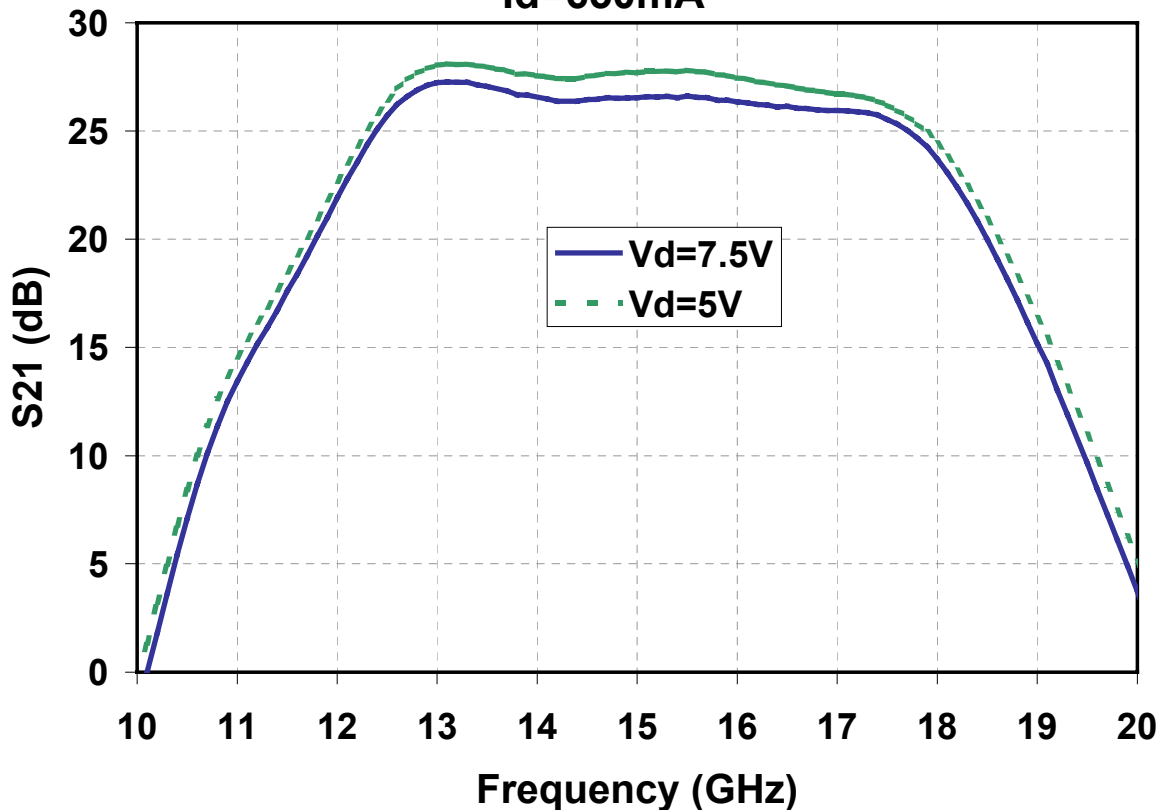

Note: Devices designated as EPU are typically early in their characterization process prior to finalizing all electrical and process specifications. Specifications are subject to change without notice.

Typical Fixtured Performance

TGA2510-EPU

$I_d=650\text{mA}$

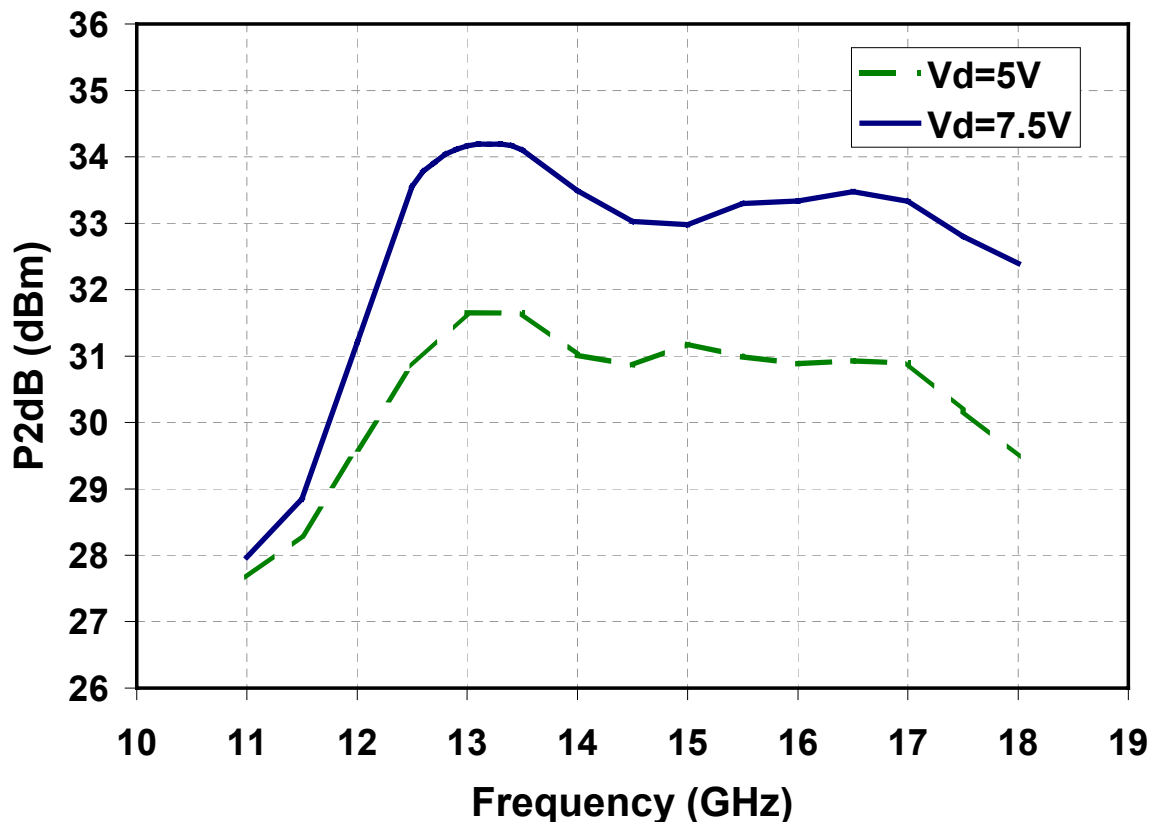
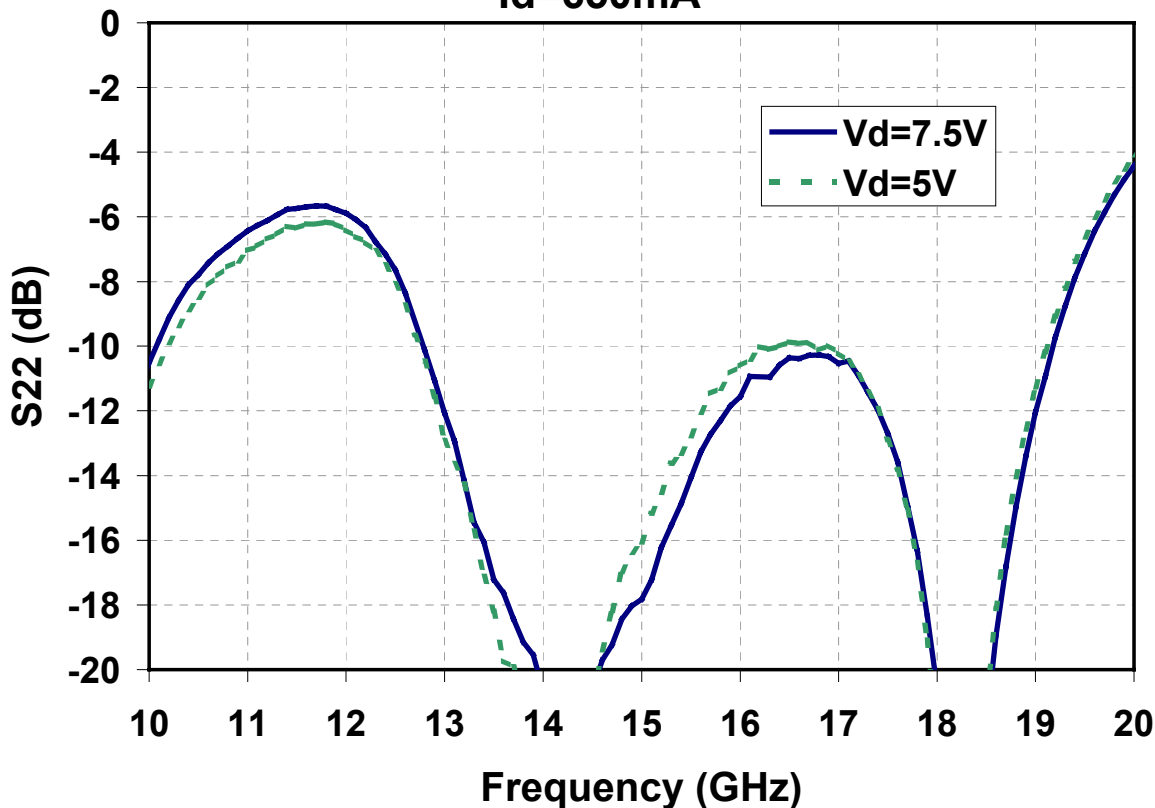

Note: Devices designated as EPU are typically early in their characterization process prior to finalizing all electrical and process specifications. Specifications are subject to change without notice.

Typical Fixtured Performance

TGA2510-EPU

$I_d=650mA$

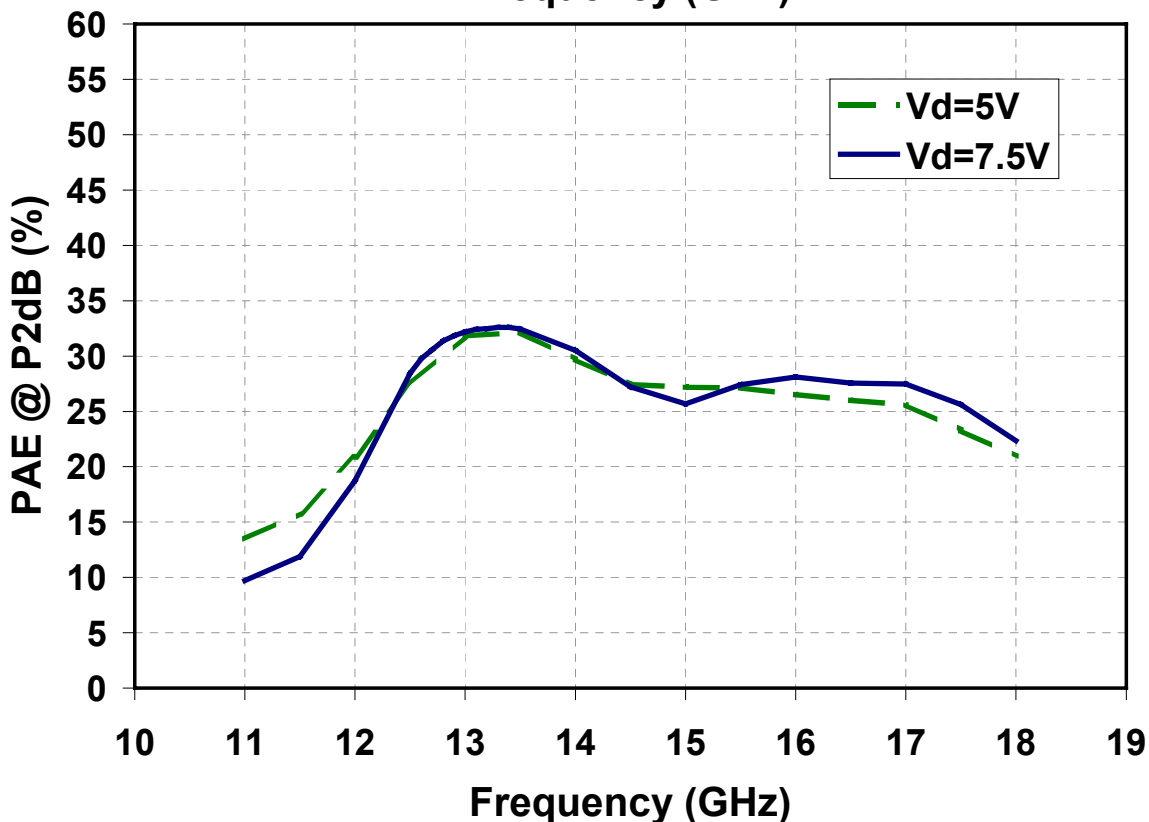
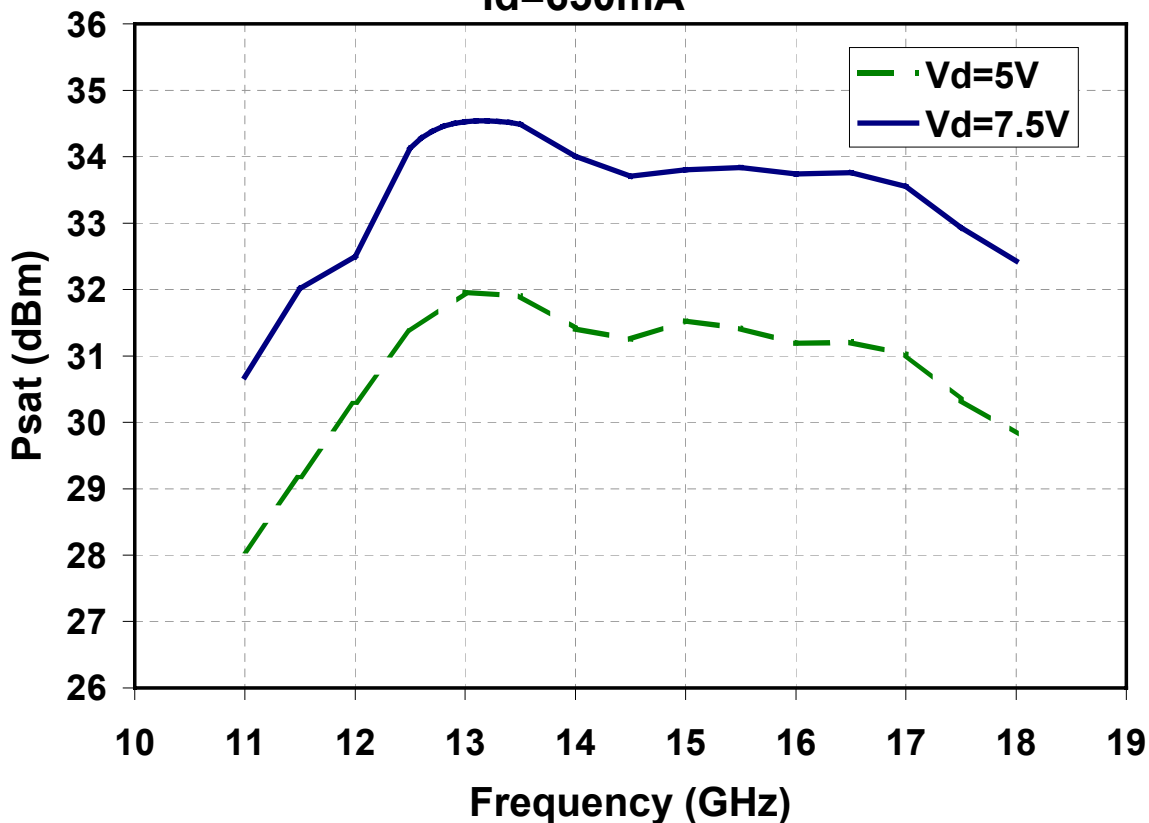

Note: Devices designated as EPU are typically early in their characterization process prior to finalizing all electrical and process specifications. Specifications are subject to change without notice.

Typical Fixtured Performance

TGA2510-EPU

$I_d=650\text{mA}$

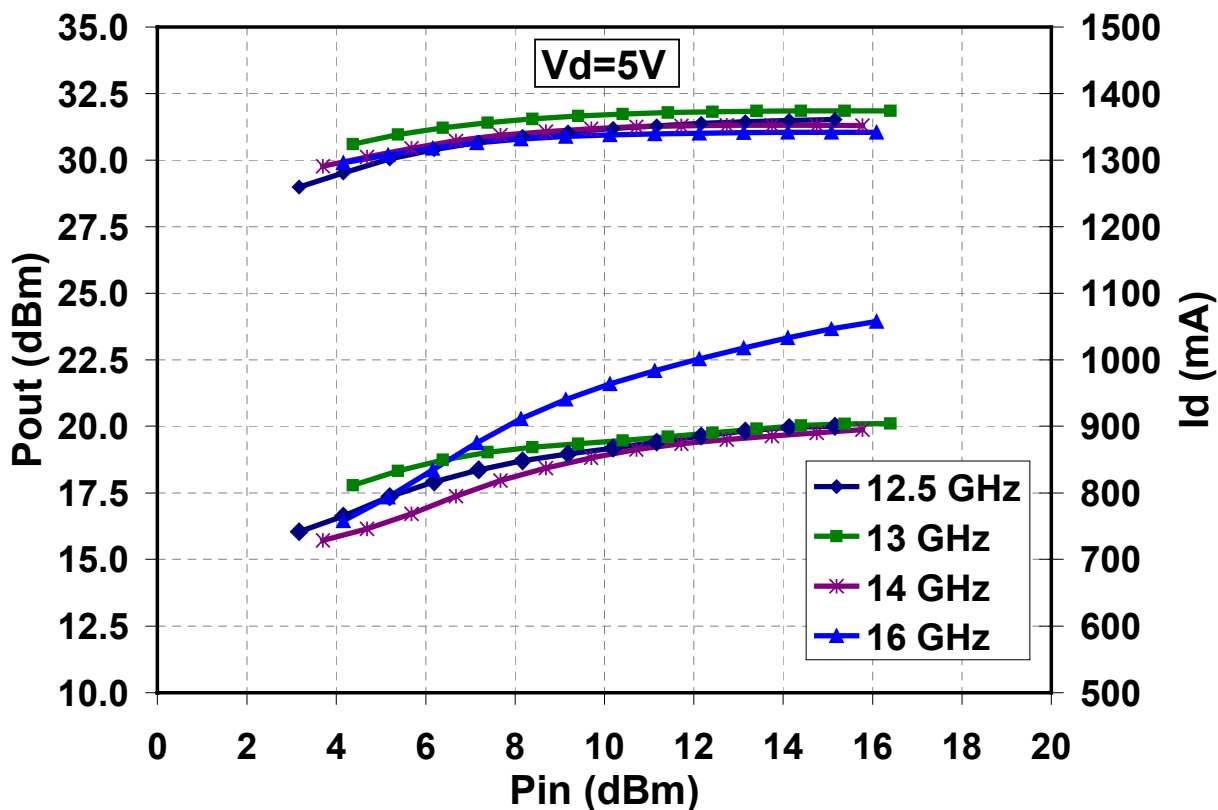
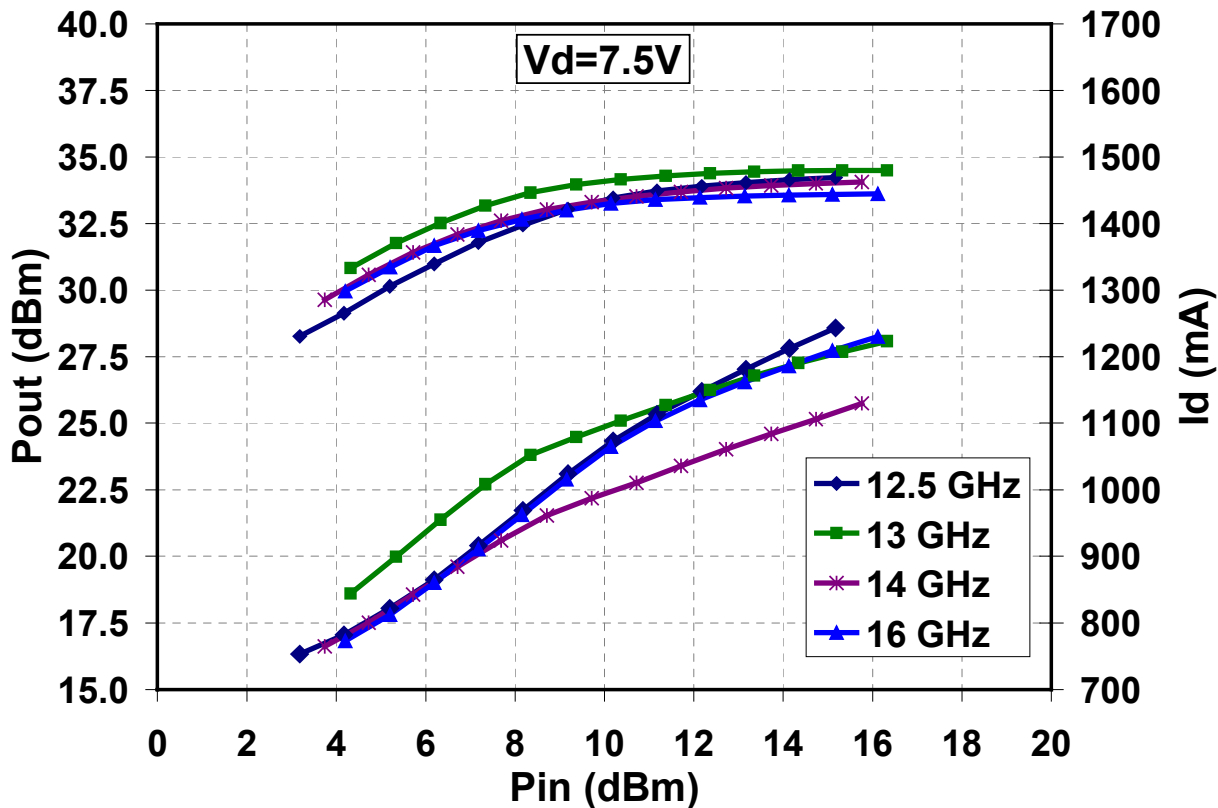

Note: Devices designated as EPU are typically early in their characterization process prior to finalizing all electrical and process specifications. Specifications are subject to change without notice.

Mechanical Drawing

TGA2510-EPU

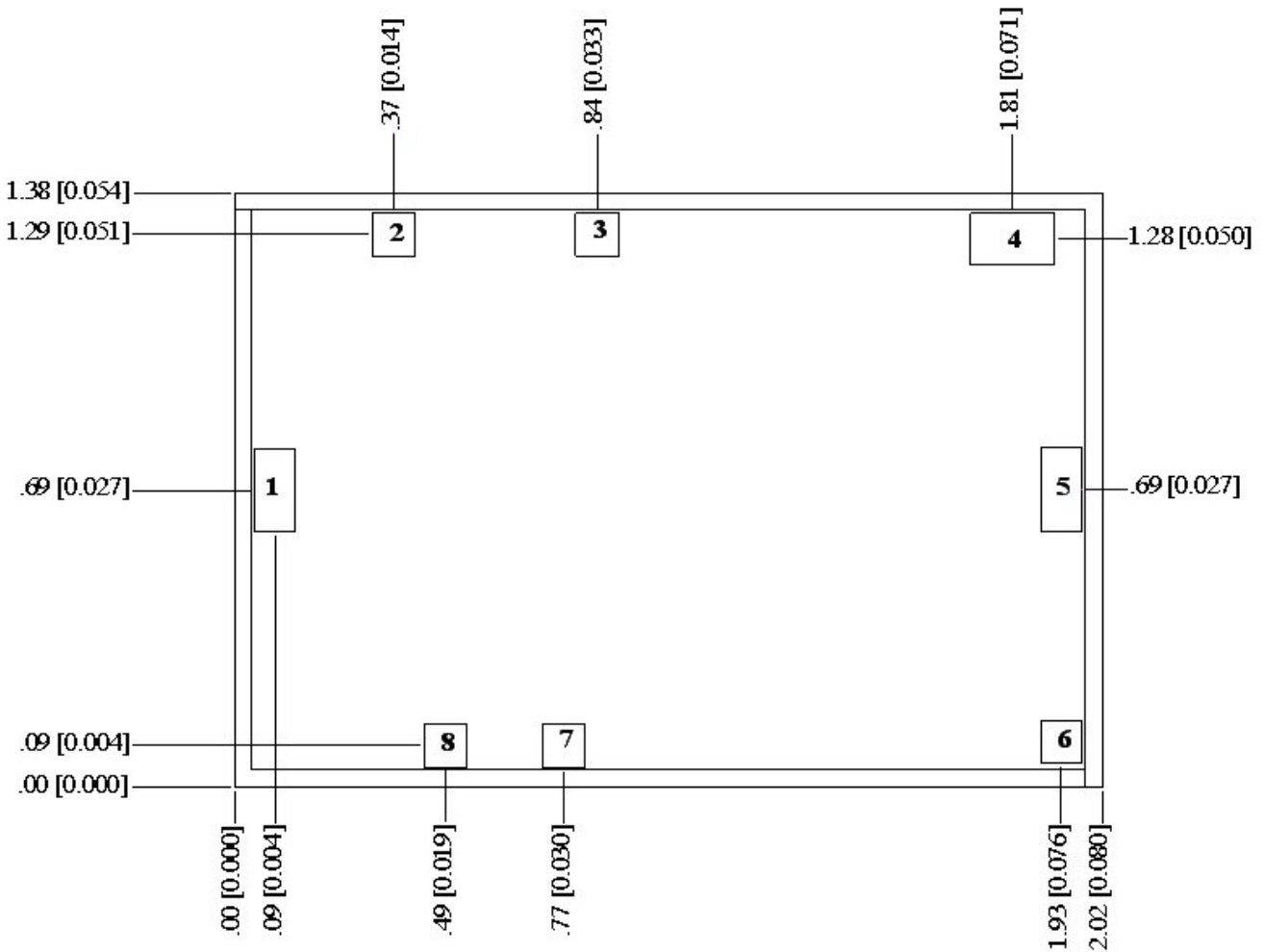

Units: millimeters [inches]

Thickness: 0.10 [0.004] (reference only)

Chip edge to bond pad dimensions are shown to center of bond pads.

Chip size tolerance: ± 0.05 [0.002]

RF groundthrough backside

BondPad#1	RF Input	0.10 x 0.20	[0.004 x 0.008]
BondPad#2	Vref	0.10 x 0.10	[0.004 x 0.004]
BondPad#3	Vd3	0.10 x 0.20	[0.004 x 0.008]
BondPad#4	Vd4	0.20 x 0.13	[0.008 x 0.005]
BondPad#5	RF Output	0.10 x 0.20	[0.004 x 0.008]
BondPad#6	Vdet	0.10 x 0.10	[0.004 x 0.004]
BondPad#7	Vg4	0.10 x 0.10	[0.004 x 0.004]
BondPad#8	Vg3	0.10 x 0.10	[0.004 x 0.004]

Note: Devices designated as EPU are typically early in their characterization process prior to finalizing all electrical and process specifications. Specifications are subject to change without notice.

Power Detector

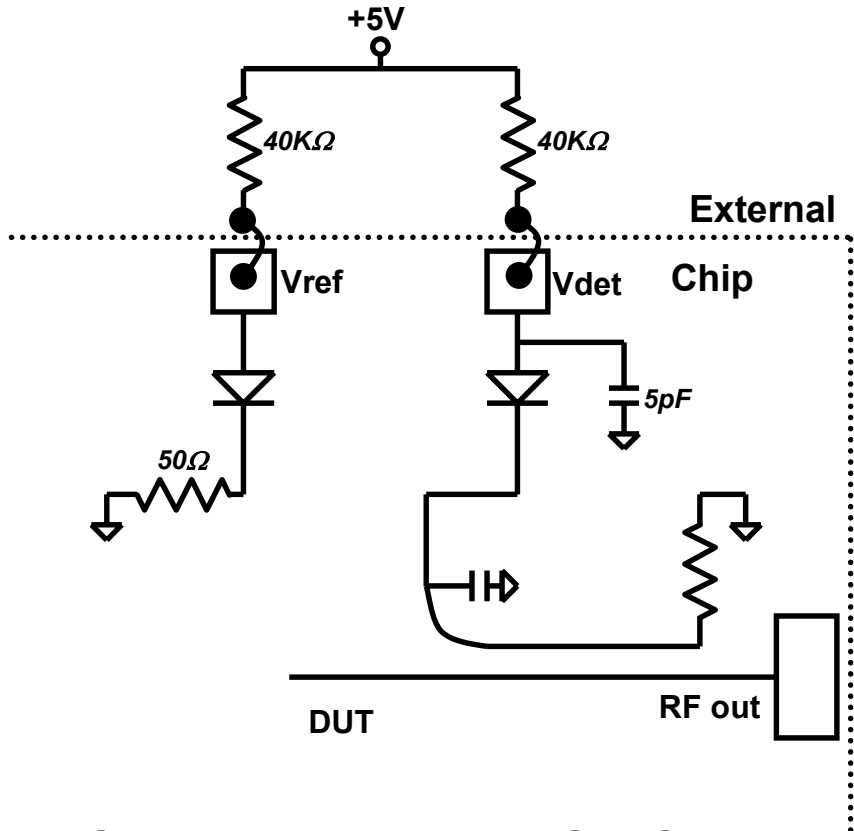

TGA2510 Power Detector @ 14GHz

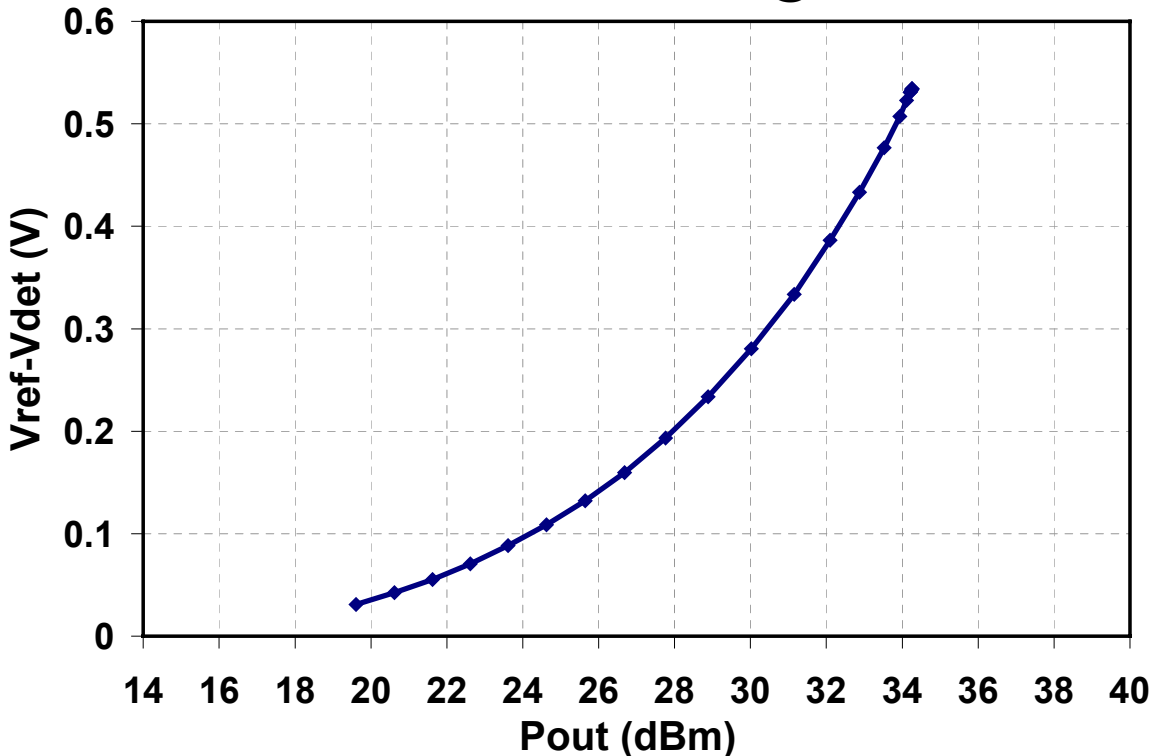

Note: Devices designated as EPU are typically early in their characterization process prior to finalizing all electrical and process specifications. Specifications are subject to change without notice.

Chip Assembly & Bonding Diagram

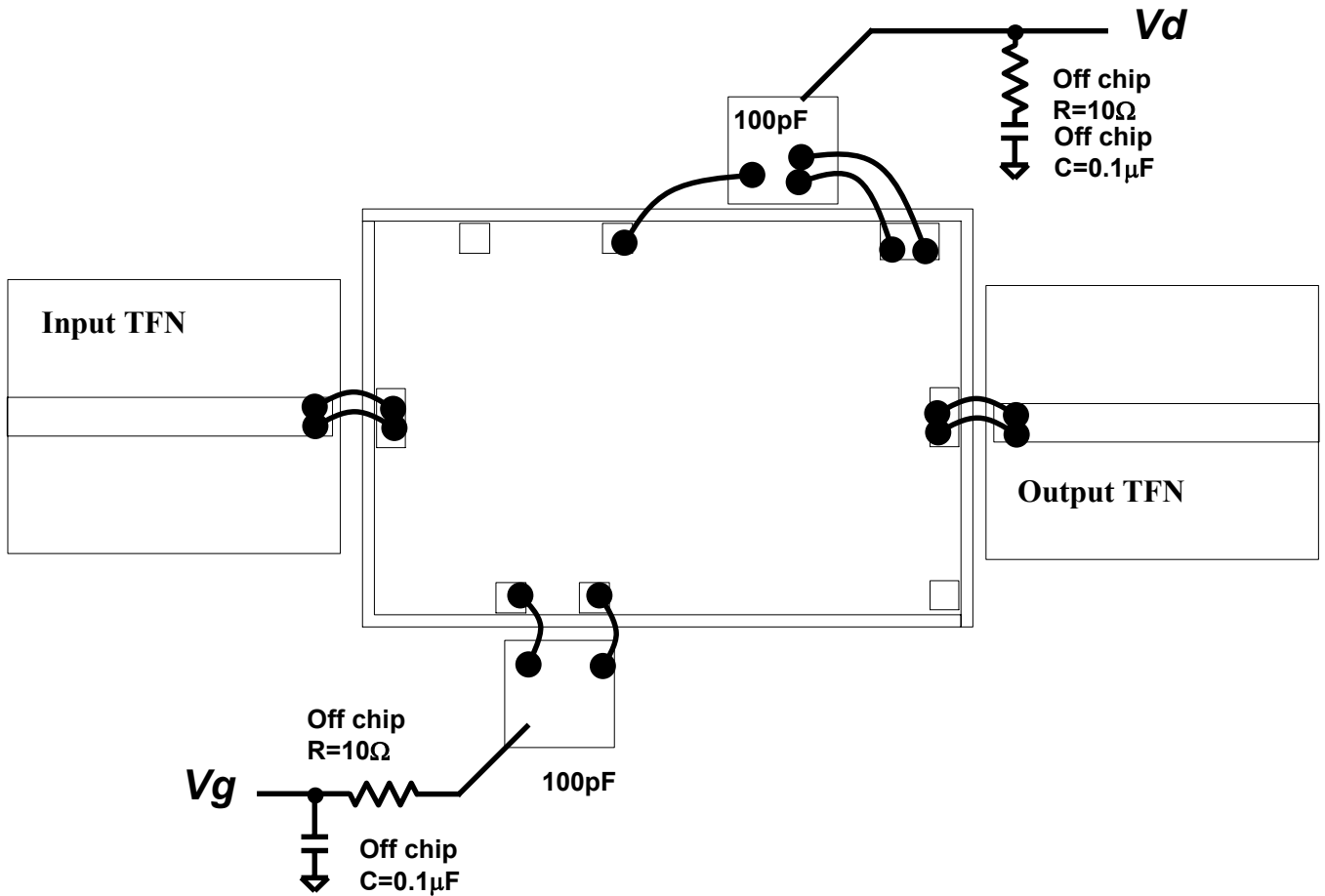

GaAs MMIC devices are susceptible to damage from Electrostatic Discharge. Proper precautions should be observed during handling, assembly and test.

Note: Devices designated as EPU are typically early in their characterization process prior to finalizing all electrical and process specifications. Specifications are subject to change without notice.

Assembly Process Notes

Reflow process assembly notes:

- Use AuSn (80/20) solder with limited exposure to temperatures at or above 300°C. (30 seconds maximum)
- An alloy station or conveyor furnace with reducing atmosphere should be used.
- No fluxes should be utilized.
- Coefficient of thermal expansion matching is critical for long-term reliability.
- Devices must be stored in a dry nitrogen atmosphere.

Component placement and adhesive attachment assembly notes:

- Vacuum pencils and/or vacuum collets are the preferred method of pick up.
- Air bridges must be avoided during placement.
- The force impact is critical during auto placement.
- Organic attachment can be used in low-power applications.
- Curing should be done in a convection oven; proper exhaust is a safety concern.
- Microwave or radiant curing should not be used because of differential heating.
- Coefficient of thermal expansion matching is critical.

Interconnect process assembly notes:

- Thermosonic ball bonding is the preferred interconnect technique.
- Force, time, and ultrasonics are critical parameters.
- Aluminum wire should not be used.
- Maximum stage temperature is 200°C.

GaAs MMIC devices are susceptible to damage from Electrostatic Discharge. Proper precautions should be observed during handling, assembly and test.

Note: Devices designated as EPU are typically early in their characterization process prior to finalizing all electrical and process specifications. Specifications are subject to change without notice.