

## High Efficiency LED in $\varnothing$ 3 mm Tinted Diffused Package

Color	Type	Technology	Angle of Half Intensity $\pm\varphi$
High efficiency red	TLHR44..	GaAsP on GaP	30°
Soft orange	TLHO44..	GaAsP on GaP	30°
Yellow	TLHY44..	GaAsP on GaP	30°
Green	TLHG44..	GaP on GaP	30°
Pure green	TLHP44..	GaP on GaP	30°

### Description

The TLH.44.. series was developed for standard applications like general indicating and lighting purposes.

It is housed in a 3 mm tinted diffused plastic package. The wide viewing angle of these devices provides a high on-off contrast.

Several selection types with different luminous intensities are offered. All LEDs are categorized in luminous intensity groups. The green and yellow LEDs are categorized additionally in wavelength groups.

That allows users to assemble LEDs with uniform appearance.

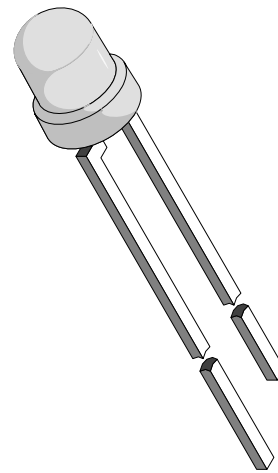

94 8488

### Features

- Standard T-1 package
- Small mechanical tolerances
- Suitable for DC and high peak current
- Wide viewing angle
- Luminous intensity categorized
- Yellow and green color categorized

### Applications

Status lights  
 OFF / ON indicator  
 Background illumination  
 Readout lights  
 Maintenance lights  
 Legend light

### Absolute Maximum Ratings

$T_{amb} = 25^{\circ}\text{C}$ , unless otherwise specified

TLHR44.., TLHO44.., TLHY44.., TLHG44.., TLHP44..

Parameter	Test Conditions	Symbol	Value	Unit
Reverse voltage		$V_R$	6	V
DC forward current		$I_F$	30	mA
Surge forward current	$t_p \leq 10 \mu\text{s}$	$I_{FSM}$	1	A
Power dissipation	$T_{amb} \leq 60^{\circ}\text{C}$	$P_V$	100	mW
Junction temperature		$T_j$	100	$^{\circ}\text{C}$
Operating temperature range		$T_{amb}$	-20 to +100	$^{\circ}\text{C}$
Storage temperature range		$T_{stg}$	-55 to +100	$^{\circ}\text{C}$
Soldering temperature	$t \leq 5 \text{ s}$ , 2 mm from body	$T_{sd}$	260	$^{\circ}\text{C}$
Thermal resistance junction/ambient		$R_{thJA}$	400	K/W

### Optical and Electrical Characteristics

$T_{amb} = 25^{\circ}\text{C}$ , unless otherwise specified

High efficiency red (TLHR44..)

Parameter	Test Conditions	Type	Symbol	Min	Typ	Max	Unit
Luminous intensity	$I_F = 10 \text{ mA}$ , $I_{Vmin}/I_{Vmax} \geq 0.5$	TLHR4400	$I_V$	1.6	3		mcd
		TLHR4401	$I_V$	2.5	5		mcd
		TLHR4405	$I_V$	6.3	10		mcd
Dominant wavelength	$I_F = 10 \text{ mA}$		$\lambda_d$	612		625	nm
Peak wavelength	$I_F = 10 \text{ mA}$		$\lambda_p$		635		nm
Angle of half intensity	$I_F = 10 \text{ mA}$		$\phi$		$\pm 30$		deg
Forward voltage	$I_F = 20 \text{ mA}$		$V_F$		2	3	V
Reverse voltage	$I_R = 10 \mu\text{A}$		$V_R$	6	15		V
Junction capacitance	$V_R = 0$ , $f = 1 \text{ MHz}$		$C_j$		50		pF

Soft orange (TLHO44..)

Parameter	Test Conditions	Type	Symbol	Min	Typ	Max	Unit
Luminous intensity	$I_F = 10 \text{ mA}$ , $I_{Vmin}/I_{Vmax} \geq 0.5$		$I_V$	1.6	4		mcd
Dominant wavelength	$I_F = 10 \text{ mA}$	TLHO4400	$\lambda_d$	598		611	nm
Peak wavelength	$I_F = 10 \text{ mA}$		$\lambda_p$		605		nm
Angle of half intensity	$I_F = 10 \text{ mA}$		$\phi$		$\pm 30$		deg
Forward voltage	$I_F = 20 \text{ mA}$		$V_F$		2.4	3	V
Reverse voltage	$I_R = 10 \mu\text{A}$		$V_R$	6	15		V
Junction capacitance	$V_R = 0$ , $f = 1 \text{ MHz}$		$C_j$		15		pF



**Yellow (TLHY44..)**

Parameter	Test Conditions	Type	Symbol	Min	Typ	Max	Unit
Luminous intensity	$I_F = 10 \text{ mA}$ , $I_{Vmin}/I_{Vmax} \geq 0.5$	TLHY4400	$I_V$	1.6	3		mcd
		TLHY4401	$I_V$	2.5	5		mcd
		TLHY4405	$I_V$	6.3	10		mcd
Dominant wavelength	$I_F = 10 \text{ mA}$		$\lambda_d$	581		594	nm
Peak wavelength	$I_F = 10 \text{ mA}$		$\lambda_p$		585		nm
Angle of half intensity	$I_F = 10 \text{ mA}$		$\phi$		$\pm 30$		deg
Forward voltage	$I_F = 20 \text{ mA}$		$V_F$		2.4	3	V
Reverse voltage	$I_R = 10 \text{ }\mu\text{A}$		$V_R$	6	15		V
Junction capacitance	$V_R = 0$ , $f = 1 \text{ MHz}$		$C_j$		50		pF

**Green (TLHG44..)**

Parameter	Test Conditions	Type	Symbol	Min	Typ	Max	Unit
Luminous intensity	$I_F = 10 \text{ mA}$ , $I_{Vmin}/I_{Vmax} \geq 0.5$	TLHG4400	$I_V$	2.5	4		mcd
		TLHG4401	$I_V$	4	6		mcd
		TLHG4405	$I_V$	6.3	12		mcd
Dominant wavelength	$I_F = 10 \text{ mA}$		$\lambda_d$	562		575	nm
Peak wavelength	$I_F = 10 \text{ mA}$		$\lambda_p$		565		nm
Angle of half intensity	$I_F = 10 \text{ mA}$		$\phi$		$\pm 30$		deg
Forward voltage	$I_F = 20 \text{ mA}$		$V_F$		2.4	3	V
Reverse voltage	$I_R = 10 \text{ }\mu\text{A}$		$V_R$	6	15		V
Junction capacitance	$V_R = 0$ , $f = 1 \text{ MHz}$		$C_j$		50		pF

**Pure green (TLHP44..)**

Parameter	Test Conditions	Type	Symbol	Min	Typ	Max	Unit
Luminous intensity	$I_F = 10 \text{ mA}$ , $I_{Vmin}/I_{Vmax} \geq 0.5$	TLHP4400	$I_V$	0.63	2		mcd
		TLHP4401	$I_V$	1	3		mcd
		TLHP4405	$I_V$	1.6	3.5		mcd
Dominant wavelength	$I_F = 10 \text{ mA}$		$\lambda_d$	555		565	nm
Peak wavelength	$I_F = 10 \text{ mA}$		$\lambda_p$		555		nm
Angle of half intensity	$I_F = 10 \text{ mA}$		$\phi$		$\pm 30$		deg
Forward voltage	$I_F = 20 \text{ mA}$		$V_F$		2.4	3	V
Reverse voltage	$I_R = 10 \text{ }\mu\text{A}$		$V_R$	6	15		V
Junction capacitance	$V_R = 0$ , $f = 1 \text{ MHz}$		$C_j$		50		pF



Typical Characteristics ( $T_{amb} = 25^{\circ}\text{C}$ , unless otherwise specified)

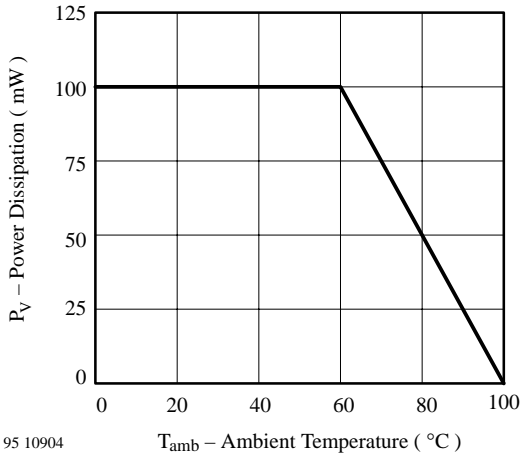

Figure 1 Power Dissipation vs. Ambient Temperature

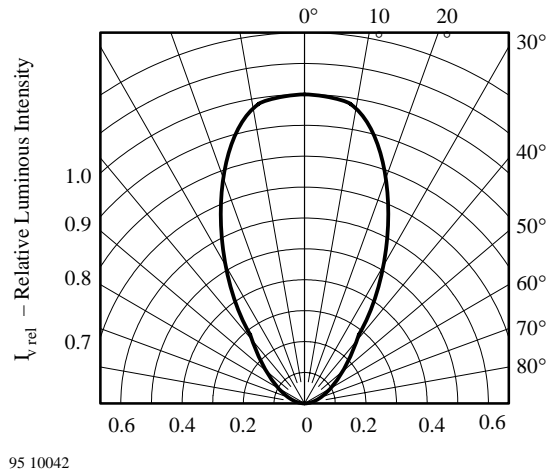

Figure 4 Rel. Luminous Intensity vs. Angular Displacement

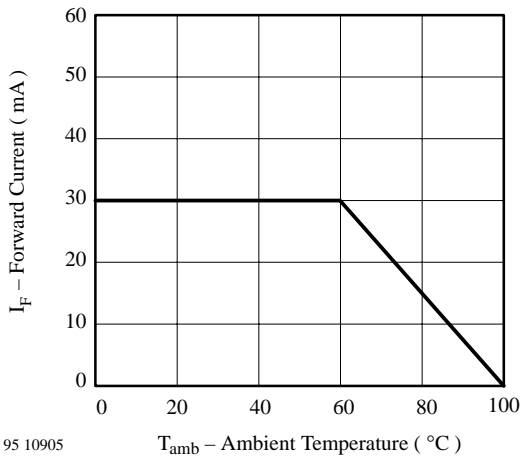

Figure 2 Forward Current vs. Ambient Temperature

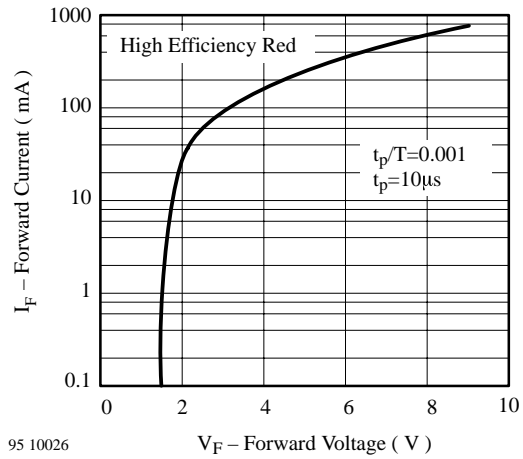

Figure 5 Forward Current vs. Forward Voltage

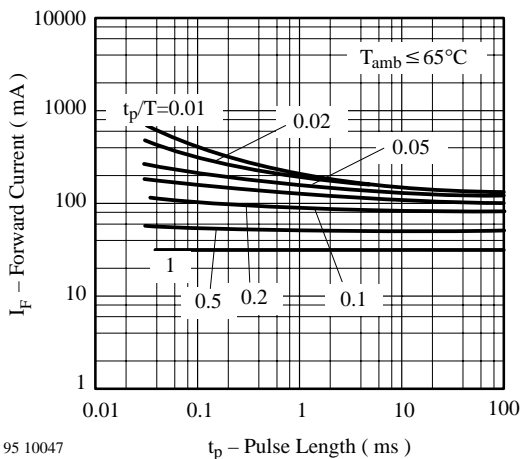

Figure 3 Forward Current vs. Pulse Length

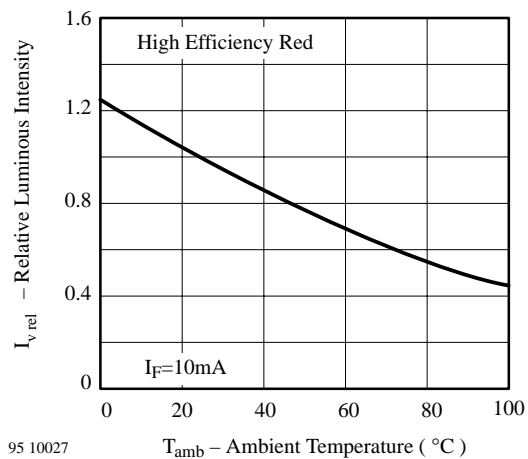

Figure 6 Rel. Luminous Intensity vs. Ambient Temperature

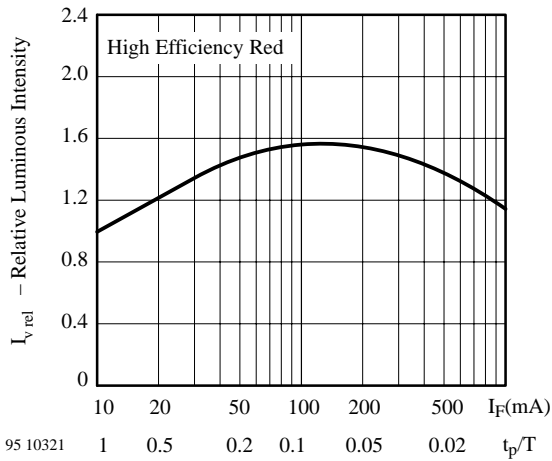

Figure 7 Rel. Lumin. Intensity vs. Forw. Current/Duty Cycle

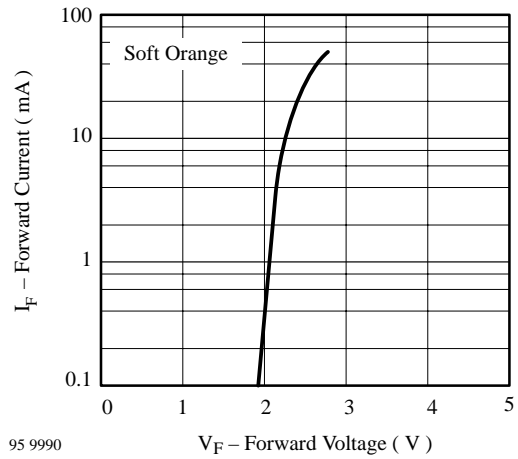

Figure 10 Forward Current vs. Forward Voltage

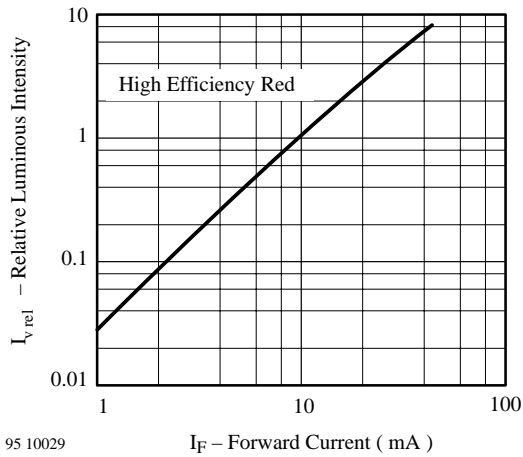

Figure 8 Relative Luminous Intensity vs. Forward Current

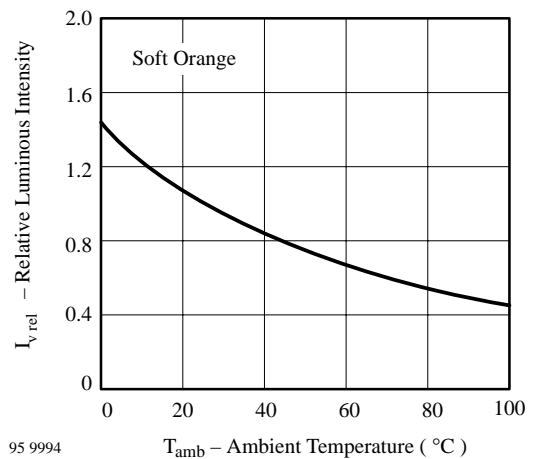

Figure 11 Rel. Luminous Intensity vs. Ambient Temperature

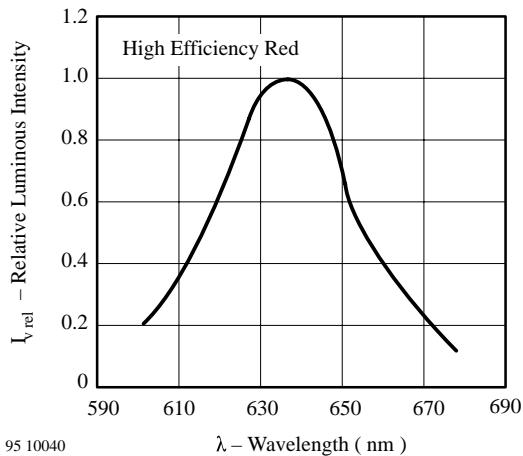

Figure 9 Relative Luminous Intensity vs. Wavelength

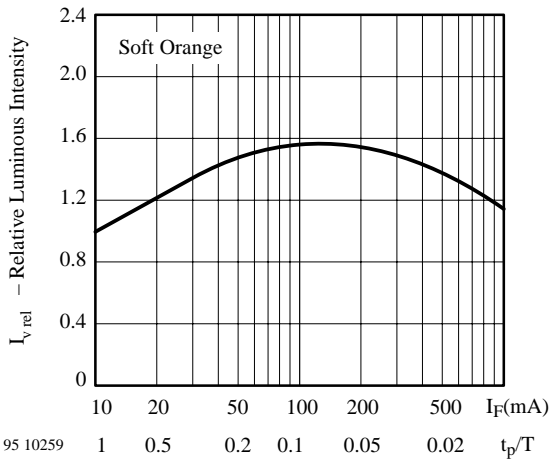

Figure 12 Rel. Lumin. Intensity vs. Forw. Current/Duty Cycle

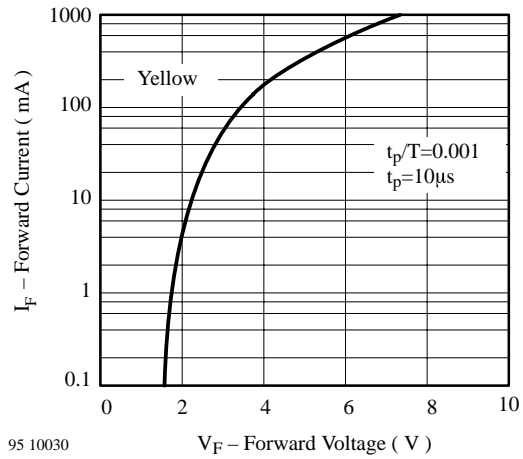

Figure 15 Rel. Luminous Intensity vs. Ambient Temperature

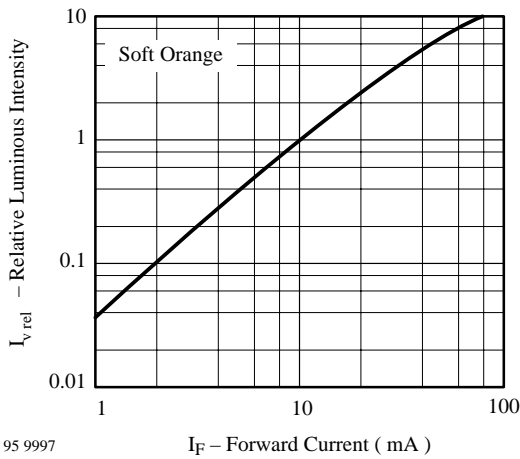

Figure 13 Relative Luminous Intensity vs. Forward Current

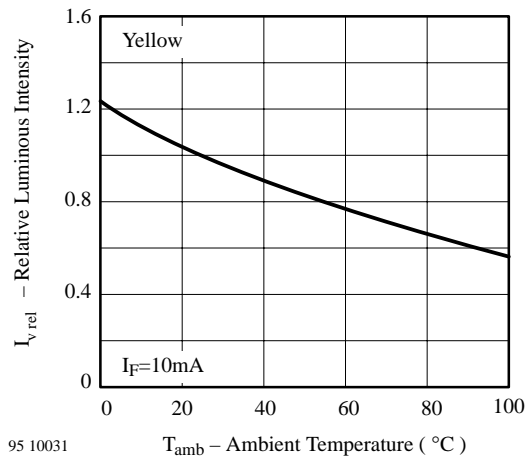

Figure 16 Rel. Luminous Intensity vs. Ambient Temperature

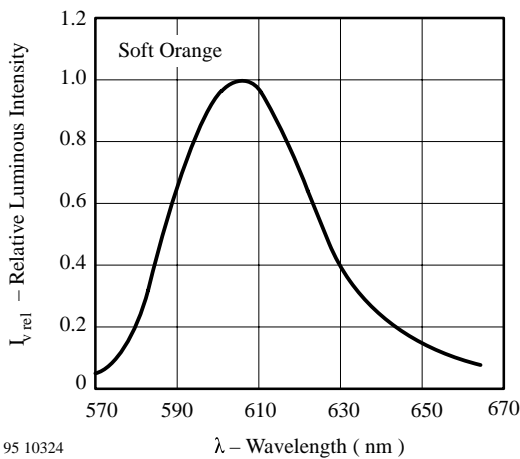

Figure 14 Relative Luminous Intensity vs. Wavelength

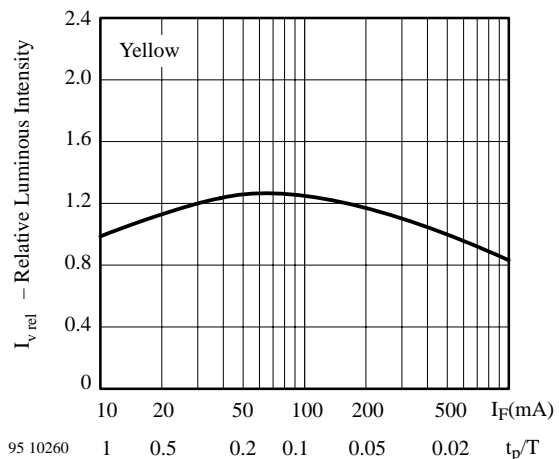

Figure 17 Rel. Lumin. Intensity vs. Forw. Current/Duty Cycle

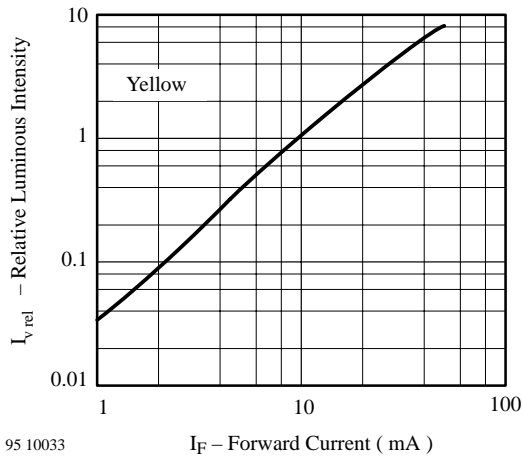

Figure 18 Relative Luminous Intensity vs. Forward Current

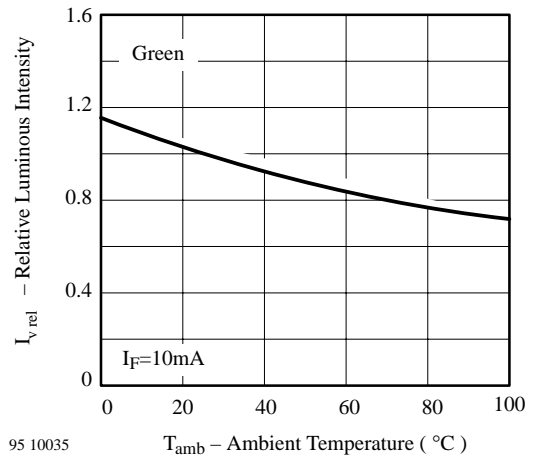

Figure 21 Rel. Luminous Intensity vs. Ambient Temperature

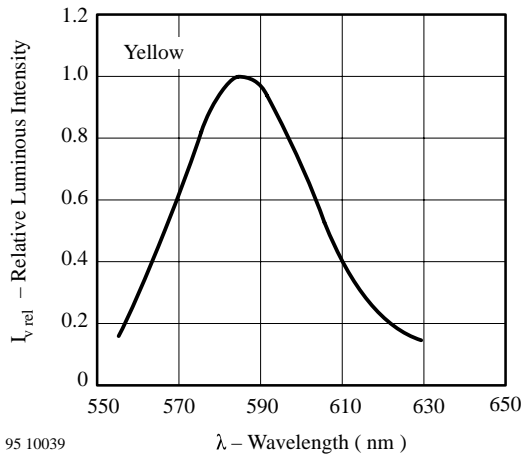

Figure 19 Relative Luminous Intensity vs. Wavelength

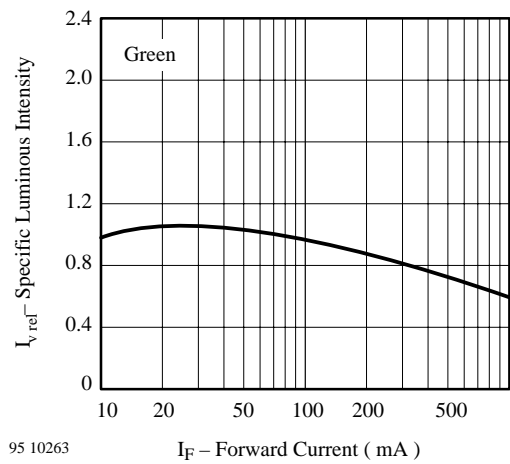

Figure 22 Specific Luminous Intensity vs. Forward Current

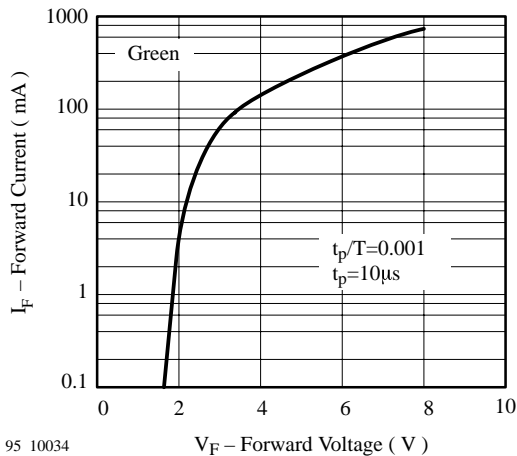

Figure 20 Forward Current vs. Forward Voltage

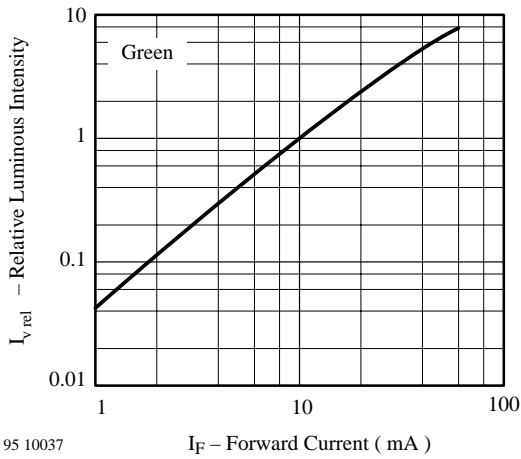

Figure 23 Relative Luminous Intensity vs. Forward Current

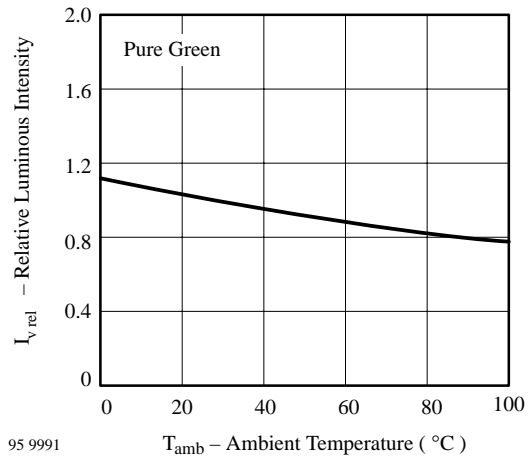

Figure 26 Rel. Luminous Intensity vs. Ambient Temperature

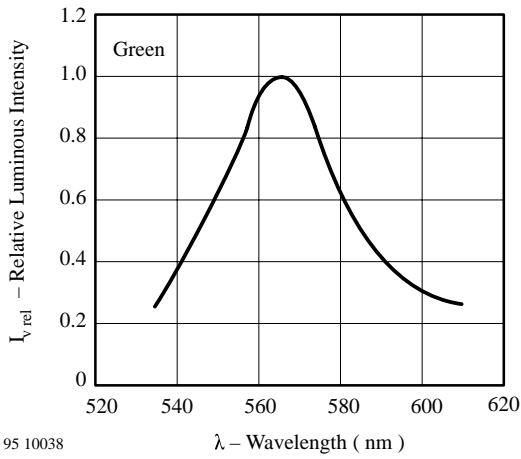

Figure 24 Relative Luminous Intensity vs. Wavelength

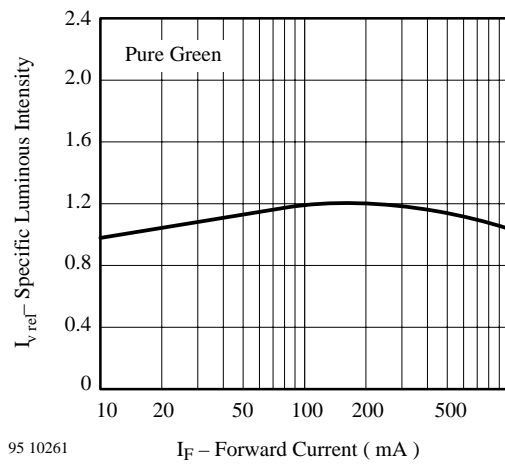

Figure 27 Specific Luminous Intensity vs. Forward Current

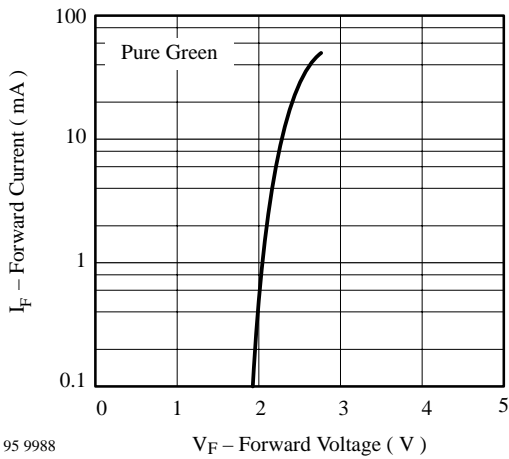

Figure 25 Forward Current vs. Forward Voltage



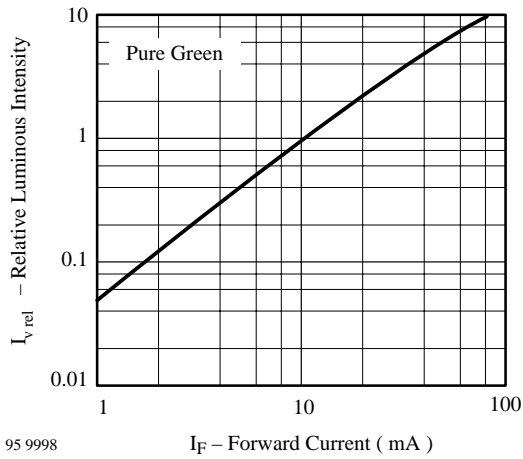

Figure 28 Relative Luminous Intensity vs. Forward Current

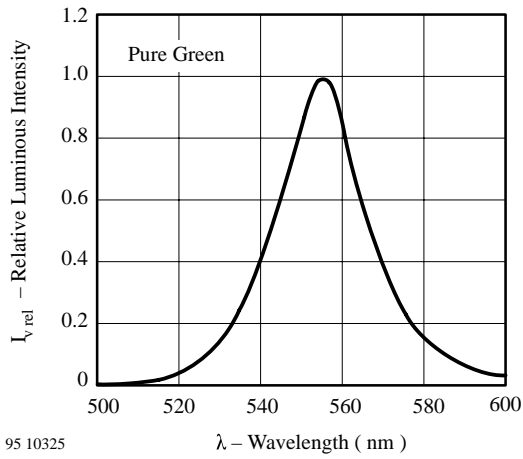
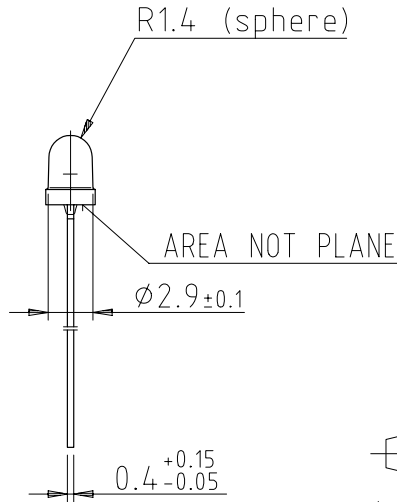
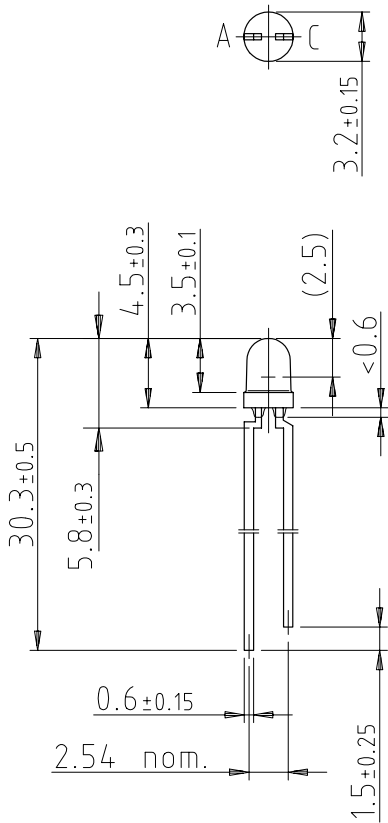

Figure 29 Relative Luminous Intensity vs. Wavelength

Dimensions in mm



95 10913

technical drawings according to DIN specifications



## Ozone Depleting Substances Policy Statement

It is the policy of **Vishay Semiconductor GmbH** to

1. Meet all present and future national and international statutory requirements.
2. Regularly and continuously improve the performance of our products, processes, distribution and operating systems with respect to their impact on the health and safety of our employees and the public, as well as their impact on the environment.

It is particular concern to control or eliminate releases of those substances into the atmosphere which are known as ozone depleting substances (ODSs).

The Montreal Protocol (1987) and its London Amendments (1990) intend to severely restrict the use of ODSs and forbid their use within the next ten years. Various national and international initiatives are pressing for an earlier ban on these substances.

**Vishay Semiconductor GmbH** has been able to use its policy of continuous improvements to eliminate the use of ODSs listed in the following documents.

1. Annex A, B and list of transitional substances of the Montreal Protocol and the London Amendments respectively
2. Class I and II ozone depleting substances in the Clean Air Act Amendments of 1990 by the Environmental Protection Agency (EPA) in the USA
3. Council Decision 88/540/EEC and 91/690/EEC Annex A, B and C (transitional substances) respectively.

**Vishay Semiconductor GmbH** can certify that our semiconductors are not manufactured with ozone depleting substances and do not contain such substances.

**We reserve the right to make changes to improve technical design and may do so without further notice.**

Parameters can vary in different applications. All operating parameters must be validated for each customer application by the customer. Should the buyer use Vishay-Telefunken products for any unintended or unauthorized application, the buyer shall indemnify Vishay-Telefunken against all claims, costs, damages, and expenses, arising out of, directly or indirectly, any claim of personal damage, injury or death associated with such unintended or unauthorized use.

Vishay Semiconductor GmbH, P.O.B. 3535, D-74025 Heilbronn, Germany  
Telephone: 49 (0)7131 67 2831, Fax number: 49 (0)7131 67 2423