

Description

The μPD28C04 is a 4,096-bit electrically erasable and programmable read-only memory (EEPROM) organized as 512 x 8 bits and fabricated with an advanced CMOS process for high performance and low power consumption.

The device operates from a single +5-volt power supply and provides a $\overline{\text{DATA}}$ polling function to indicate the precise end of write cycles. Additional features include chip erase, auto erase and programming cycles. The μPD28C04 is available in standard 24-pin plastic DIP or miniflat packaging.

Features

- Fast access times of 200 and 250 ns maximum
- Single +5-volt power supply
- Chip erase feature
- Auto erase and programming at 10 ms maximum
- $\overline{\text{DATA}}$ polling verification
- Low power dissipation
 - 50 mA max (active)
 - 100 μA max (standby)
- Endurance: 100,000 erase/write cycles per byte
- TTL-compatible inputs and outputs
- Three-state outputs
- Advanced CMOS technology
- 24-pin plastic DIP or miniflat packaging

Ordering Information

Part Number	Access Time (max)	Package
μPD28C04C-20	200 ns	24-pin plastic DIP
C-25	250 ns	
μPD28C04G-20	200 ns	24-pin plastic miniflat
G-25	250 ns	

Pin Configuration

24-Pin Plastic DIP or Miniflat

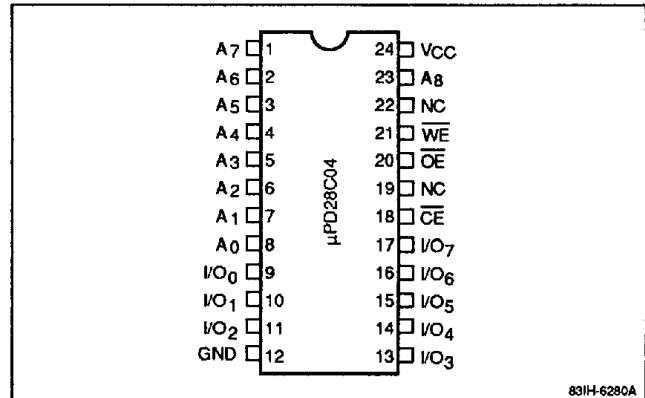

27a

Pin Identification

Symbol	Function
A ₀ - A ₈	Address inputs
I/O ₀ - I/O ₇	Data inputs/outputs
$\overline{\text{CE}}$	Chip enable
$\overline{\text{OE}}$	Output enable
$\overline{\text{WE}}$	Write enable
GND	Ground
V _{CC}	+5-volt power supply
NC	No connection



μPD28C04

Absolute Maximum Ratings

Supply voltage, V_{CC}	- 0.6 to +7.0 V
Input voltage, V_{IH}	- 0.6 to +7.0 V
Input voltage, V_{I3} (\overline{OE})	- 0.6 to +16.5 V
Output voltage, V_O	- 0.6 to +7.0 V
Operating temperature, T_{OPT}	- 10 to +85°C
Storage temperature, T_{STG}	- 65 to +125°C

Exposure to Absolute Maximum Ratings for extended periods may affect device reliability; exceeding the ratings could cause permanent damage. The device should be operated within the limits specified under DC and AC Characteristics.

Recommended Operating Conditions

Parameter	Symbol	Min	Typ	Max	Unit
Supply voltage	V_{CC}	4.5	5.0	5.5	V
Input voltage, high	V_{IH}	2.0		$V_{CC} + 0.3$	V
Input voltage, low	V_{IL}	- 0.3		0.8	V
Ambient temperature	T_A	0		70	°C

Capacitance

$T_A = 25^\circ\text{C}; f = 1 \text{ MHz}; V_{IN} \text{ and } V_{OUT} = 0 \text{ V}$

Parameter	Symbol	Min	Typ	Max	Unit
Input capacitance	C_I		7	12	pF
Output capacitance	C_O			10	pF

Truth Table

Function	\overline{CE}	\overline{OE}	\overline{WE}	I/O	I_{CC}
Read	V_{IL}	V_{IL}	V_{IH}	D_{OUT}	Active
Standby and write inhibit	V_{IH}	X	X	High-Z	Standby
Write	V_{IL}	V_{IH}	V_{IL}	D_{IN}	Active
Chip erase	V_{IL}	V_{IHH}	V_{IL}	$D_{IN} = V_{IH}$	Active
Write inhibit	X	V_{IL}	X	—	—
	X	X	V_{IH}	—	—

Notes:

- (1) X can be either V_{IL} or V_{IH} .
- (2) $V_{IHH} = +15 \pm 0.5 \text{ V}$.

Block Diagram

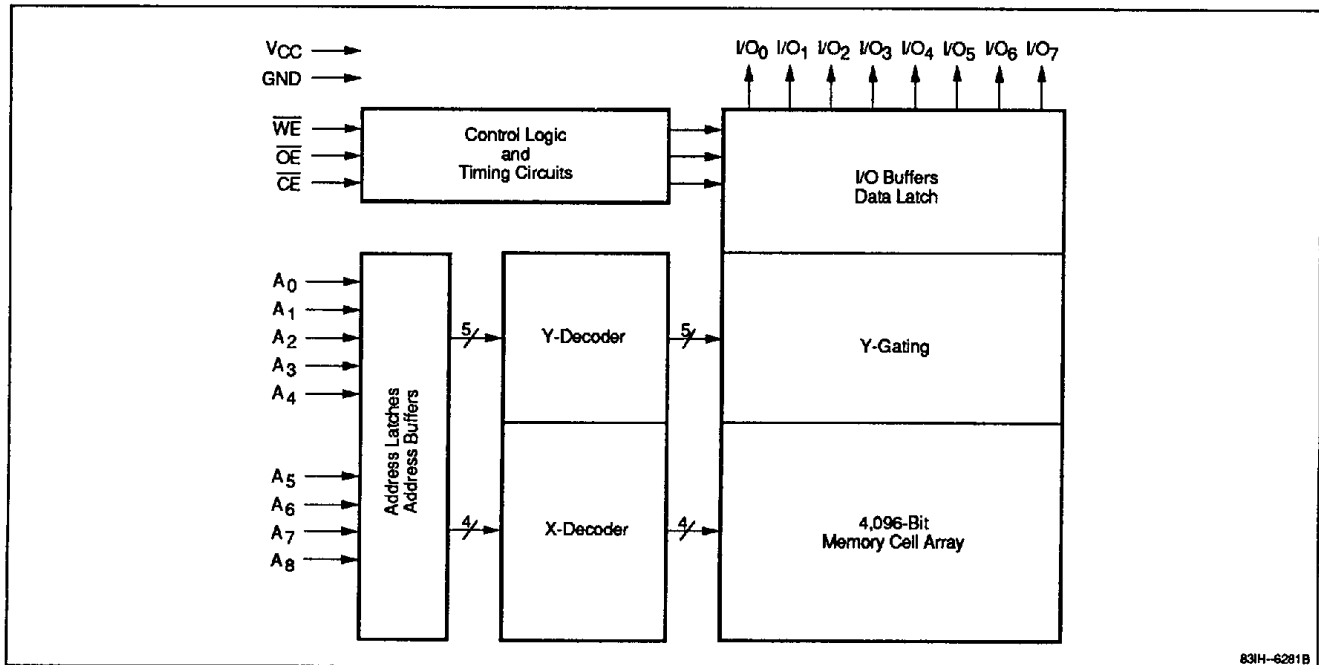

831H-6281B

DC Characteristics

$T_A = 0 \text{ to } +70^\circ\text{C}; V_{CC} = +5.0\text{V} \pm 10\%$

Parameter	Symbol	Min	Typ	Max	Unit	Test Conditions
Output voltage, high	V_{OH1}	2.4			V	$I_{OH} = -400 \mu\text{A}$
	V_{OH2}	$V_{CC} - 0.7$			V	$I_{OH} = -100 \mu\text{A}$
Output voltage, low	V_{OL}			0.45	V	$I_{OL} = 2.1 \text{ mA}$
Output leakage current	I_{LO}			10	μA	$V_{OUT} = 0 \text{ to } V_{CC}$
Input leakage current	I_{LI}			10	μA	$V_{IN} = 0 \text{ to } V_{CC}$
V_{CC} current (active)	I_{CCA1}			20	mA	$\overline{CE} = V_{IL}; V_{IN} = V_{IH}$
	I_{CCA2}			50	mA	$f = 5 \text{ MHz}; I_{OUT} = 0 \text{ mA}$
V_{CC} current (standby)	I_{CCS1}			1	mA	$\overline{CE} = V_{IH}$
	I_{CCS2}			100	μA	$\overline{CE} = V_{CC}; V_{IN} = 0 \text{ V to } V_{CC}$

AC Characteristics

$T_A = 0 \text{ to } +70^\circ\text{C}; V_{CC} = +5.0\text{V} \pm 10\%$

27a

Parameter	Symbol	μPD28C04-20		μPD28C04-25		Unit	Test Conditions
		Min	Max	Min	Max		
Read Operation							
Address to output delay	t_{ACC}		200		250	ns	$\overline{CE} = \overline{OE} = V_{IL}; \overline{WE} = V_{IH}$
\overline{CE} to output delay	t_{CE}		200		250	ns	$\overline{OE} = V_{IL}; \overline{WE} = V_{IH}$
\overline{CE} high to output float	t_{DFC}	0	60	0	80	ns	$\overline{OE} = V_{IL}; \overline{WE} = V_{IH}$
\overline{OE} high to output float	t_{DFO}	0	60	0	80	ns	$\overline{CE} = V_{IL}; \overline{WE} = V_{IH}$
\overline{OE} to output delay	t_{OE}	10	75	10	100	ns	$\overline{CE} = V_{IL}; \overline{WE} = V_{IH}$
Output hold time from address change	t_{OHA}	0		0		ns	$\overline{CE} = \overline{OE} = V_{IL}; \overline{WE} = V_{IH}$ (Note 2)
Output hold time from rising edge of \overline{CE}	t_{OHC}	0		0		ns	$\overline{OE} = V_{IL}; \overline{WE} = V_{IH}$ (Note 2)
Output hold time from rising edge of \overline{OE}	t_{OHO}	0		0		ns	$\overline{CE} = V_{IL}; \overline{WE} = V_{IH}$
\overline{WE} hold time from rising edge of \overline{OE}	t_{WHO}	10		10		ns	$\overline{OE} = V_{IH}$
\overline{WE} setup time to \overline{CE}	t_{WSC}	10		10		ns	$\overline{CE} = V_{IH}$
\overline{WE} setup time to \overline{OE}	t_{WSO}	10		10		ns	$\overline{OE} = V_{IH}$
Write Operation							
Address hold time	t_{AH}	200		200		ns	
Address setup time	t_{AS}	10		10		ns	
\overline{CE} high after \overline{CE} -controlled write cycle	t_{CEH}	9.9		9.9		ms	
Write hold time	t_{CH}	0		0		ns	
Write setup time	t_{CS}	0		0		ns	

μPD28C04



AC Characteristics (cont)

Parameter	Symbol	μPD28C04-20		μPD28C04-25		Unit	Test Conditions
		Min	Max	Min	Max		
Write Operation (cont)							
\overline{CE} pulse width	t_{CW}	150		150		ns	
Data hold time	t_{DH}	20		20		ns	
Data setup time	t_{DS}	100		100		ns	
Data valid time	t_{DV}		300		300	ns	
\overline{OE} high hold time	t_{OEHL}	10		10		ns	
\overline{OE} high setup time	t_{OES}	10		10		ns	
Write cycle time	t_{WC}	10		10		ms	
\overline{WE} high after \overline{WE} -controlled write cycle	t_{WEHL}	9.9		9.9		ms	
\overline{WE} pulse width	t_{WPL}	150		150		ns	
\overline{WE} high hold time	t_{WPH}	50		50		ns	
Chip Erase Operation							
\overline{CE} hold time	t_{ECH}	5		5		μs	
\overline{CE} setup time	t_{ECS}	500		500		ns	
Data hold time	t_{EDH}	100		100		ns	
Data setup time	t_{EDS}	500		500		ns	
\overline{OE} hold time	t_{EOEH}	$t_{ECH} + 3$		$t_{ECH} + 3$		μs	
\overline{OE} setup time	t_{EOES}	500		500		ns	
\overline{WE} pulse width	t_{EWP}	10		10		ms	

Notes:

- (1) See figure 1 for the output load. Input rise and fall time ≤ 20 ns; input pulse levels = 0.45 and 2.4 V; timing measurement reference levels = 0.8 and 2.0 V for both inputs and outputs.
- (2) Output hold time is specified from address, \overline{OE} or \overline{CE} , whichever goes invalid first.

Figure 1. Output Load

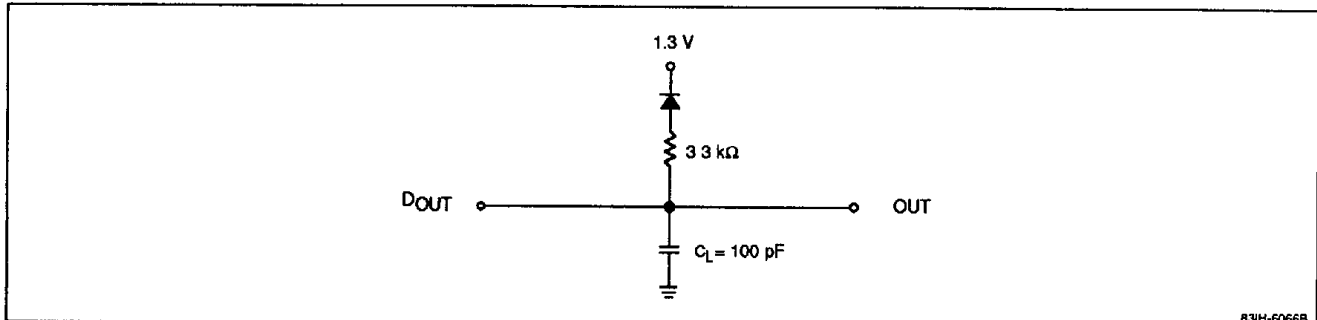

83H-6068

Timing Waveforms

Read Cycle

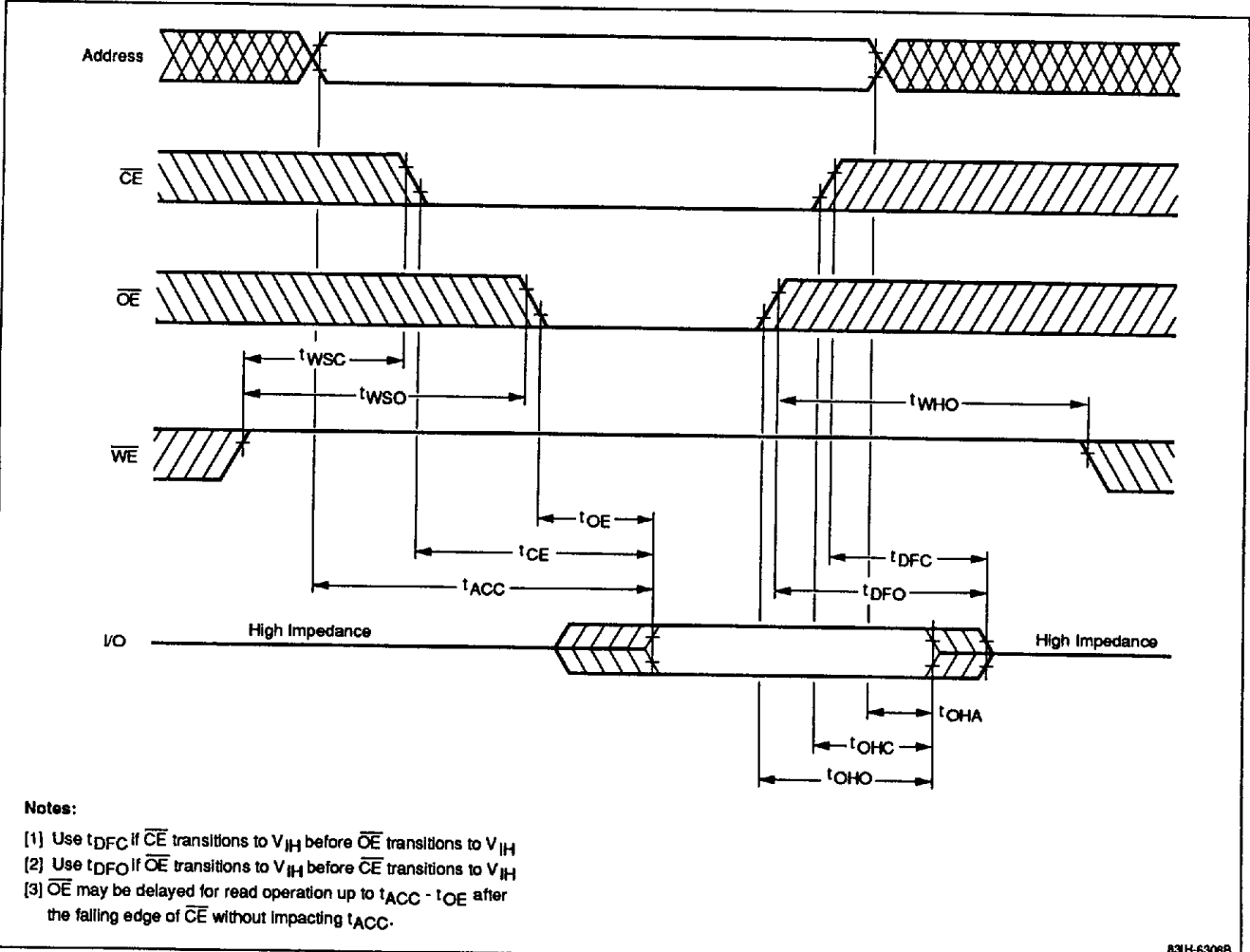

27a

831H-6306B

μPD28C04

Timing Waveforms (cont)

WE-Controlled Write Cycle

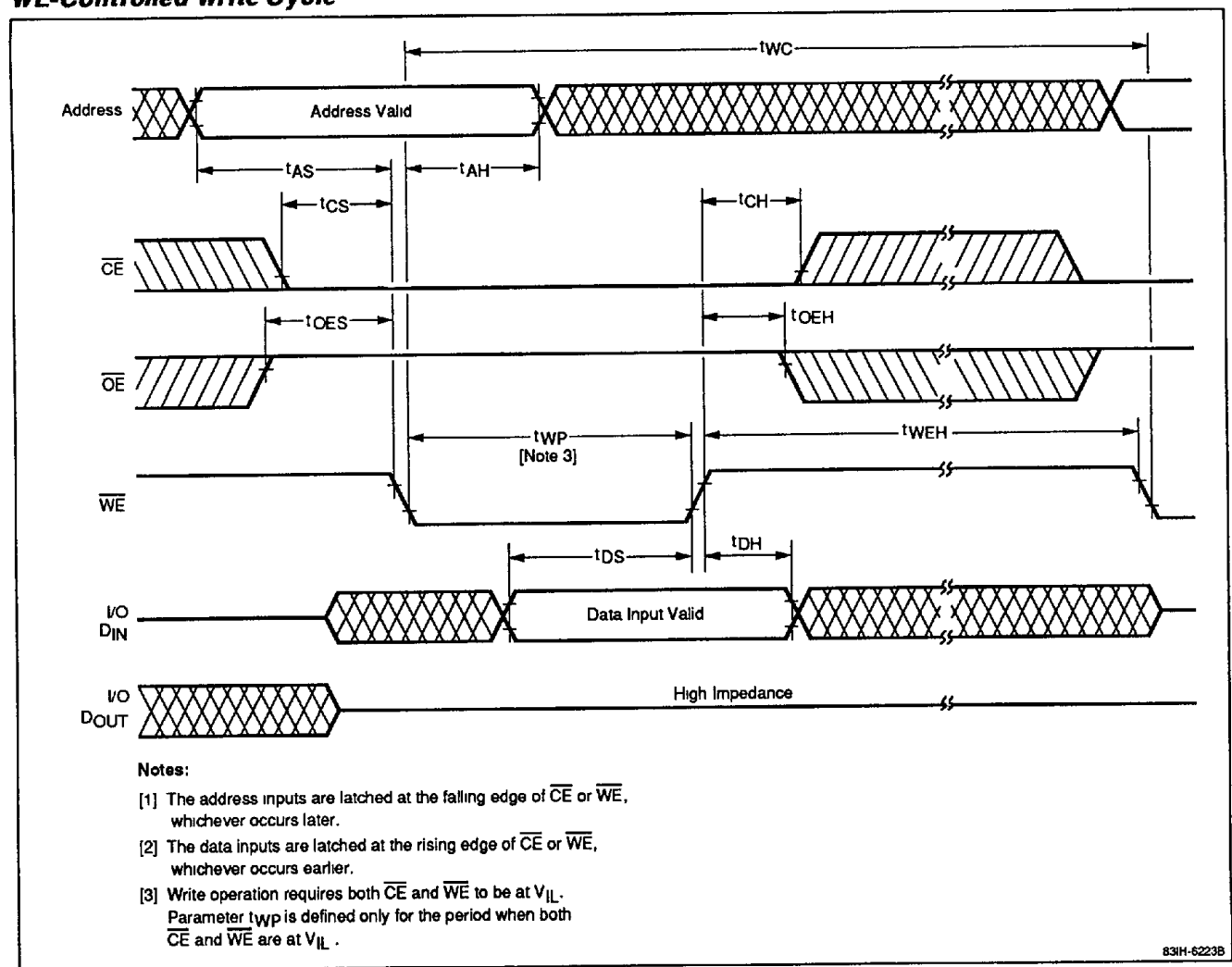

Timing Waveforms (cont)

\overline{CE} -Controlled Write Cycle

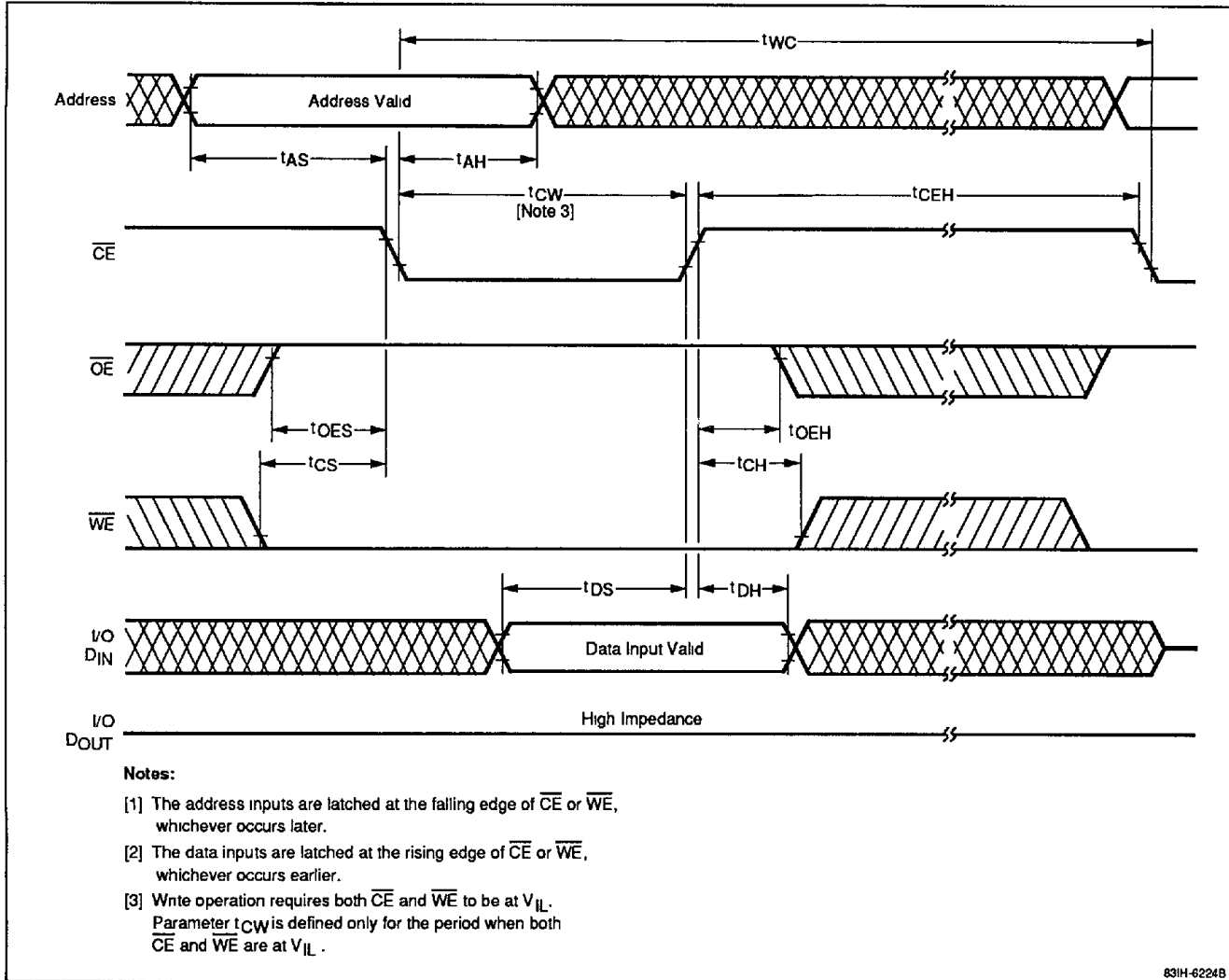

27a

831H-6224B

Timing Waveforms (cont)

Chip Erase Cycle

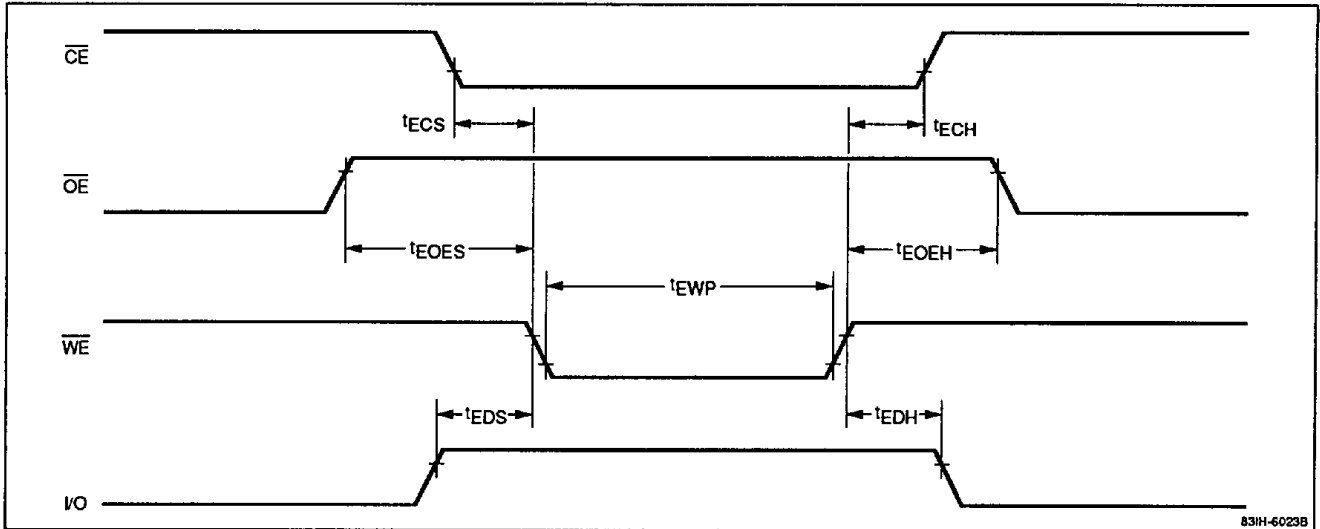

Read Cycle

Both \overline{CE} and \overline{OE} must be at V_{IL} in order to read stored data. While the device is executing read cycles, bringing either of these inputs to V_{IH} will place the outputs in a state of high impedance. This two-line output control allows bus contention to be eliminated in the system application.

Byte Write Cycle

Low levels on \overline{CE} and \overline{WE} and a high level on \overline{OE} place the $\mu\text{PD28C04}$ in write operation. The write address inputs are latched by the falling edge of either \overline{CE} or \overline{WE} , whichever occurs later. The data inputs are latched by the rising edge of either \overline{CE} or \overline{WE} , whichever occurs earlier. Once byte write cycles begin executing, internal circuits assume all timing control and the byte being addressed is automatically erased and then programmed. The operation is completed within a write cycle time (t_{WC}) of 10 ms.

Chip Erase Cycle

All bytes of the $\mu\text{PD28C04}$ can be erased simultaneously by making \overline{CE} and \overline{WE} fall to V_{IL} after \overline{OE} has been increased to V_{IHH} (15 ± 0.5 V). The address inputs are "don't care," but the data inputs must all be driven to V_{IH} before the chip erase cycle begins.

\overline{DATA} Polling Feature

This feature supports system software by indicating the precise end of byte write cycles. \overline{DATA} polling can be used to reduce the total programming time of the $\mu\text{PD28C04}$ to a minimum value, which varies with the system environment.

While internal automatic write cycles are in progress, any attempt to read data at the last externally supplied address location will result in inverted data on pin I/O₇ (for example, if write data = 1xxx xxxx, then read data = 0xxx xxxx). Once the write cycle is complete, a read cycle will result in true data being output on I/O₇.

Write Protection Features

The $\mu\text{PD28C04}$ provides three features to prevent invalid write cycles:

- Noise immunity, where write operation is inhibited when the \overline{WE} pulse width is 20 ns or less.
- Supply voltage-level detection, where write operation is inhibited when V_{CC} is 2.5 volts or less.
- Write protection logic, where write operation is inhibited if \overline{OE} is held low or \overline{CE} or \overline{WE} is held high during power-on or -off of the V_{CC} supply voltage.

27a