

Single Phase Rectifier Bridge

$I_{dAVM} = 124 \text{ A}$
 $V_{RRM} = 1200-1800 \text{ V}$

V_{RSM} V	V_{RRM} V	Type
900	800	VBO 125-08NO7
1200	1200	VBO 125-12NO7
1400	1400	VBO 125-14NO7
1600	1600	VBO 125-16NO7
1800	1800	VBO 125-18NO7

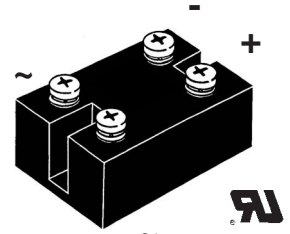
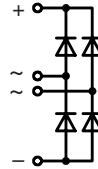

Symbol	Conditions	Maximum Ratings	
I_{dAVM}	$T_C = 85^\circ\text{C}$, module	124	A
I_{FSM}	$T_{VJ} = 45^\circ\text{C}$; $V_R = 0$	t = 10 ms (50 Hz), sine	1800 A
		t = 8.3 ms (60 Hz), sine	1950 A
I^2t	$T_{VJ} = T_{VJM}$; $V_R = 0$	t = 10 ms (50 Hz), sine	1600 A ² s
		t = 8.3 ms (60 Hz), sine	1800 A ² s
T_{VJ}	$T_{VJ} = T_{VJM}$; $V_R = 0$	t = 10 ms (50 Hz), sine	12800 A ² s
		t = 8.3 ms (60 Hz), sine	13600 A ² s
T_{VJM}		-40...+150	°C
T_{stg}		150	°C
V_{ISOL}	50/60 Hz, RMS $I_{ISOL} \leq 1 \text{ mA}$	t = 1 min	2500 V~
		t = 1 s	3000 V~
M_d	Mounting torque (M5) Terminal connection torque (M5)	5 ±15%	Nm
		44 ±15%	lb.in.
M_d	Mounting torque (M5) Terminal connection torque (M5)	5 ±15%	Nm
		44 ±15%	lb.in.
Weight	typ.	225	g

Features

- Package with screw terminals
- Isolation voltage 3000 V~
- Planar passivated chips
- Blocking voltage up to 1800 V
- Low forward voltage drop
- UL registered E 72873

Applications

- Supplies for DC power equipment
- Input rectifiers for PWM inverter
- Battery DC power supplies
- Field supply for DC motors

Advantages

- Easy to mount with two screws
- Space and weight savings
- Improved temperature and power cycling

Dimensions in mm (1 mm = 0.0394")

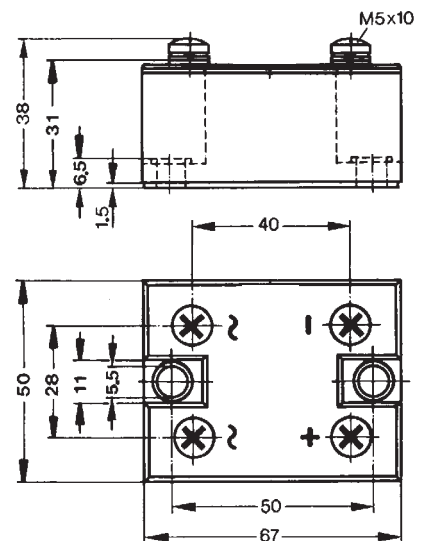

Symbol	Conditions	Characteristic Values	
I_R	$V_R = V_{RRM}$; $V_R = V_{RRM}$	$T_{VJ} = 25^\circ\text{C}$	≤ 0.3 mA
		$T_{VJ} = T_{VJM}$	≤ 8.0 mA
V_F	$I_F = 150 \text{ A}$;	$T_{VJ} = 25^\circ\text{C}$	≤ 1.3 V
V_{T0}	For power-loss calculations only		0.8 V
r_T	$T_{VJ} = T_{VJM}$		3 mΩ
R_{thJC}	per diode; 180° per module; 180°		0.83 K/W
			0.138 K/W
R_{thJK}	per diode; 180° per module; 180°		1.13 K/W
			0.188 K/W

Data according to IEC 60747 refer to a single diode unless otherwise stated.

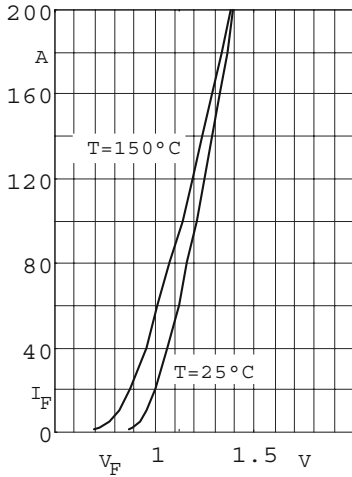

Fig. 1 Forward current versus voltage drop per diode

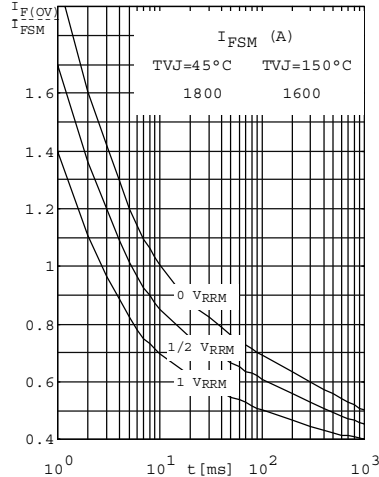

Fig. 2 Surge overload current per diode I_{FSM} ; Crest value. t: duration

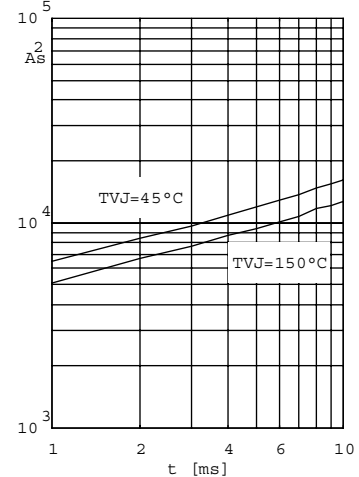

Fig. 3 $\int i^2 dt$ versus time (1-10ms) per diode or thyristor

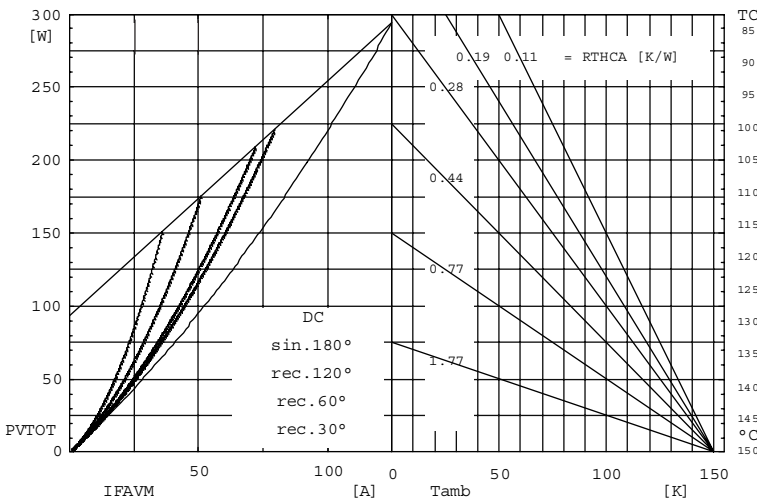

Fig. 4 Power dissipation versus direct output current and ambient temperature

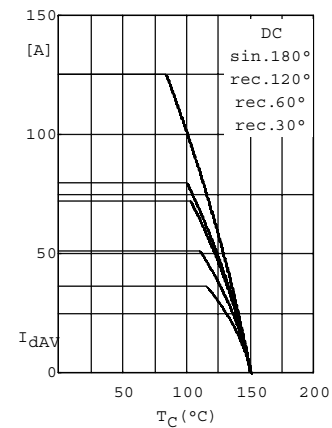

Fig.5 Maximum forward current at case temperature

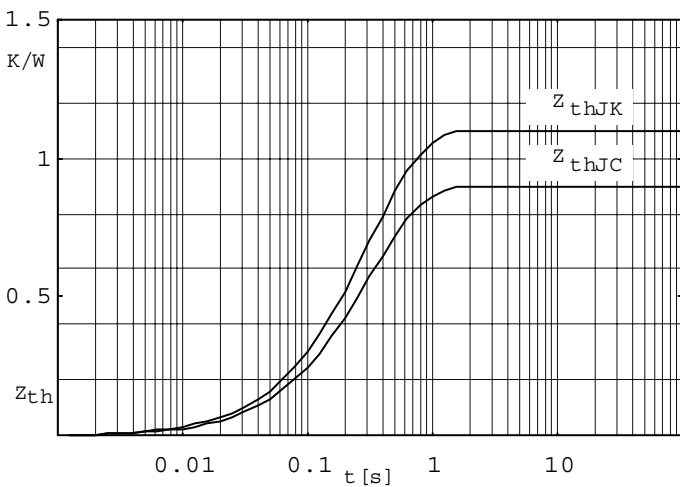

Fig. 6 Transient thermal impedance per diode or thyristor, calculated