

11.0-19.0 GHz GaAs MMIC Power Amplifier, QFN

Features

- ✕ 17.0 dB Small Signal Gain
- ✕ +27.0 dBm Saturated Output Power
- ✕ SMD, 3x3 mm QFN Package
- ✕ RoHS Compliant
- ✕ 100% RF, DC and Output Power Testing



General Description

Mimix Broadband's two stage 11.0-19.0 GHz GaAs MMIC power amplifier has a small signal gain of 17.0 dB with a +27.0 dBm saturated output power. This MMIC uses Mimix Broadband's 0.15 μm GaAs PHEMT device model technology, and is based upon electron beam lithography to ensure high repeatability and uniformity. The device comes in a 3x3mm QFN Surface Mount Package offering excellent RF and thermal properties and is RoHS compliant. This device is well suited for Millimeter-wave Point-to-Point Radio, LMDS, SATCOM and VSAT applications.

Absolute Maximum Ratings

Supply Voltage (Vd)	+9.0 VDC
Supply Current (Id)	500 mA
Gate Bias Voltage (Vg)	+0.3 VDC
Input Power (Pin)	+17.0 dBm
Storage Temperature (Tstg)	-65 to +165 °C
Operating Temperature (Ta)	-55 to MTTF Table ¹
Channel Temperature (Tch)	MTTF Table ¹

(1) Channel temperature affects a device's MTTF. It is recommended to keep channel temperature as low as possible for maximum life.

Electrical Characteristics (Ambient Temperature T = 25 °C)

Parameter	Units	Min.	Typ.	Max.
Frequency Range (f)	GHz	11.0	-	19.0
Input Return Loss (S11)	dB	-	12.0	-
Output Return Loss (S22)	dB	-	8.0	-
Small Signal Gain (S21)	dB	-	17.0	-
Gain Flatness ($\Delta S21$)	dB	-	+/-1.0	-
Reverse Isolation (S12)	dB	-	40.0	-
Saturated Output Power (Psat)	dBm	-	+27.0	-
Drain Bias Voltage (Vd)	VDC	-	+5.0	+8.0
Gate Bias Voltage (Vg)	VDC	-1.0	-0.9	0.0
Supply Current (Id) (Vd=5.0V, Vg=-0.9V Typical)	mA	-	380	420

11.0-19.0 GHz GaAs MMIC Power Amplifier, QFN

January 2007 - Rev 26-Jan-07

XP1020-QE
RoHS

Power Amplifier Measurements

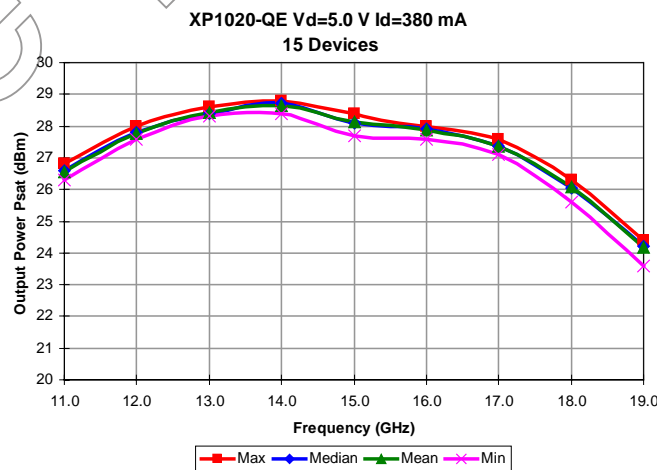
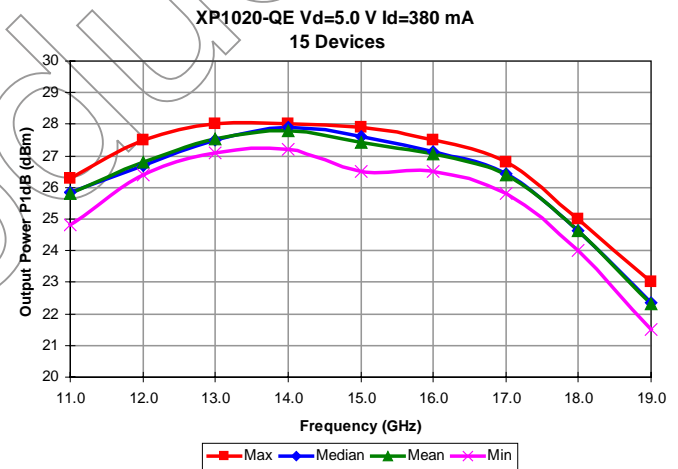
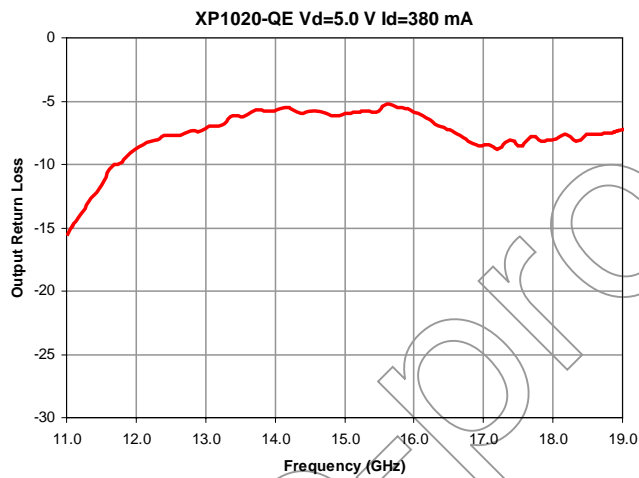
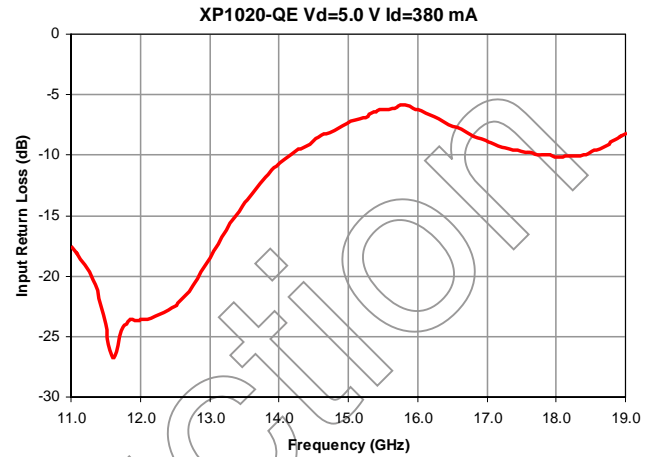
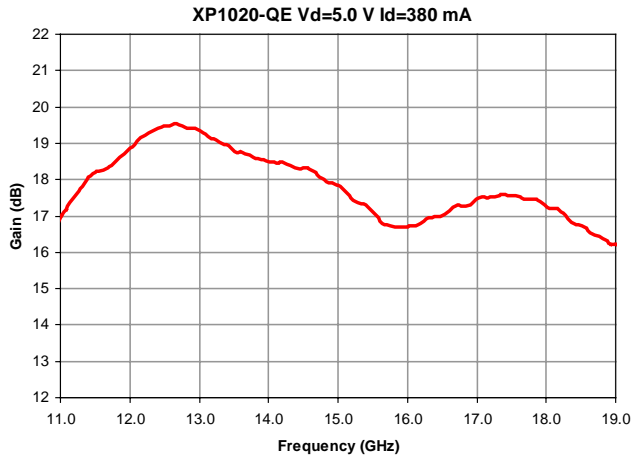

11.0-19.0 GHz GaAs MMIC Power Amplifier, QFN

January 2007 - Rev 26-Jan-07

PI020-QE
RoHS

Package Dimensions / Layout

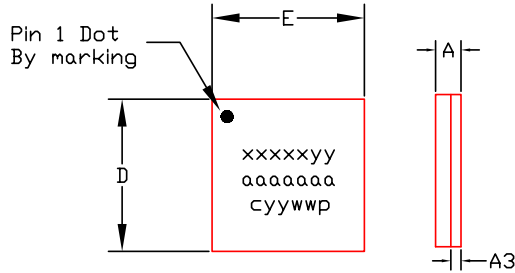

TOP VIEW

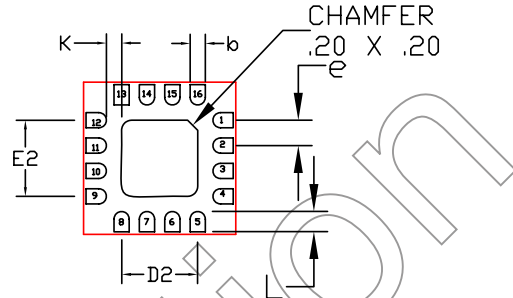

BOTTOM VIEW

Note:

1. ALL DIMENSIONS ARE IN mm.

	MIN	TYP	MAX
A	.45	.50	.55
A3	0.20 REF		
b	0.25	0.30	0.35
K	0.30	-	-
D	3.00 BSC		
E	3.00 BSC		
e	0.50		
D2	1.45	1.50	1.55
E2	1.45	1.50	1.55
L	0.35	0.40	0.45

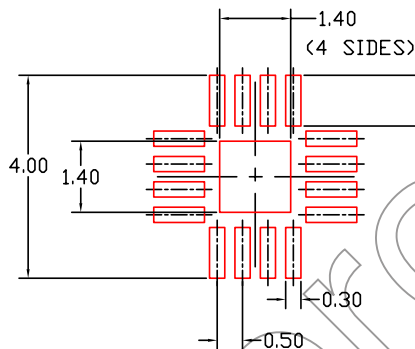

Functional Block Diagram / Board Layout

Bypass Capacitors - See App Note [2]

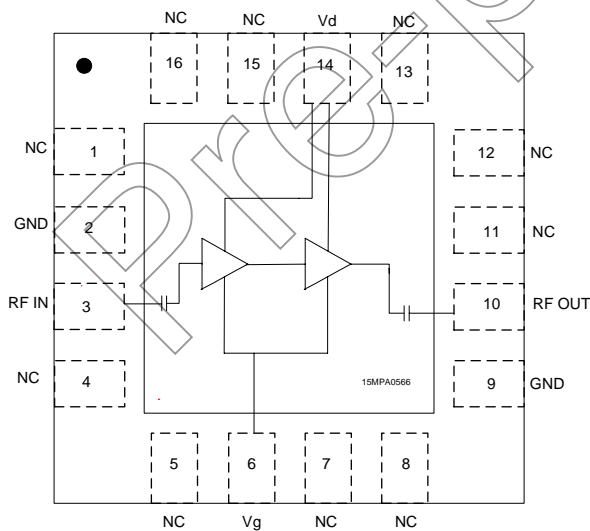

Pin	Description
2	Ground
3	RF In
6	Vg
9	Ground
10	RF Out
14	Vd

11.0-19.0 GHz GaAs MMIC Power Amplifier, QFN



January 2007 - Rev 26-Jan-07

XP1020-QE
RoHS

App Note [1] Biasing - It is recommended to bias the amplifier with $V_d=5.0V$ and $I_d=380mA$. It is also recommended to use active biasing to keep the currents constant as the RF power and temperature vary; this gives the most reproducible results. Depending on the supply voltage available and the power dissipation constraints, the bias circuit may be a single transistor or a low power operational amplifier, with a low value resistor in series with the drain supply used to sense the current. The gate of the pHEMT is controlled to maintain correct drain current and thus drain voltage. The typical gate voltage needed to do this is $-0.9V$. Typically the gate is protected with Silicon diodes to limit the applied voltage. Also, make sure to sequence the applied voltage to ensure negative gate bias is available before applying the positive drain supply.

App Note [2] Bias Arrangement -

Each DC pin (V_d and V_g) needs to have DC bypass capacitance ($\sim 0.01 \mu F$) as close to the package as possible.

MTTF Graphs

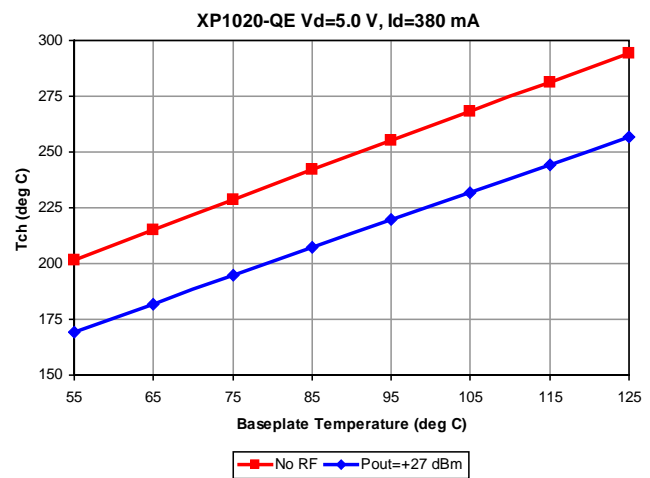
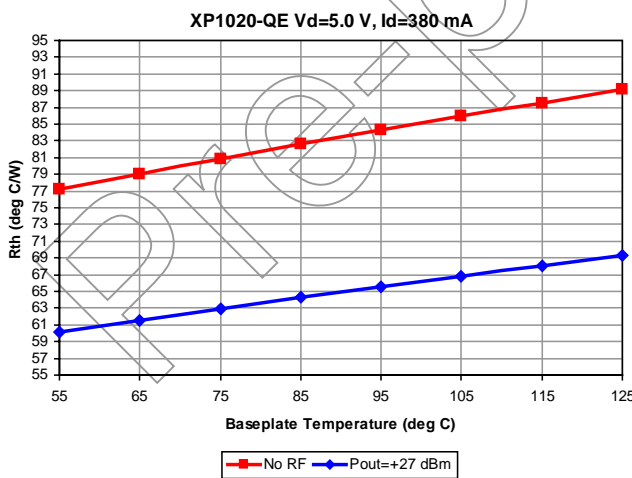
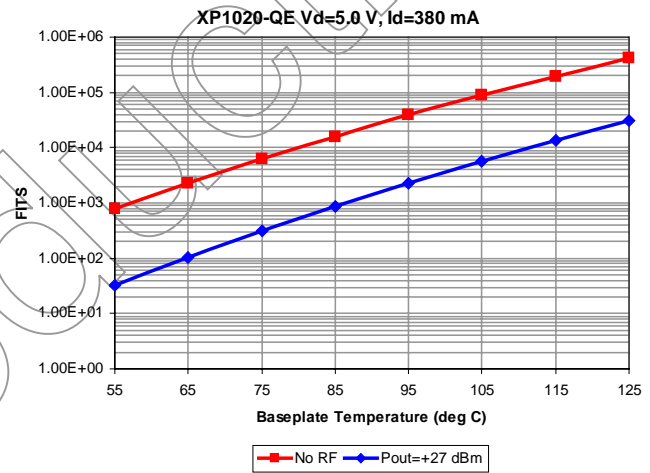
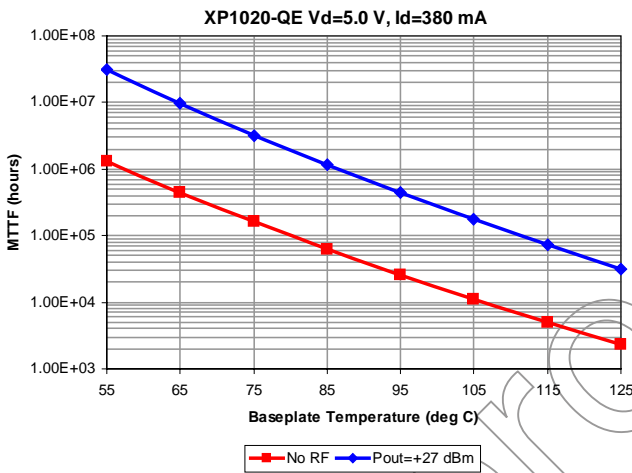

11.0-19.0 GHz GaAs MMIC Power Amplifier, QFN

Typical Application

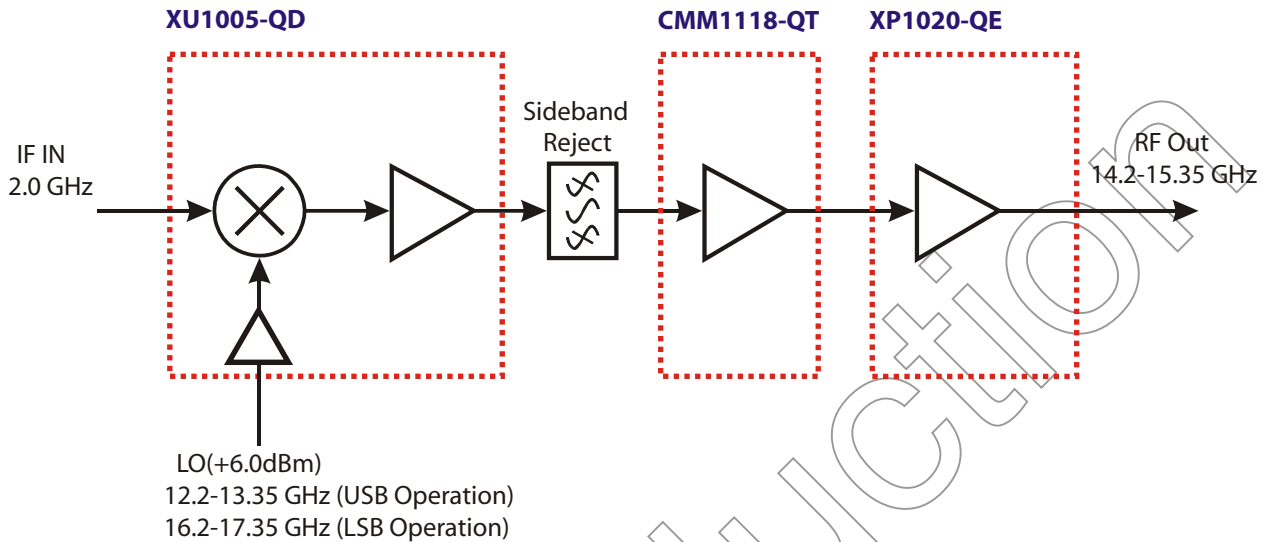

Mimix Broadband MMIC-based 11.0-18.0 GHz Transmitter Block Diagram

(Changing LO and IF frequencies as required allows design to operate as high as 18.0 GHz)

Mimix Broadband's 11.0-18.0 GHz XU1005-QD GaAs MMIC Transmitter can be used in saturated radio applications and linear modulation schemes up to 16 QAM. The transmitter can be used in upper and lower sideband applications from 11.0-18.0 GHz.

11.0-19.0 GHz GaAs MMIC Power Amplifier, QFN



January 2007 - Rev 26-Jan-07

XP1020-QE
RoHS

Handling and Assembly Information

CAUTION! - Mimix Broadband MMIC Products contain gallium arsenide (GaAs) which can be hazardous to the human body and the environment. For safety, observe the following procedures:

- Do not ingest.
- Do not alter the form of this product into a gas, powder, or liquid through burning, crushing, or chemical processing as these by-products are dangerous to the human body if inhaled, ingested, or swallowed.
- Observe government laws and company regulations when discarding this product. This product must be discarded in accordance with methods specified by applicable hazardous waste procedures.

Life Support Policy - Mimix Broadband's products are not authorized for use as critical components in life support devices or systems without the express written approval of the President and General Counsel of Mimix Broadband. As used herein: (1) Life support devices or systems are devices or systems which, (a) are intended for surgical implant into the body, or (b) support or sustain life, and whose failure to perform when properly used in accordance with instructions for use provided in the labeling, can be reasonably expected to result in a significant injury to the user. (2) A critical component is any component of a life support device or system whose failure to perform can be reasonably expected to cause the failure of the life support device or system, or to affect its safety or effectiveness.

Package Attachment - This packaged product from Mimix Broadband is provided as a rugged surface mount package compatible with high volume solder installation. Vacuum tools or other suitable pick and place equipment may be used to pick and place this part. Care should be taken to ensure that there are no voids or gaps in the solder connection so that good RF, DC and ground connections are maintained. Voids or gaps can eventually lead not only to RF performance degradation, but reduced reliability and life of the product due to thermal stress.

Typical Reflow Profiles

Reflow Profile	SnPb	Pb Free
Ramp Up Rate	3-4 °C/sec	3-4 °C/sec
Activation Time and Temperature	60-120 sec @ 140-160 °C	60-180 sec @ 170-200 °C
Time Above Melting Point	60-150 sec	60-150 sec
Max Peak Temperature	240 °C	265 °C
Time Within 5 °C of Peak	10-20 sec	10-20 sec
Ramp Down Rate	4-6 °C/sec	4-6 °C/sec

Mimix Lead-Free RoHS Compliant Program - Mimix has an active program in place to meet customer and governmental requirements for eliminating lead (Pb) and other environmentally hazardous materials from our products. All Mimix RoHS compliant components are form, fit and functional replacements for their non-RoHS equivalents. Lead plating of our RoHS compliant parts is 100% matt tin (Sn) over copper alloy and is backwards compatible with current standard SnPb low-temperature reflow processes as well as higher temperature (260°C reflow) "Pb Free" processes.

Part Number for Ordering

XP1020-QE-0N00
XP1020-QE-EV1

Description

Gold plated RoHS compliant 3x3 16L QFN surface mount package in bulk quantity
XP1020-QE evaluation board